

# NPort® 5100A Series

## 1-port RS-232/422/485 serial device servers



- > Only 1 W power consumption
- > Speedy 3-step web-based configuration
- > Surge protection for serial, Ethernet, and power lines
- > COM port grouping and UDP multicast applications
- > Screw connectors for secure installation
- > Real COM/TTY drivers for Windows and Linux
- > Standard TCP/IP interface and versatile TCP and UDP operation modes
- > Connect up to 8 TCP hosts



### Overview

The NPort® 5100A device servers are designed to make serial devices network-ready in an instant and give your PC software direct access to serial devices from anywhere on the network. The NPort® 5100A

device servers are ultra-lean, ruggedized, and user-friendly, making simple and reliable serial-to-Ethernet solutions possible.

### A Greener Serial-to-Ethernet Solution

The Moxa MiiNe is a small but powerful ARM-based serial-to-Ethernet SoC with RAM and Flash embedded. With the MiiNe inside, the NPort® 5100A series becomes the world's only device server with power consumption less than 1 W. The NPort® 5100A series saves at least 50% on power consumption compared to existing solutions

on the market, helping engineers meet the tough environmental compliance challenges found in today's industrial environments.



### Surge-Protected Serial, Ethernet, and Power Lines

Surge, which is typically caused by high voltages that result from switching and lightning transients, is a common threat to all electrical devices. Moxa's leading-edge surge immunity solution, which is applied to the NPort® 5100A's serial, power, and Ethernet lines, is tested and proven compliant with IEC 61000-4-5. This state-of-the-art

surge protection provides a robust serial-to-Ethernet solution that can protect electrical devices from voltage spikes and withstand electrically noisy environmental conditions.



### 3-step Web-Based Configuration

The NPort® 5100A's 3-step web-based configuration tool is straightforward and user-friendly. The NPort® 5100A's web console guides users through 3 simple configuration steps that are necessary to activate the serial-to-Ethernet application. With this speedy 3-step web-based configuration, a user only needs to spend an average of

30 seconds to complete the NPort® settings and enable the application, saving a great amount of time and effort.



### Easy to Troubleshoot

NPort® 5100A device servers support SNMP, which can be used to monitor all units over Ethernet. Each unit can be configured to send trap messages automatically to the SNMP manager when user-defined errors are encountered. For users who do not use SNMP manager, an

e-mail alert can be sent instead. Users can define the trigger for the alerts using Moxa's Windows utility, or the web console. For example, alerts can be triggered by a warm start, a cold start, or a password change.

**Appearance**

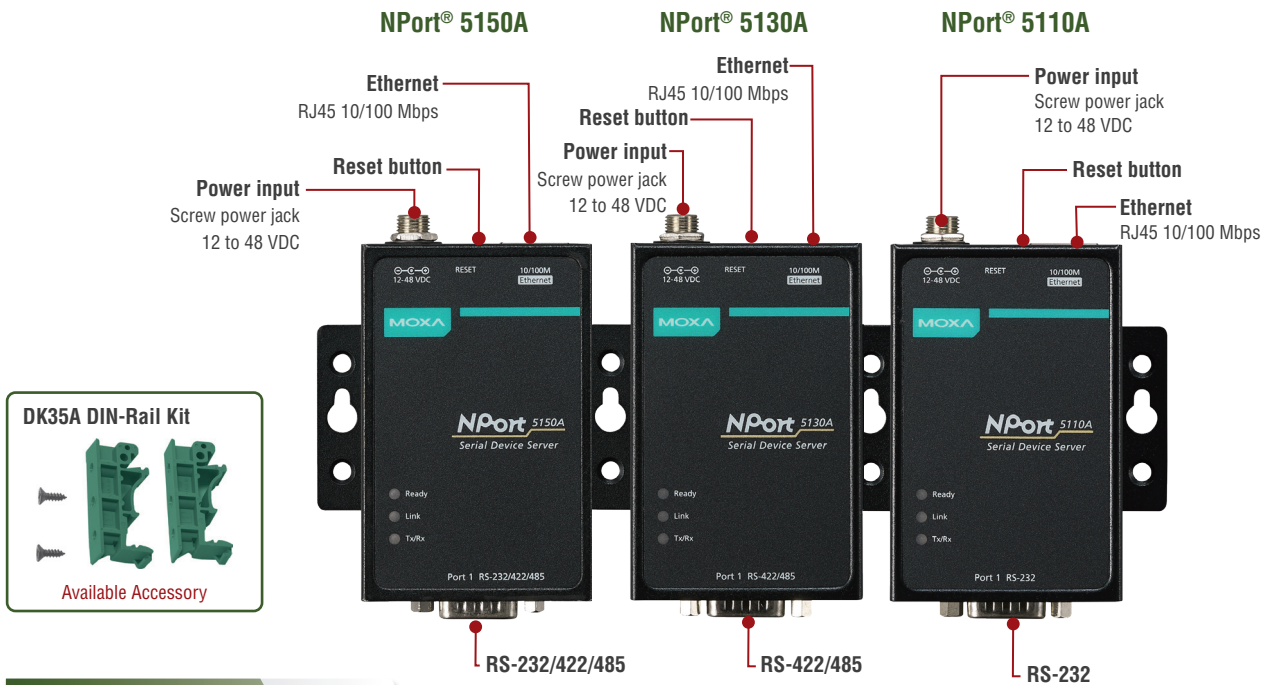

**Specifications**

**Ethernet Interface**

**Number of Ports:** 1  
**Speed:** 10/100 Mbps, auto MDI/MDIX  
**Connector:** 8-pin RJ45  
**Magnetic Isolation Protection:** 1.5 kV built-in

**Serial Interface**

**Number of Ports:** 1  
**Serial Standards:**  
 NPort 5110A: RS-232  
 NPort 5130A: RS-422/485  
 NPort 5150A: RS-232/422/485  
**Connector:** DB9 male  
**Serial Line Protection:** Level 1 surge, EN 61000-4-5  
**RS-485 Data Direction Control:** ADDC® (Automatic Data Direction Control)  
**Pull High/Low Resistor for RS-485:** 1 kΩ, 150 kΩ

**Serial Communication Parameters**

**Data Bits:** 5, 6, 7, 8  
**Stop Bits:** 1, 1.5, 2  
**Parity:** None, Even, Odd, Space, Mark  
**Flow Control:** RTS/CTS and DTR/DSR (RS-232 only), XON/XOFF  
**Baudrate:** 50 bps to 921.6 kbps

**Serial Signals**

**RS-232:** Tx+, Rx+, RTS, CTS, DTR, DSR, DCD, GND  
**RS-422:** Tx+, Tx-, Rx+, Rx-, GND  
**RS-485-4w:** Tx+, Tx-, Rx+, Rx-, GND  
**RS-485-2w:** Data+, Data-, GND

**Software**

**Network Protocols:** ICMP, IPv4, TCP, UDP, DHCP, BOOTP, Telnet, DNS, SNMP V1, HTTP, SMTP, IGMP V1/2, ARP  
**Configuration Options:** Web Console (with new Quick Setup), Serial Console (NPort 5110A/5150A only), Telnet Console, Windows Utility  
**Windows Real COM Drivers:** Windows 95/98/ME/NT/2000, Windows XP/2003/Vista/2008/7/8/8.1/10 (x86/x64), Windows 2008 R2/2012/2012 R2 (x64), Windows Embedded CE 5.0/6.0, Windows XP Embedded

**Fixed TTY Drivers:** SCO Unix, SCO OpenServer, UnixWare 7, QNX 4.25, QNX 6, Solaris 10, FreeBSD, AIX 5.x, HP-UX 11i, Mac OS X  
**Linux Real TTY Drivers:** Linux 2.4.x, 2.6.x, 3.x

**Physical Characteristics**

**Housing:** Metal  
**Weight:** 340 g (0.75 lb)  
**Dimensions:**  
 Without ears: 52 x 80 x 22 mm (2.05 x 3.15 x 0.87 in)  
 With ears: 75.2 x 80 x 22 mm (2.96 x 3.15 x 0.87 in)

**Environmental Limits**

**Operating Temperature:**  
 Standard Models: 0 to 60°C (32 to 140°F)  
 Wide Temp. Models: -40 to 75°C (-40 to 167°F)  
**Storage Temperature:** -40 to 75°C (-40 to 167°F)  
**Ambient Relative Humidity:** 5 to 95% (non-condensing)

**Power Requirements**

**Input Voltage:** 12 to 48 VDC  
**Input Current:**  
 NPort 5110A: 82.5 mA @ 12 VDC  
 NPort 5130A: 89.1 mA @ 12 VDC  
 NPort 5150A: 92.4 mA @ 12 VDC

**Standards and Certifications**

**Safety:** UL 60950-1  
**EMC:** EN 55022/24  
**EMI:** CISPR 22, FCC Part 15B Class A  
**EMS:**  
 IEC 61000-4-2 ESD: Contact: 6 kV; Air: 8 kV  
 IEC 61000-4-3 RS: 80 MHz to 1 GHz: 10 V/m  
 IEC 61000-4-4 EFT: Power: 2 kV; Signal: 1 kV  
 IEC 61000-4-5 Surge: Power: 2 kV; Signal: 0.5 kV  
 IEC 61000-4-6 CS: 150 kHz to 80 MHz: 10 V/m; Signal: 10 V/m  
 IEC 61000-4-8 PFMF  
 IEC 61000-4-11 DIPs

**Reliability**

**Automatic Reboot Trigger:** Built-in WDT (watchdog timer)

**MTBF** (mean time between failures)

Time: 2,231,530 hrs

Standard: Telcordia (Bellcore) Standard TR/SR

**Warranty**

Warranty Period: 5 years

Details: See [www.moxa.com/warranty](http://www.moxa.com/warranty)

**Dimensions**

Unit: mm (inch)

**NPort® 5110A**

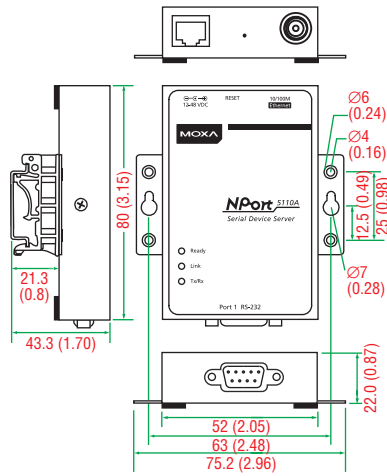

**NPort® 5130A**

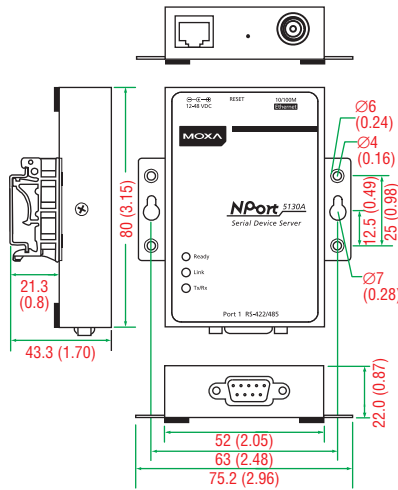

**NPort® 5150A**

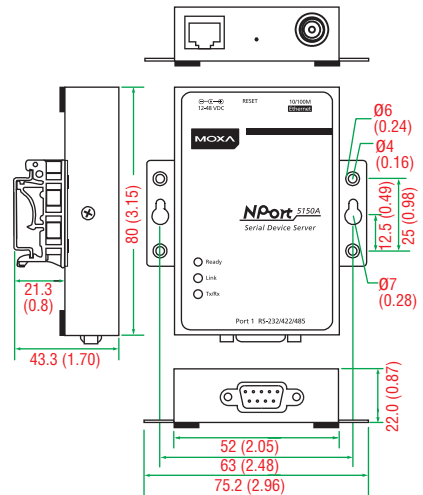

**Pin Assignment**

**DB9 male connector**

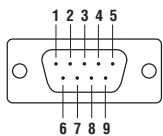

**NPort® 5110A (RS-232)**

PIN	RS-232
1	DCD
2	RxD
3	TxD
4	DTR
5	GND
6	DSR
7	RTS
8	CTS

**NPort® 5130A (RS-422/485)**

PIN	RS-422/485-4w	RS-485-2w
1	TxD-(A)	-
2	TxD+(B)	-
3	RxD+(B)	Data+(B)
4	RxD-(A)	Data-(A)
5	GND	GND
6	-	-
7	-	-
8	-	-

**NPort® 5150A (RS-232/422/485)**

PIN	RS-232	RS-422/485-4w	RS-485-2w
1	DCD	TxD-(A)	-
2	RxD	TxD+(B)	-
3	TxD	RxD+(B)	Data+(B)
4	DTR	RxD-(A)	Data-(A)
5	GND	GND	GND
6	DSR	-	-
7	RTS	-	-
8	CTS	-	-

**Ordering Information**

**Available Models**

**NPort 5110A:** 1-port RS-232 device server, 0 to 60°C operating temperature

**NPort 5130A:** 1-port RS-422/485 device server, 0 to 60°C operating temperature

**NPort 5150A:** 1-port RS-232/422/485 device server, 0 to 60°C operating temperature

**NPort 5110A-T:** 1-port RS-232 device server, -40 to 75°C operating temperature

**NPort 5130A-T:** 1-port RS-422/485 device server, -40 to 75°C operating temperature

**NPort 5150A-T:** 1-port RS-232/422/485 device server, -40 to 75°C operating temperature

**Optional Accessories** (can be purchased separately)

**DK35A:** DIN-rail mounting clips, 35 mm, 2 DIN-rail plates with 4 screws

**CBL-PJ21NOPEN-BK-30:** Locking barrel plug to bare-wires cable

**Mini DB9F-to-TB:** DB9 female to terminal block adapter for RS-422/485 applications





Note: One power adapter suitable for your region is included in the product package. Additional power adapters can be purchased separately. Please refer to the Power Accessory Selection Guide for details.

**Package Checklist**

- 1 NPort 5100A device server
- 100 to 240 VAC power adapter (excluding T models)\*
- Documentation and software CD
- Quick installation guide (printed)
- Warranty card





\*The package includes one power adapter suitable for your region.







# Power Accessory Selection Guide

Barrel Plug Type		Locking Barrel Plug				
O/P		12 VDC 0.5 A, 100 to 240 VAC (Switch-Mode)				
Plug Type		US/JP	EU	AU	UK	CN
Appearance						
Model Name		PWR-12050-WPUSJP-S1	PWR-12050-WPEU-S1	PWR-12050-WPAU-S1	PWR-12050-WPUK-S1	PWR-12050-WPCN-S1
1 Port	NPort 5110	-	-	-	-	-
	NPort 5130	-	-	-	-	-
	NPort 5150	-	-	-	-	-
	NPort 5110A	✓	✓	✓	✓	✓
	NPort 5130A	✓	✓	✓	✓	✓
	NPort 5150A	✓	✓	✓	✓	✓
	DE-211	-	-	-	-	-
	DE-311	-	-	-	-	-
	NPort P5150A	✓	✓	✓	✓	✓
	NPort W2150A	✓	✓	✓	✓	✓
NPort Z2150/Z3150	✓	✓	✓	✓	✓	
2 Ports	NPort 5210	-	-	-	-	-
	NPort 5230	-	-	-	-	-
	NPort 5232	-	-	-	-	-
	NPort 5232I	-	-	-	-	-
	NPort 5210A	✓	✓	✓	✓	✓
	NPort 5230A	✓	✓	✓	✓	✓
	NPort 5250A	✓	✓	✓	✓	✓
	NPort W2250A	✓	✓	✓	✓	✓

Barrel Plug Type		Non-Locking Barrel Plug				
O/P		12 VDC 0.5 A, 100 to 240 VAC (Switch-Mode)				
Plug Type		US/JP	EU	AU	UK	CN
Appearance						
Model Name		PWR-12050-WPUSJP-S2	PWR-12050-WPEU-S2	PWR-12050-WPAU-S2	PWR-12050-WPUK-S2	PWR-12050-WPCN-S2
1 Port	NPort 5110	✓	✓	✓	✓	✓
	NPort 5130	✓	✓	✓	✓	✓
	NPort 5150	✓	✓	✓	✓	✓
	NPort 5110A	-	-	-	-	-
	NPort 5130A	-	-	-	-	-
	NPort 5150A	-	-	-	-	-
	DE-211	✓	✓	✓	✓	✓
	DE-311	✓	✓	✓	✓	✓
	NPort P5150A	-	-	-	-	-
	NPort W2150A	-	-	-	-	-
NPort Z2150/Z3150	-	-	-	-	-	
2 Ports	NPort 5210	✓	✓	✓	✓	✓
	NPort 5230	✓	✓	✓	✓	✓
	NPort 5232	✓	✓	✓	✓	✓
	NPort 5232I	✓	✓	✓	✓	✓
	NPort 5210A	-	-	-	-	-
	NPort 5230A	-	-	-	-	-
	NPort 5250A	-	-	-	-	-
	NPort W2250A	-	-	-	-	-

# Power Accessory Selection Guide

Barrel Plug Type		Non-Locking Barrel Plug				
O/P		12 VDC 1.25/1.5 A, 100 to 240 VAC				
Plug Type		US/JP	EU	AU	UK	CN
Appearance						
Model Name		PWR-12125-USJP-S1	PWR-12150-EU-S2	PWR-12150-AU-S2	PWR-12150-UK-S2	PWR-12125-CN-S1
4 Ports	NPort 5410	✓	✓	✓	✓	✓
	NPort 5430	✓	✓	✓	✓	✓
	NPort 5430I	✓	✓	✓	✓	✓
	NPort 5450	✓	✓	✓	✓	✓
	NPort 5450I	✓	✓	✓	✓	✓
8 Ports	NPort 5610-8	-	-	-	-	-
	NPort 5630-8	-	-	-	-	-
	NPort 5650-8	-	-	-	-	-
	NPort 5650-8-M-SC	-	-	-	-	-
	NPort 5650-8-S-SC	-	-	-	-	-
	NPort 5610-8-DT	-	-	-	-	-
	NPort 5610-8-DT-J	-	-	-	-	-
	NPort 5650-8-DT	-	-	-	-	-
	NPort 5650-8-DT-J	-	-	-	-	-
	NPort 5650I-8-DT	-	-	-	-	-
	NPort 5610-8-DTL	-	-	-	-	-
NPort 5650-8-DTL	-	-	-	-	-	
NPort 5650I-8-DTL	-	-	-	-	-	
16 Ports	NPort 5610-16	-	-	-	-	-
	NPort 5630-16	-	-	-	-	-
	NPort 5650-16	-	-	-	-	-

Barrel Plug Type		Locking Barrel Plug						
O/P		12 VDC 2 A, 100 to 240 VAC (desktop type)	10A/250V Power Cord, 183 cm					
Plug Type		Must accompany with one power cord	US	JP	EU	AU	UK	CN
Appearance								
Model Name		PWR-12200-DT-S1	PWC-C13US-3B-183	PWC-C13JP-3B-183	PWC-C13EU-3B-183	PWC-C13AU-3B-183	PWC-C13UK-3B-183	PWC-C13CN-3B-183
4 Ports	NPort 5410	-	-	-	-	-	-	-
	NPort 5430	-	-	-	-	-	-	-
	NPort 5430I	-	-	-	-	-	-	-
	NPort 5450	-	-	-	-	-	-	-
	NPort 5450I	-	-	-	-	-	-	-
8 Ports	NPort 5610-8	-	✓	✓	✓	✓	✓	✓
	NPort 5630-8	-	✓	✓	✓	✓	✓	✓
	NPort 5650-8	-	✓	✓	✓	✓	✓	✓
	NPort 5650-8-M-SC	-	✓	✓	✓	✓	✓	✓
	NPort 5650-8-S-SC	-	✓	✓	✓	✓	✓	✓
	NPort 5610-8-DT	✓	✓	✓	✓	✓	✓	✓
	NPort 5610-8-DT-J	✓	✓	✓	✓	✓	✓	✓
	NPort 5650-8-DT	✓	✓	✓	✓	✓	✓	✓
	NPort 5650-8-DT-J	✓	✓	✓	✓	✓	✓	✓
	NPort 5650I-8-DT	✓	✓	✓	✓	✓	✓	✓
	NPort 5610-8-DTL	✓	✓	✓	✓	✓	✓	✓
NPort 5650-8-DTL	✓	✓	✓	✓	✓	✓	✓	
NPort 5650I-8-DTL	✓	✓	✓	✓	✓	✓	✓	
16 Ports	NPort 5610-16	-	✓	✓	✓	✓	✓	✓
	NPort 5630-16	-	✓	✓	✓	✓	✓	✓
	NPort 5650-16	-	✓	✓	✓	✓	✓	✓