

CN2510 Async Server User's Manual

Fifth Edition, August 2015

www.moxa.com/product



© 2015 Moxa Inc., all rights reserved.
Reproduction without permission is prohibited.

CN2510 Async Server User's Manual

The software described in this manual is furnished under a license agreement and may be used only in accordance with the terms of that agreement.

Copyright Notice

Copyright © 2015 Moxa Inc.
All rights reserved.
Reproduction without permission is prohibited.

Trademarks

MOXA is a registered trademark of Moxa Inc.
All other trademarks or registered marks in this manual belong to their respective manufacturers.

Disclaimer

Information in this document is subject to change without notice and does not represent a commitment on the part of Moxa.

Moxa provides this document “as is,” without warranty of any kind, either expressed or implied, including, but not limited to, its particular purpose. Moxa reserves the right to make improvements and/or changes to this manual, or to the products and/or the programs described in this manual, at any time.

Information provided in this manual is intended to be accurate and reliable. However, Moxa assumes no responsibility for its use, or for any infringements on the rights of third parties that may result from its use.

This product might include unintentional technical or typographical errors. Changes are periodically made to the information herein to correct such errors, and these changes are incorporated into new editions of the publication.

Technical Support Contact Information

www.moxa.com/support

Moxa Americas:

Toll-free: 1-888-669-2872
Tel: +1-714-528-6777
Fax: +1-714-528-6778

Moxa China (Shanghai office):

Toll-free: 800-820-5036
Tel: +86-21-5258-9955
Fax: +86-10-6872-3958

Moxa Europe:

Tel: +49-89-3 70 03 99-0
Fax: +49-89-3 70 03 99-99

Moxa Asia-Pacific:

Tel: +886-2-8919-1230
Fax: +886-2-8919-1231

Table of Contents

Chapter 1	Introduction.....	1-1
	Product Features	1-2
	Hardware.....	1-2
	Software	1-2
	Package Checklist	1-2
	Front Panel	1-3
	Rear Panel.....	1-3
	Bottom Label.....	1-3
Chapter 2	Getting Started.....	2-1
	Hardware Installation	2-2
	Desktop	2-2
	Rackmount	2-2
	Wiring Requirements	2-3
	Connecting CN2510-8/16's Power	2-3
	Connecting CN2510-8/16-48V's Power	2-3
	Grounding CN2510-8/16-48V	2-4
	Connecting to the Network	2-4
	Connecting to a Serial Device.....	2-4
	Connecting to the Console Port.....	2-4
	Accessing the Console Utility	2-4
	Configuration Checklist	2-5
	Accessing the Console from a Telnet Terminal	2-5
	Accessing the Console from a Console Terminal	2-7
	Configuring CN2510—The Server Menu.....	2-13
	Server Configuration—Info.....	2-13
	Server Configuration—LAN.....	2-14
	Server Configuration—Adv.....	2-15
	Server Configuration—Host_table.....	2-17
	Server Configuration—Route_table.....	2-18
	Server Configuration—User_table.....	2-18
	Save.....	2-19
	Restart	2-20
Chapter 3	Knowing Your Application.....	3-1
	Windows Real COM (NT Real COM)	3-2
	Linux Real TTY/Unix Fixed TTY (NT Real COM)	3-3
	Device Control (Device Control)	3-3
	UDP Communication (Raw UDP).....	3-4
	Console Management (Reverse Terminal)	3-5
	Terminal Access (Terminal).....	3-6
	Multi-host TTY (Multi-host TTY).....	3-7
	Dial-in/Out-of-Band Management (Dialin/out)	3-8
	Network Printer (Printer)	3-9
	Multiplexor Access (Multiplex)	3-10
Chapter 4	Setting Up Windows Real COM/Linux Real TTY/Unix Fixed TTY	4-1
	Accessing the Console Utility	4-2
	Selecting the Application.....	4-3

	Configuring ASPP Mode	4-4
	Configuring the Serial Ports	4-5
	Save	4-6
	Restart	4-7
	Setting up Hosts	4-7
	Setting up Windows XP/2003 Hosts	4-7
	Setting up Windows 2000 Hosts	4-23
	Setting up Windows 95/98/ME/NT Hosts	4-37
Chapter 5	Setting Up Device Control	5-1
	Accessing the Console Utility	5-2
	Selecting the Application.....	5-3
	Configuring ASPP Mode	5-4
	Configuring RAW Mode	5-6
	Configuring the Serial Ports.....	5-8
	Save	5-9
	Restart	5-9
	ASPP Library Introduction	5-10
	ASPP Examples for Unix	5-10
	ASPP Examples for Windows.....	5-11
Chapter 6	Setting Up Raw UDP.....	6-1
	Accessing the Console Utility	6-2
	Selecting the Application.....	6-3
	Configuring RAW UDP Mode	6-4
	Configuring the Serial Ports.....	6-6
	Save.....	6-7
	Restart	6-8
Chapter 7	Setting Up Reverse Terminal.....	7-1
	Accessing the Console Utility	7-2
	Selecting the Application.....	7-3
	Configuring RTELNET Mode	7-4
	Configuring the Serial Ports.....	7-5
	Save.....	7-7
	Restart	7-7
Chapter 8	Setting Up Terminal.....	8-1
	Accessing the Console Utility	8-2
	Selecting the Application.....	8-3
	Configuring TERM_ASC Mode.....	8-4
	Configuring TERM_BIN Mode	8-7
	Configuring the Serial Ports.....	8-9
	Save.....	8-10
	Restart	8-11
Chapter 9	Setting Up Multi-host TTY.....	9-1
	Accessing the Console Utility	9-2
	Selecting the Application.....	9-3
	Configuring FIXTTY Mode	9-4
	Configuring the Serial Ports.....	9-5
	Save.....	9-6
	Restart	9-7

	Setting up Hosts	9-7
	Installing and Compiling Moxatty	9-7
	Moxatty for Different Applications.....	9-9
	Using Moxatty	9-10
Chapter 10	Setting Up Dialin/out	10-1
	Accessing the Console Utility	10-2
	Selecting the Application.....	10-3
	Configuring PPPD/PPP Mode	10-4
	Configuring SLIPD/SLIP Mode	10-6
	Configuring Dynamic Mode	10-8
	Configuring the Serial Ports.....	10-13
	Configuring Modem Initialization	10-14
	Optional Welcome Message.....	10-15
	Configuring Optional Local User Information.....	10-15
	Save.....	10-16
	Restart	10-17
Chapter 11	Setting Up Printer	11-1
	Accessing the Console Utility	11-2
	Selecting the Application.....	11-3
	Configuring RAW PRN Mode	11-4
	Configuring LPD PRN Mode.....	11-6
	Configuring the Serial Ports.....	11-7
	Save.....	11-8
	Restart	11-9
	Setting up Unix Hosts	11-9
	Setting up a SCO Unix Host	11-9
	Setting up a SOLARIS X86 Host.....	11-10
	Setting up a LINUX Host.....	11-11
	Setting up Windows Hosts.....	11-12
	Setting up a Windows NT Host	11-12
	Setting up a Windows 2000 Host.....	11-16
Chapter 12	Setting Up Multiplex	12-1
	Accessing the Console Utility	12-2
	Selecting the Application.....	12-3
	Configuring the "Host" CN2510	12-3
	Configuring the "Device" CN2510.....	12-7
	Configuring the Serial Ports.....	12-11
	Save.....	12-12
	Restart	12-13
Chapter 13	Setting Up Routing	13-1
	Accessing the Console Utility	13-2
	What is RIP?.....	13-3
	Configuring RIP	13-3
	Configuring the Static Routing Table	13-4
	Static Routing Examples.....	13-5
	Configuring Routes to the Internet.....	13-5
	Configuring Routes to the Internet and Intranet.....	13-6
	Configuring Multiple-Point Routes.....	13-7
	Save.....	13-8

	Restart	13-8
Chapter 14	Administrative Utilities.....	14-1
	Ping.....	14-2
	Monitor	14-2
	Line	14-3
	Network	14-4
	Async	14-5
	Routing.....	14-6
	PPP-Trace	14-6
	Diagnostic	14-7
	Upgrade	14-8
	Upgrading with the Windows Utility	14-8
	Console Terminal Upgrade	14-9
	Upgrading through the Serial Console	14-11
	Remote RCP Upgrade.....	14-14
	Export.....	14-16
	Console Terminal Export	14-16
	Remote RCP Export.....	14-19
	Import.....	14-19
	Console Terminal Import	14-19
	Remote RCP Import.....	14-22
	Default.....	14-22
Appendix A	Troubleshooting	A-1
	Console Terminal Problems.....	A-2
	Terminal Port Problems	A-4
	How to Save CN2510's Parameters	A-5
	ASPP Port Problems	A-5
	SLIP/PPP Connection Problems	A-6
	RADIUS Problems	A-6
Appendix B	RADIUS Server.....	B-1
	What is RADIUS?	B-2
	Definition	B-2
	Client/Server Architecture	B-2
	Setting up CN2510	B-2
	Setting up the RADIUS Server IP Address.....	B-2
	Setting up Port Configuration	B-3
	Setting up UNIX Hosts.....	B-5
	Setting up Windows NT Hosts	B-6
	Setting up Windows 2000 Hosts.....	B-8
	Setting up Windows 2003 Hosts.....	B-11
Appendix C	SNMP Agent with MIB II	C-1
Appendix D	Pin Assignments and Cable Wiring	D-1
	Pin Assignments	D-2
	10/100BaseTX Port Pin Assignment	D-2
	Console Port Pin Assignment.....	D-2
	Async RS-232 Port Pin Assignment	D-2
	Cable Wiring	D-2
	10/100BaseTX Port Cable Wiring	D-2

	Async RS-232 Port Cable Wiring	D-3
	DB9 and DB25 Connector Pin Assignments	D-4
Appendix E	LCM Display	E-1

Welcome to Moxa CN2510 Async Server. Models are available with 8 or 16 asynchronous RS-232 ports, and all models come with one 10/100 Mbps Ethernet LAN port. CN2510 Async Server is used to connect terminals, modems, printers, and other asynchronous serial devices to LAN hosts. CN2510 complies with TCP/IP and IEEE 802.3 specifications using standard Ethernet 10/100BaseT and twisted pair 10/100BaseTX cable as the data transmission medium.

The following topics are covered in this chapter:

- Product Features**
 - Hardware
 - Software
- Package Checklist**
- Front Panel**
- Rear Panel**
- Bottom Label**

Product Features

Hardware

- 1 LAN port (auto-detecting 10/100 Mbps Ethernet)
- Surge protection for each serial port
- 4 MB RAM, 2 MB Flash ROM
- Tx/Rx LED for each serial port
- System Status LEDs
- Ethernet Status LEDs
- 8 or 16 RJ45 RS-232 serial ports, with up to 921.6 Kbps transmission speed

Software

- ASCII/Binary terminal modes with up to 8 Telnet and Rlogin sessions
- Point to Point Protocol (PPP and PPPD)
- Serial Line Internet Protocols (SLIP and SLIPD)
- Dynamic auto-recognition of Terminal, SLIP, or PPP
- Dial-on-demand, Dial-out
- Remote serial or parallel printing (RLP)
- CN2510 Async Server Proprietary Protocol (ASPP) for TCP/IP socket programming
- RAW mode for transparent data transmission
- Reverse Telnet
- SNMP Agent for network management
- Network protocols: TCP/IP, UDP, ICMP, NetBEUI, DHCP
- Application protocols: Telnet, Rlogin, Rtelnet, RAW TCP, RAW UDP, RCP, WINS, LPD, DNS, Multi-Host
- Security protocols: RADIUS, Dial-back, PAP, CHAP, Local user/password
- Real COM port driver for Windows 95/98/ME/NT/2000/XP/2003
- Fixed TTY: SCO Open Server5, SCO UnixWare 7, Linux 2.2.x, Linux 2.4.x
- Static Routing, RIP I/II protocols
- Windows-like administrative CONSOLE utility from a fixed console port, or by Telnet from a networked host
- Password protection and extensive user verification functions
- Easy firmware upgrade via Flash ROM

Package Checklist

CN2510 Async Server products are shipped with the following items:

- CN2510 Async Server
- AC power Cord (for AC Model only)
- Documentation and Software CD-ROM
- Quick Installation Guide (English and Simplified Chinese versions)
- RJ45 Loopback Tester
- Product Warranty Booklet
- Rackmount Kit (includes 2 brackets and 8 screws)
- Desktop Kit (includes 4 pads)

Front Panel

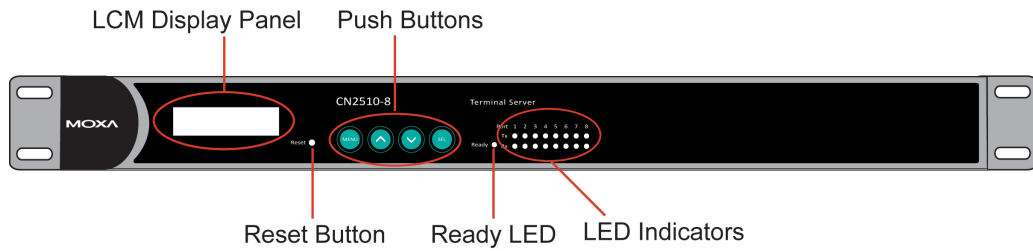

Feature	Description	
Reset Button	Press the Reset button for 5 seconds to load factory defaults. CN2510 will beep twice when the configuration has been reset.	
Push Buttons	Used for configuring the IP address and other parameters.	
Ready LED	Red	Indicates that CN2510 is receiving power
	Green	Indicates that CN2510's OS is ready
Serial Tx	Green	Indicates serial port transmission
Serial Rx	Yellow	Indicates serial port reception

Rear Panel

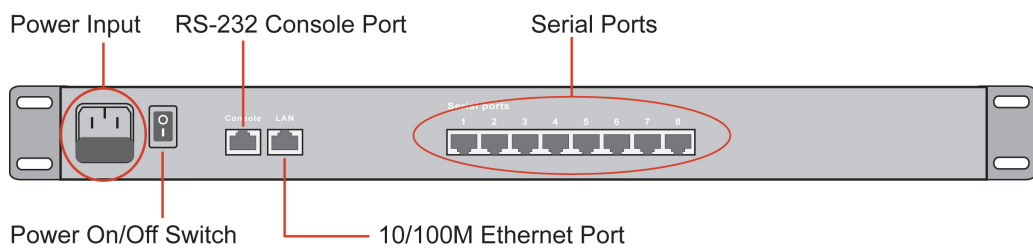

Socket / Port	Description
AC Power Input	CN2510-8 and CN2510-8: Automatic detection of 100-240V, 47-63 Hz AC power supply
DC Power Input	CN2510-8-48V and CN2510-8-48V: Automatic detection of 48 VDC or -48 VDC power supply
Power On/Off Switch	I indicates power on; O indicates power off (AC models only)
Console	8-pin RJ45 RS-232 port for console terminal connection
LAN	8-pin RJ45 auto-detectable 10/100 Mbps UTP port
Serial Ports	8 or 16 8-pin RJ45 ports for DCE modem-type connections

Bottom Label

The server's serial number and MAC address are printed on a label fixed to the bottom of the server. CN2510 has 1 Ethernet port, which has a corresponding MAC address. The MAC address is the unique hardware Ethernet address used to identify a network hardware product. Write the number here for later reference.

LAN 1 MAC address: _____

2

Getting Started

This chapter includes instructions on where and how to install CN2510 Async Server. Both basic and advanced software configuration instructions are given.

The following topics are covered in this chapter:

- ❑ **Hardware Installation**
 - Desktop
 - Rackmount
 - Wiring Requirements
 - Connecting CN2510-8/16's Power
 - Connecting CN2510-8/16-48V's Power
 - Grounding CN2510-8/16-48V
 - Connecting to the Network
 - Connecting to a Serial Device
 - Connecting to the Console Port
- ❑ **Accessing the Console Utility**
 - Configuration Checklist
 - Accessing the Console from a Telnet Terminal
 - Accessing the Console from a Console Terminal
- ❑ **Configuring CN2510—The Server Menu**
 - Server Configuration—Info.
 - Server Configuration—LAN
 - Server Configuration—Adv
 - Server Configuration—Host_table
 - Server Configuration—Route_table
 - Server Configuration—User_table
- ❑ **Save**
- ❑ **Restart**

Hardware Installation

Desktop

Place your CN2510 on a clean, flat, well-ventilated desktop. For better ventilation, attach the 4 pads from the desktop kit to the bottom of the unit, and leave some space between the CN2510 and other equipment. Do not place equipment or objects on top of the unit, as this might damage the server.

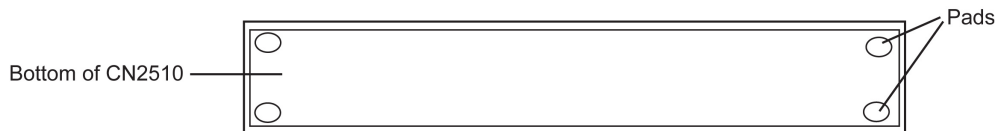

Rackmount

CN2510 is designed to be mounted on a standard 19-inch rack. Use the enclosed pair of L-shaped metal brackets and screws to fasten your CN2510 to the rack cabinet. Each L-shaped bracket has 6 holes, leaving two outer or inner holes available for other uses. You have two options. You can lock either the front or rear panel of the CN2510 to the front of the rack. Locking the front panel is shown in the following figure.

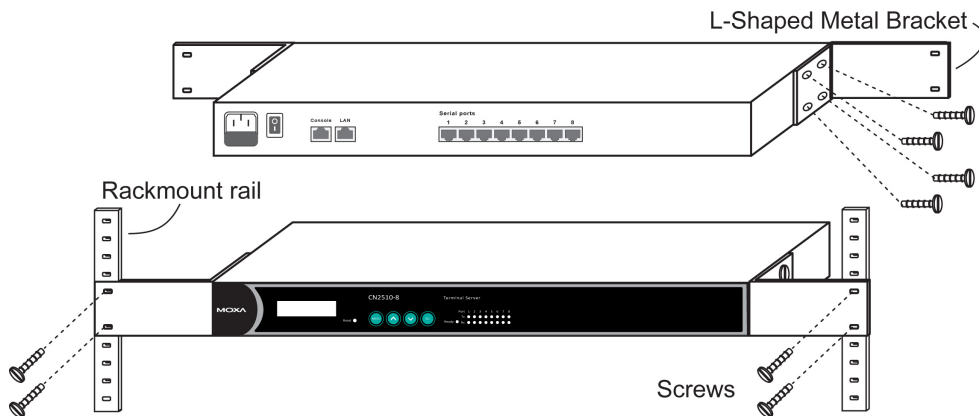

Wiring Requirements



ATTENTION

Safety First!

Be sure to disconnect the power cord before installing and/or wiring your CN2510.

Wiring Caution!

Calculate the maximum possible current in each power wire and common wire. Observe all electrical codes dictating the maximum current allowable for each wire size.

If the current goes above the maximum ratings, the wiring could overheat, causing serious damage to your equipment.

Temperature Caution!

Be careful when handling CN2510. When plugged in, CN2510's internal components generate heat, and consequently the board may feel hot to the touch.

You should also observe the following common wiring rules:

- Use separate paths to route wiring for power and devices. If power wiring and device wiring paths must cross, make sure the wires are perpendicular at the intersection point.
NOTE: Do not run signal or communication wiring and power wiring in the same wire conduit. To avoid interference, wires with different signal characteristics should be routed separately.
- You can use the type of signal transmitted through a wire to determine which wires should be kept separate. The rule of thumb is that wiring that shares similar electrical characteristics can be bundled together.
- Keep input wiring and output wiring separate.
- Where necessary, it is strongly advised that you label wiring to all devices in the system.

Connecting CN2510-8/16's Power

Connect CN2510's 100-240 VAC power line to its AC connector. If the power is properly supplied, the "Ready" LED will show a solid red color until the system is ready, at which time the color changes to green.

Connecting CN2510-8/16-48V's Power

To connect CN2510-8/16-48V's power cord to its terminal block, follow the steps given below:

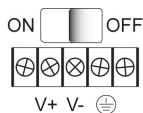

1. Loosen the screws on the V+ and V- terminals of CN2510-8/16-48V's terminal block.
2. Connect the power cord's 48 VDC or -48 VDC wire to the terminal block's V+ terminal, and the power cord's DC Power Ground wire to the terminal block's V- terminal, and then tighten the terminal block screws.
(Note: CN2510-8/16-48V will still operate properly if the 48V/-48V and DC Power Ground wires are reversed.)

If the power is properly supplied, the "Ready" LED will show a solid red color until the system is ready, at which time the color changes to green.

NOTE Use 8 kg-cm of screw torque and 22-14 AWG electric wire to connect CN2510-8/16-48V's power cord to its terminal block.

Grounding CN2510-8/16-48V

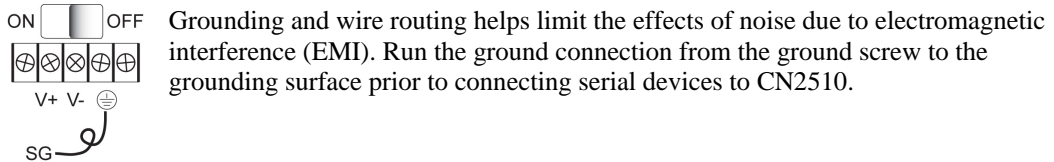

The Shielded Ground (sometimes called Protected Ground) contact is the second contact from the right of the 5-pin power terminal block connector located on the rear panel of CN2510-8/16-48V. Connect the SG wire to the Earth ground.



ATTENTION

CN2510-8/16-48V should be mounted to a well-grounded surface, such as a metal panel.

Connecting to the Network

Connect one end of the Ethernet cable to CN2510's 10/100M Ethernet port and the other end of the cable to the Ethernet network. There are 2 LED indicators located on the top left and right corners of the Ethernet connector. If the cable is properly connected, CN2510 will indicate a valid connection to the Ethernet in the following ways:

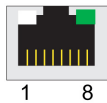

The top right corner LED indicator maintains a solid green color when the cable is properly connected to a 100 Mbps Ethernet network.

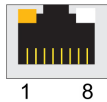

The top left corner LED indicator maintains a solid orange color when the cable is properly connected to a 10 Mbps Ethernet network.

Connecting to a Serial Device

Use appropriately wired serial data cables to connect serial devices to CN2510's serial ports.

Connecting to the Console Port

A console is a combination of keyboard and monitor that is used to configure settings and monitor the status of your system. The console port can be used if a network is unavailable, or you do not know CN2510's IP address. To connect to the console port, use a PC running UNIX, or a PC with terminal emulation software (e.g., HyperTerminal or PCComm by Moxa; parameter settings are: baud rate = 115200 bps, parity check = None, data bits = 8, stop bits = 1, terminal type = VT100). Use an RJ45-to-DB25 or RJ45-to-DB9 cable to connect the terminal to the console port.

Accessing the Console Utility

The Console Utility is the main application used to set up the server, configure the ports, and run utilities (ping, diagnosis, monitor, and upgrade). There are two ways to access the Console Utility—with terminal emulation from a console terminal, or with Telnet from a network terminal.

NOTE If your network is already set up, telnet over the network to CN2510's IP address to access the Console Utility. If your network environment is not set up, use Moxa PComm Terminal to establish a direct serial console connection.

Configuration Checklist

You will need the following information to configure CN2510. Check with your network administrator if you do not know all of the required information.

Basic CN2510 Information:

Name	
Location	
LAN1 IP address	
LAN1 IP netmask	
LAN1 default gateway IP address	
Domain server 1 IP address	
Domain server 2 IP address	
WINS server IP address	
Console password	

Accessing the Console from a Telnet Terminal

Connect CN2510 to your LAN and then turn on the power. Use the Moxa Windows Utility to find CN2510's IP address, and then telnet to the IP address to enter the CN2510 console.

CN2510 Windows Utility

The CN2510 Utility is a convenient Windows utility that can be used to find both the name and IP address of your CN2510. Once you know the IP address, you can telnet CN2510 over the network to complete the configuration process and to gather information about all servers on the network.

1. Run **upgrade.exe**, located in the \Software\Firmware\ folder on the CN2510 Documentation and Software CD, or run **NPort Tool** → **Firmware Utility** from the Start menu.



2. The CN2510 Utility will search for all CN2510s on the network.

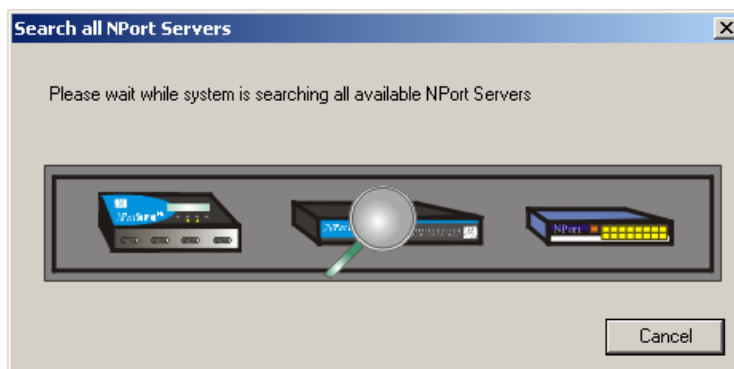

- The CN2510 Utility lists all available servers on the network. Note that servers in grey are password protected. Double click the server's name, or click on  from the menu bar to see the server settings.

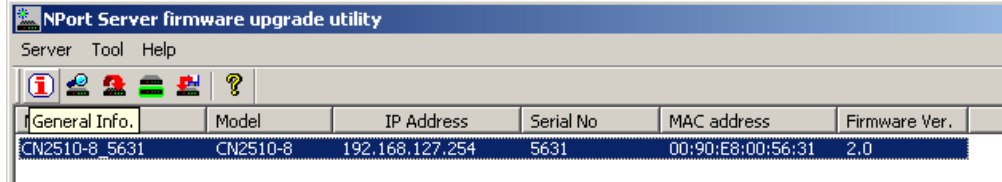

- The server's general information is shown in the **NPort Server General Info.** window. If necessary, change the settings, and then click on **OK** to accept the change.

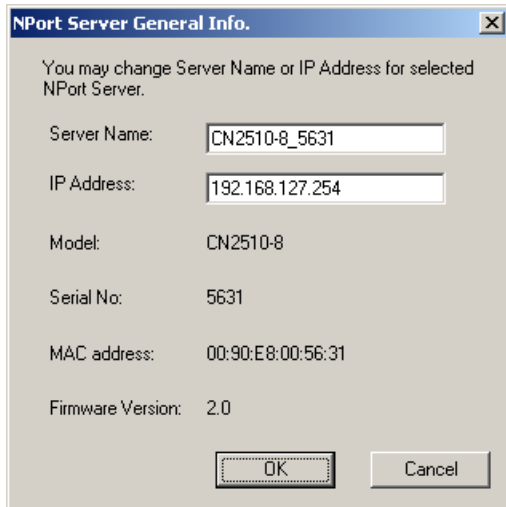

- If you can't find the server in the list, double-check the server's power and network connections, and then use search  to try locating the server again.

Using Telnet

- Telnet over the network to the server's IP address.

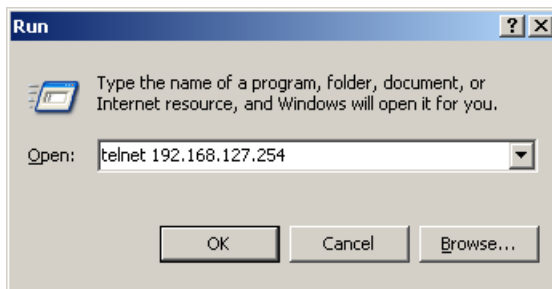

- Type **1** to choose **ansi/vt100**, and then press **Enter**.

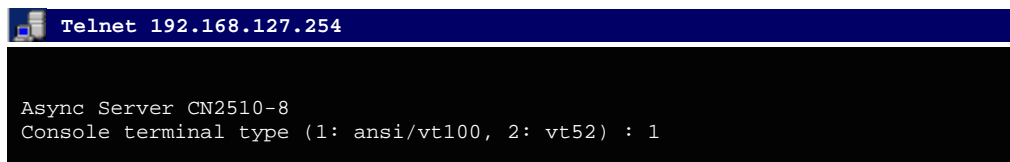

- CN2510's **MAIN MENU** will open, as shown below.

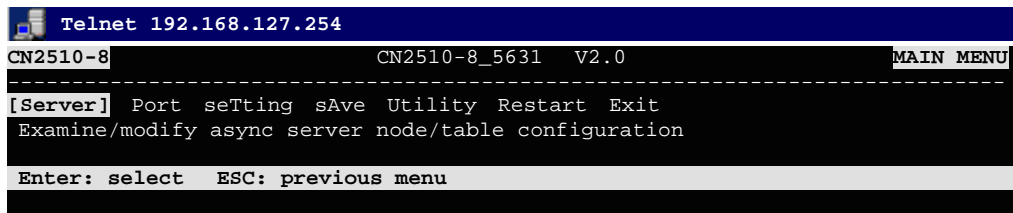

Use the following keystrokes to navigate CN2510's console utility.

Action	Key
Move	[Up/Down/Left/Right] Arrow Key or [Tab] Key
Jump to next menu, or Select item	[Enter] Key
Return to previous menu, or Close pop up selector	[Esc] Key
Shortcut Key	Capitalized letter of the word

Accessing the Console from a Console Terminal

If you do not know the CN2510's IP address, or it is not possible to use Telnet, you can use a direct console connection to enter the CN2510 console. Use a terminal emulation program for the console PC, such as HyperTerminal or Moxa PComm Terminal Emulator.

- If you are using Windows 9x/ME/NT, run **PComm26.exe** from the Win9xNT directory. If you are using Windows 2000/XP/2003, run **PComm2K.exe**, as shown in the figure below, from the Win2kXP2003 directory.

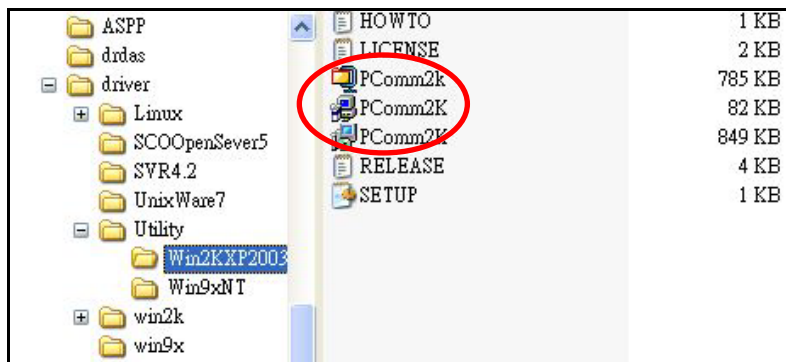

2. Click on **Next** to Continue.

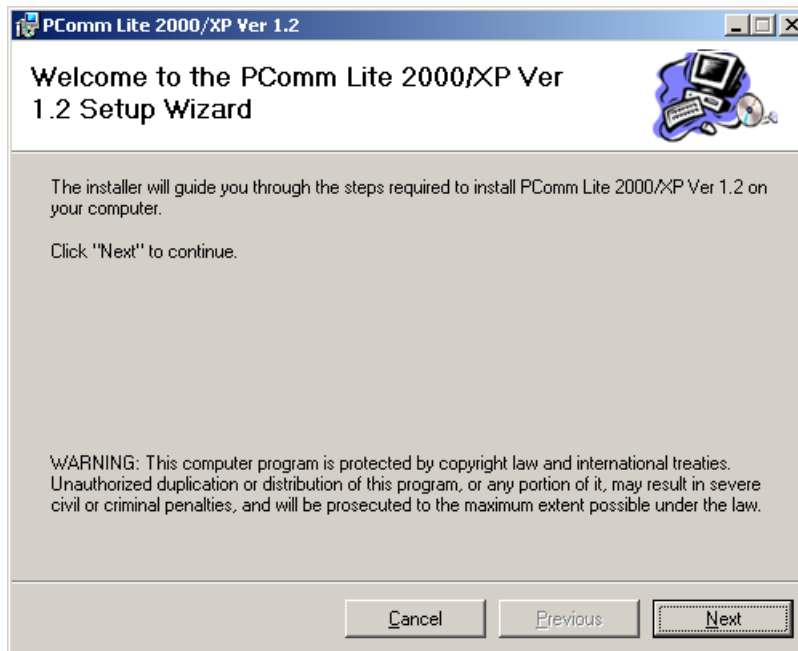

3. Select the **I Agree** option and then click on **Next**.

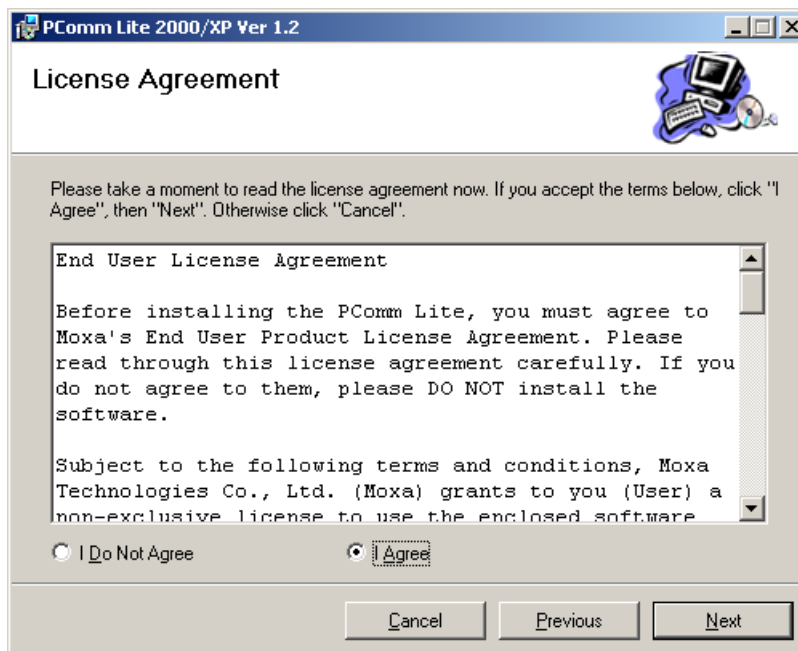

4. Select a directory in which to install the CN2510 Utility, and then click on **Next**.

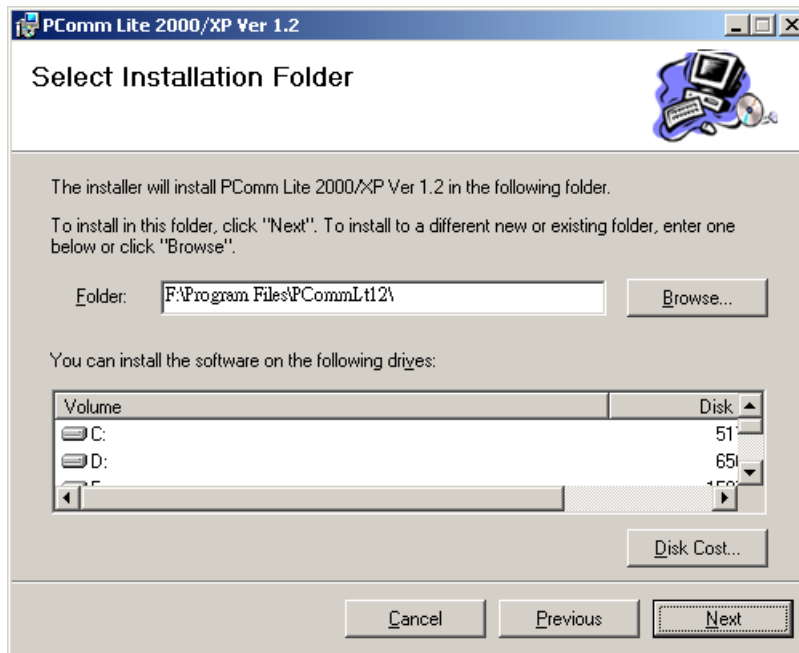

5. Click on **Next** to continue.

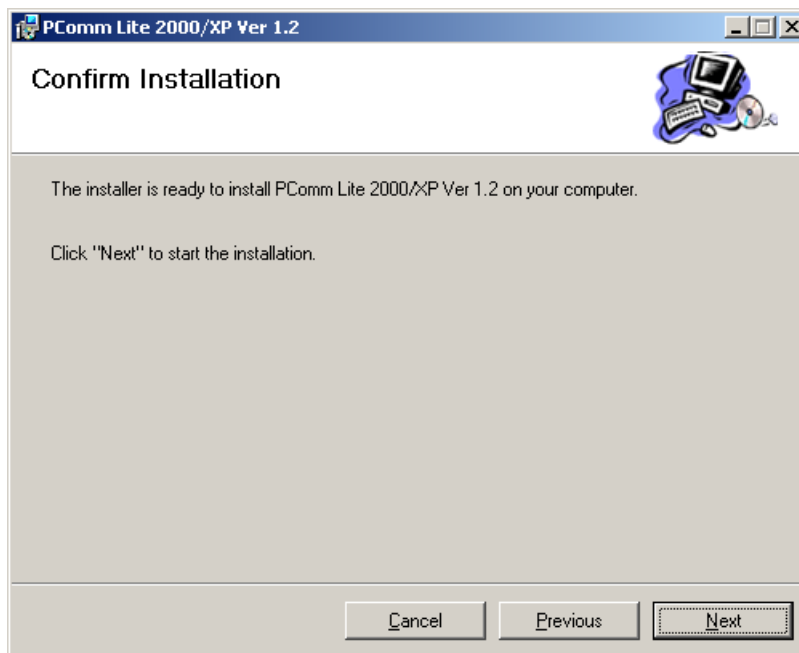

6. Wait while the PComm Lite software is installed.

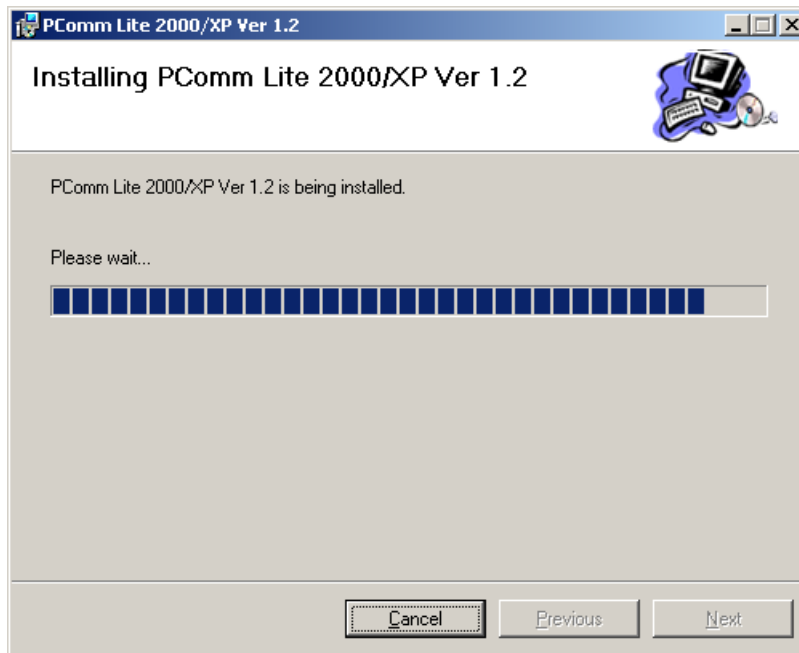

7. Click on **Close**.

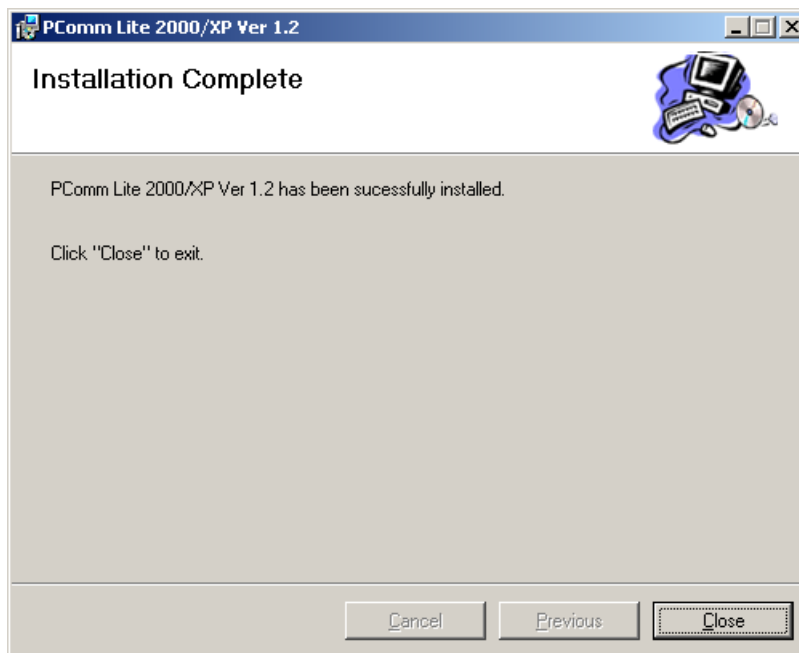

- 8. When the installation is complete, select **Start → Programs → PComm Terminal Emulator** to run PComm Terminal Emulator.

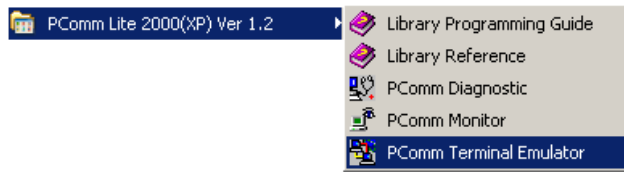

- 9. Use an RJ45 to DB25 female cable to connect to the CN2510 console port. Start PComm Terminal, and then click on the left-most icon to open a new connection.

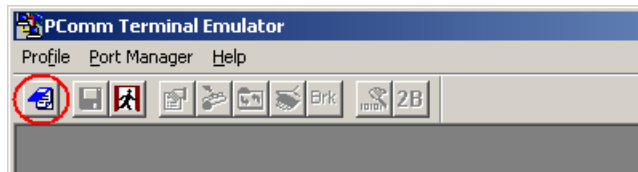

- 10. Click on the **Communication Parameter** tab, select the COM port (**COM2** in this example) for console connection, **115200** for Baud Rate, **8** for Data Bits, **None** for Parity, and **1** for Stop Bits.

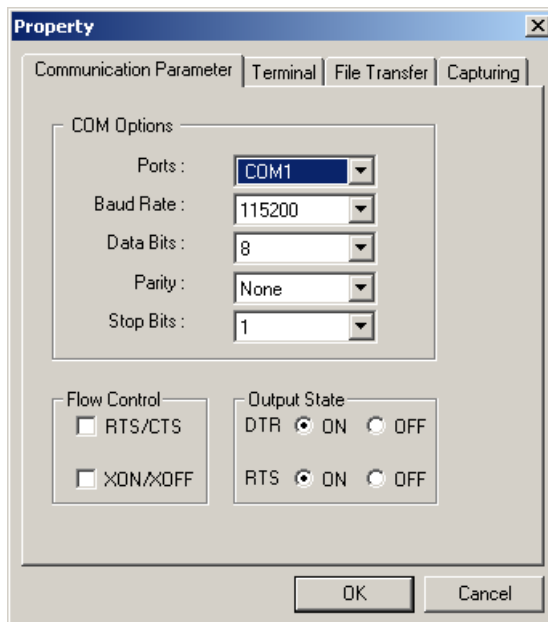

- Click on the **Terminal** tab and select **VT100** for terminal type. Press **Enter** to confirm.

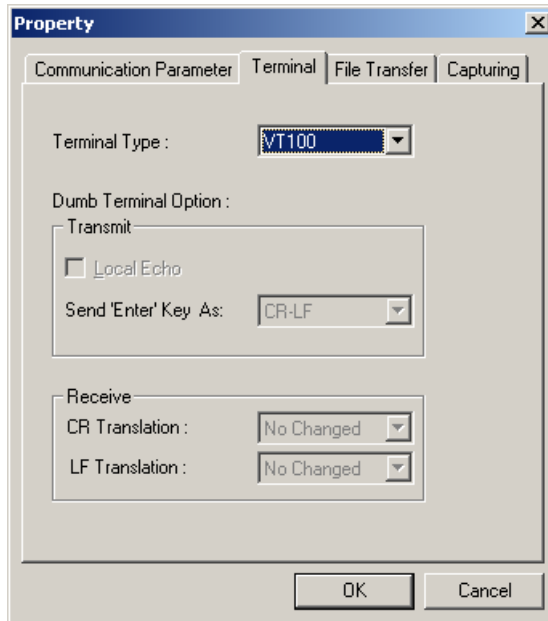

- Type 1 to select **ansi/VT100** terminal type, and then press **Enter** to open the **MAIN MENU**.

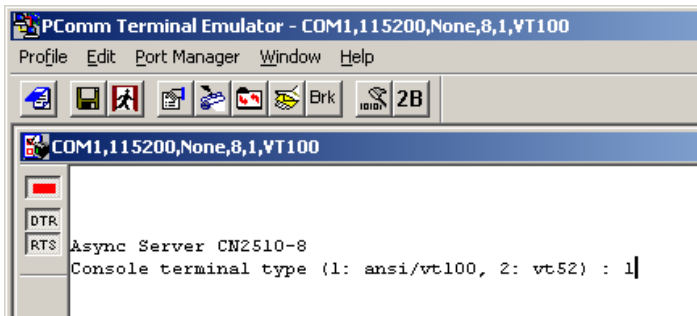

- The **MAIN MENU** is shown below. (NOTE: Click on **Edit** → **Font** to choose a different font for the **MAIN MENU**.)

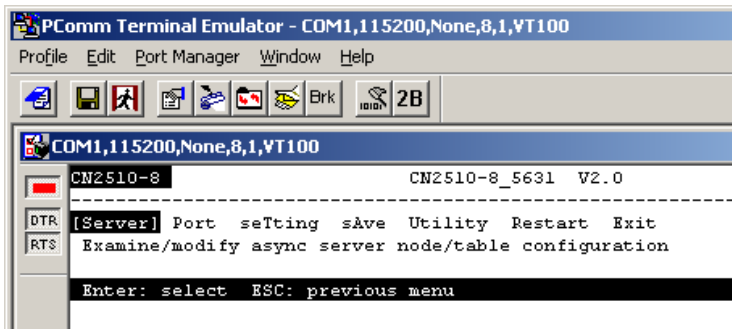

Configuring CN2510—The Server Menu

In this section, we describe both basic and advanced configuration tasks. We use the Telnet interface to illustrate (the Serial Console interface is the same).

Server Configuration—Info.

1. From the **MAIN MENU**, use the arrow keys to select **Server**, and then press **Enter**.

```

CN2510-8                               CN2510-8_5631  V2.0                               MAIN MENU
-----
[Server] Port seTting sAve Utility Restart Exit
Examine/modify async server node/table configuration

Enter: select  ESC: previous menu

```

2. From the **SERVER MENU**, select **Info.**, and then press **Enter**.

```

CN2510-8                               CN2510-8_5631  V2.0                               SERVER MENU
-----
[Info.] Lan Adv. Host_table Route_table User_table Quit
Examine/modify async server basic configuration

Enter: select  ESC: previous menu

```

3. The **Info.** page contains input/display fields for **name**, **location**, **serial number**, **Domain server 1/2 IP address**, **WINS function disable**, **WINS server IP address**, and **Console password**. Each item is described in detail below.

```

CN2510-8                               CN2510-8_5631  V2.0
-----
[Info.] Lan Adv. Host_table Route_table User_table Quit
Examine/modify async server basic configuration

ESC: back to menu  Enter: select

Async server name          [CN2510-8_5631          ]
Async server location      [                      ]
Async server serial number [9]

Domain server 1 IP address [                      ]
Domain server 2 IP address [                      ]
WINS function disable     [no ]
WINS server IP address    [                      ]

Console password          [                      ]

```

Async server name—CN2510 uses this name to identify itself when requested by an SNMP station or UNIX host. Use an ASCII string with maximum length of 40 characters for the name. Spaces are allowed.

Async server location—CN2510 reports this location to the SNMP station when requested. Use an ASCII string with maximum length of 44 characters for the location. Spaces are allowed.

Async server serial number—Each CN2510 Async Server is assigned a unique serial number before it leaves the factory. The serial number cannot be changed.

Domain server 1/2 IP address—A Domain Name Server is a network host that translates host names to IP addresses. Hosts use the Domain Name Server to request the IP address that corresponds to a particular url (such as www.moxa.com). Input the IP address of the primary Domain Name Server in the **Domain server 1 IP address** field, and the IP address of the

secondary Domain Name Server in the **Domain server 2 IP address** field. When CN2510 receives a connection request, CN2510 first checks the host table defined on the `Host_table` page. If a matching entry cannot be found, CN2510 sends a query to the Domain Name Server.

WINS function disable—Enable or disable the WINS server. The default setting is “enable.”

WINS server IP address—If a WINS Server is connected to the network, use this field to record the WINS Server’s IP address. TCP/IP uses IP addresses to identify hosts, but users often use symbolic names, such as computer names. The WINS (Windows Internet Naming Service) Server, which uses NetBIOS over TCP/IP, contains a dynamic database to map computer names to IP addresses.

Console password—If you specify a password, write it down for safe keeping. If you forget the password, you will need to use the reset password button to reset it. Only use the console password when absolutely necessary.

NOTE Write your console password in a safe place before setting the password.

Server Configuration—LAN

1. From the **MAIN MENU**, use the arrow keys to select **Server**, and then press **Enter**.

```

CN2510-8                               CN2510-8_5631  V2.0                               MAIN MENU
-----
[Server] Port seTting sAve Utility Restart Exit
Examine/modify async server node/table configuration

Enter: select  ESC: previous menu
    
```

2. From the **SERVER MENU**, select **Lan**, and then press **Enter**.

```

CN2510-8                               CN2510-8_5631  V2.0                               SERVER MENU
-----
Info. [Lan] Adv. Host_table Route_table User_table Quit
Examine/modify async server basic configuration

Enter: select  ESC: previous menu
    
```

3. The **Lan** page contains input/display fields for **DHCP (client)**, **Async server IP address**, **Async server IP netmask**, **Default gateway IP address**, **Ethernet speed**, and **Ethernet address**. Each item is described in detail below.

```

CN2510-8                               CN2510-8_5631  V2.0
-----
Info. [Lan] Adv. Host_table Route_table User_table Quit
Examine/modify the Ethernet LAN port setting

ESC: back to menu  Enter: select

Ethernet LAN port 1:
  DHCP (client)           [Disable]
  Async server IP address [192.168.127.254 ]
  Async server IP netmask [255.255.255.0  ]
  Default gateway IP address [      ]
  Ethernet speed         [ ---- ]
  Ethernet address       [00:90:E8:26:10:09]
    
```

DHCP (client)—When DHCP is enabled, CN2510 will request an available IP address and

Netmask over the network from the DHCP Server. If an IP address is not available, CN2510 will use the current IP address, but will continue sending requests to the DHCP Server.

Async server IP address—This field **MUST** contain an IP address unique to the network. The IP address is written using the notation “ddd.ddd.ddd.ddd,” in which each “ddd” is a nonnegative decimal number strictly less than 256 (i.e., an 8-bit integer). The default value is 192.168.127.254.

Async server IP netmask—A netmask is used to group network hosts into subnets. CN2510 sends TCP/IP packets directly to hosts that are on the same subnet. If the recipient of the packet is **NOT** on the same subnet, the packet is sent to the default gateway IP address.

Default gateway IP address—This field contains the IP address of a router on the local network. The default gateway is used when a packet is sent to an IP address that is not on the subnet specified in CN2510's local routing table.

Ethernet speed—If the Ethernet port is active, the Ethernet speed will be set automatically to 10BaseT or 100BaseT. This field cannot be modified.

Ethernet address—This field contains the hardware Ethernet address. This field cannot be modified.

Server Configuration—Adv.

1. From the **MAIN MENU**, use the arrow keys to select **Server**, and then press **Enter**.

```

CN2510-8                      CN2510-8_5631  V2.0                      MAIN MENU
-----
[Server] Port seTting sAve Utility Restart Exit
Examine/modify async server node/table configuration
Enter: select  ESC: previous menu

```

2. From the **SERVER MENU**, select **Adv.**, and then press **Enter**.

```

CN2510-8                      CN2510-8_5631  V2.0                      SERVER MENU
-----
Info. Lan [Adv.] Host_table Route_table User_table Quit
Examine/modify async server basic configuration
Enter: select  ESC: previous menu

```

3. The **Adv.** page contains input/display fields for **RADIUS server IP**, **RADIUS key**, **UDP port**, **Enable RADIUS accounting**, **SNMP community name**, **SNMP trap server IP address**, **Ethernet IP forwarding**, **Routing protocol**, **TCP retransmission timeout**, and **SIO data transfer timeout**. Each item is described in detail below.

```

CN2510-8                               CN2510-8_5631   V2.0
-----
Info. Lan [Adv.] Host_table Route_table User_table Quit
Examine/modify async server advance configuration

ESC: back to menu   Enter:  select

Radius server IP           [                ]
  RADIUS key               [                ]
  UDP port (1:1645 2:1812) [1]
  Enable RADIUS accounting [no ]

SNMP community name       [public          ]
SNMP trap server IP address [                ]

Ethernet IP forwarding    [no ]
Routing protocol          [None ]

TCP retransmission timeout [                ] (range: 50 - 60000 ms)
SIO data transfer timeout [                ] (range: 0 - 1000 ms)

```

RADIUS server IP—The IP address of the RADIUS (Remote Authentication Dial-In User Service) server is used to authenticate remote dial-in users connecting from an ISP (Internet Service Provider). Leave this field blank if you do not have a RADIUS server on your network.

Windows NT includes RADIUS software. For UNIX-based platforms, refer to Appendix B for information about setting up a RADIUS server.

NOTE: The RADIUS server and CN2510 SHOULD be able to communicate with each other. To verify this, check to see if you can ping from each server to the other.

RADIUS server IP—This is the IP address of the RADIUS server.

RADIUS key—This is a shared key used by the RADIUS protocol. If you have a RADIUS server, you will need to enter the password in this field.

UDP port (1:1645 2:1812)—RADIUS originally used port **1645**, but more recently this conflicted with the RFC standard, so the officially assigned RADIUS port is now **1812**. Check which UDP port your RADIUS server software uses to determine the proper choice.

Enable RADIUS accounting—The default for this field is **no**. If your RADIUS Server offers this function, set it to **yes**.

SNMP community name—The SNMP community name can be used to guarantee minimal security for SNMP communication. Only SNMP stations with the same community name can access SNMP agents (such as Async Server). Choose a community name with no more than 16 ASCII characters. The default name is “public.”

SNMP trap server IP address—This field specifies the IP address of the SNMP trap server. CN2510 will report to the SNMP trap server each time it restarts. You may leave this field blank if SNMP is not needed.

Ethernet IP forwarding—CN2510 can forward packets between different segments of a TCP/IP network. When enabled, CN2510 will use its Ethernet routing ability to identify which incoming packets should be forwarded.

Routing protocol—CN2510 supports RIP (Routing Information Protocol) versions 1 and 2, a widely used protocol specifying how routers exchange routing table information. When RIP is activated, routers (or CN2510s) periodically exchange entire routing tables.

TCP retransmission timeout—This is the amount of time CN2510 waits to retransmit after a transmission failure occurs.

SIO data transfer timeout—This is the amount of time (in milliseconds) CN2510 waits to send serial data to the Ethernet. Use a shorter timeout to improve efficiency.

Server Configuration—Host_table

1. From the **MAIN MENU**, use the arrow keys to select **Server**, and then press **Enter**.

```

CN2510-8                               CN2510-8_5631  V2.0                               MAIN MENU
-----
[Server] Port seTting sAve Utility Restart Exit
Examine/modify async server node/table configuration
Enter: select  ESC: previous menu
    
```

2. From the **SERVER MENU**, select **Host_table**, and then press **Enter**.

```

CN2510-8                               CN2510-8_5631  V2.0                               SERVER MENU
-----
Info. Lan Adv. [Host_table] Route_table User_table Quit
Examine/modify async server basic configuration
Enter: select  ESC: previous menu
    
```

3. The **Host_table** contains frequently accessed host names and their corresponding IP addresses. Adding entries to this table gives you the advantage of being able to refer to a host by name, instead of by IP address. The host table can hold up to 16 [Host name] / [Host IP address] entries. The **Host_table** page contains input/display fields for **Entry**, **Host name**, and **Host IP address**.

```

CN2510-8                               CN2510-8_5631  V2.0
-----
Info. Lan Adv. [Host_table] Route_table User_table Quit
Examine/modify the host table
ESC: back to menu  Enter: select

Entry      Host name      Host IP address
01         [      ]      [      ]
02         [      ]      [      ]
03         [      ]      [      ]
04         [      ]      [      ]
05         [      ]      [      ]
06         [      ]      [      ]
07         [      ]      [      ]
08         [      ]      [      ]
    
```

Server Configuration—Route_table

1. From the **MAIN MENU**, use the arrow keys to select **Server**, and then press **Enter**.

```

CN2510-8                               CN2510-8_5631  V2.0                               MAIN MENU
-----
[Server] Port seTting sAve Utility Restart Exit
Examine/modify async server node/table configuration

Enter: select  ESC: previous menu
    
```

2. From the **SERVER MENU**, select **Route_table**, and then press **Enter**.

```

CN2510-8                               CN2510-8_5631  V2.0                               SERVER MENU
-----
Info. Lan Adv. Host_table [Route_table] User_table Quit
Examine/modify async server basic configuration

Enter: select  ESC: previous menu
    
```

3. The **Route_table** specifies routing parameters. The **Route_table** page contains input/display fields for **Entry**, **Gateway**, **Destination**, **Netmask**, and **Metric**. Each item is described in detail below.

```

CN2510-8                               CN2510-8_5631  V2.0
-----
Info. Lan Adv. [Host_table] [Route_table] User_table Quit
Examine/modify the routing table

ESC: back to menu  Enter: select

Entry      Gateway      Destination      Netmask      Metric
01         [             ] [             ] [             ] [01]
02         [             ] [             ] [             ] [01]
03         [             ] [             ] [             ] [01]
04         [             ] [             ] [             ] [01]
05         [             ] [             ] [             ] [01]
06         [             ] [             ] [             ] [01]
07         [             ] [             ] [             ] [01]
08         [             ] [             ] [             ] [01]
    
```

Gateway—The gateway IP address or interface source IP address to which data packets are sent.

Destination—The IP address of a host or network to which the route connects.

Netmask—The netmask of the destination network.

Metric—The number of hops from source to destination. Refer to Chapter 14 for routing settings.

Server Configuration—User_table

1. From the **MAIN MENU**, use the arrow keys to select **Server**, and then press **Enter**.

```

CN2510-8                               CN2510-8_5631  V2.0                               MAIN MENU
-----
[Server] Port seTting sAve Utility Restart Exit
Examine/modify async server node/table configuration

Enter: select  ESC: previous menu
    
```

- From the **SERVER MENU**, select **User_table**, and then press **Enter**.

```

CN2510-8          CN2510-8_5631  V2.0          SERVER MENU
-----
Info. Lan Adv. Host_table Route_table [User_table] Quit
Examine/modify async server basic configuration
Enter: select   ESC: previous menu
    
```

- The **User_table** is used for local authentication for dial-in/out access. The CN2510 User Table, which holds information for up to 64 users, is useful if you do not have an external RADIUS server for authentication. The **User_table** page contains input/display fields for **Entry**, **User name**, **Password**, and **Phone number**.

```

CN2510-8          CN2510-8_5631  V2.0
-----
Info. Lan Adv. Host_table Route_table [User_table] Quit
Examine/modify the user/password table
ESC: back to menu  Enter: select

Entry      User name      Password      Phone number
01         [          ] [          ] [          ]
02         [          ] [          ] [          ]
03         [          ] [          ] [          ]
04         [          ] [          ] [          ]
05         [          ] [          ] [          ]
06         [          ] [          ] [          ]
07         [          ] [          ] [          ]
08         [          ] [          ] [          ]
    
```

Save

When exiting the **SERVER MENU**, you will be prompted to save settings. Press **Y** to save.

```

CN2510-8          CN2510-8_5631  V2.0          MAIN MENU
-----
Info. Lan Adv. Host_table Route_table [User_table] Quit
Examine/modify async server basic configuration
Enter: select   ESC: previous menu

+-----+
| Warning !!! |
| You had modified the configuration without saving. |
| Would you save it now ? |
| 'Y': yes    'N': no |
+-----+
    
```

You may also save all settings from the **MAIN MENU** by selecting **sAve**.

```

CN2510-8          CN2510-8_5631  V2.0
-----
Server Port seTting [sAve] Utility Restart Exit
Save current configuration to Flash ROM
ESC: back to menu  Enter: select

+-----+
| Enter to updated, other key to cancel |
+-----+
    
```

Knowing Your Application

This chapter discusses a variety of applications for CN2510 Async Server. Refer to the diagrams in each section to see which application most closely matches your own. Determining which application you should choose will save time configuring both the hardware and software.

CN2510 is an Async Server that can support simultaneously different operation modes for different serial ports. The examples in this chapter explain each operation mode in detail. You can create a wide variety of applications by using different combinations of operation modes on the same Async Server.

NOTE: Each section title consists of an application name that uses terminology common to our industry, followed in parentheses by the application name used in CN2510's console utility. For example, the CN2510 application that corresponds to Linux Real TTY/Unix Fixed TTY is NT Real COM mode.

The following topics are covered in this chapter:

- Windows Real COM (NT Real COM)**
- Linux Real TTY/Unix Fixed TTY (NT Real COM)**
- Device Control (Device Control)**
- UDP Communication (Raw UDP)**
- Console Management (Reverse Terminal)**
- Terminal Access (Terminal)**
- Multi-host TTY (Multi-host TTY)**
- Dial-in/Out-of-Band Management (Dialin/out)**
- Network Printer (Printer)**
- Multiplexor Access (Multiplex)**

Windows Real COM (NT Real COM)

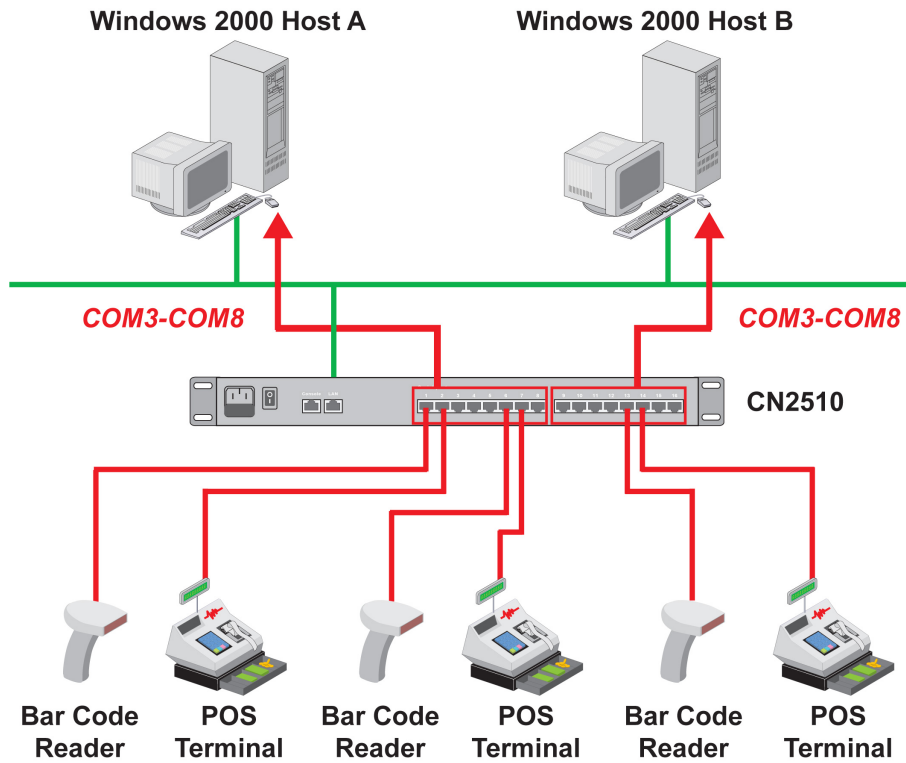

Moxa provides CN2510 COM port drivers for all Windows operating systems. The COM port driver serves a dual purpose—(1) convert serial data into Ethernet packets, (2) convert Ethernet packets into serial data—as outlined in the following table:

PC → CN2510 → Serial Device	Serial Device → CN2510 → PC
<ol style="list-style-type: none"> 1. The PC generates RS-232 serial COM commands. 2. The COM port driver converts the commands into Ethernet packets. 3. The packets are sent over the network to CN2510's Ethernet port. 4. CN2510 converts the Ethernet packets back into RS-232 serial format. 5. The commands are delivered to serial device(s) connected to CN2510's serial port(s). 	<ol style="list-style-type: none"> 1. A serial device connected to CN2510 starts transmitting serial data. 2. CN2510 converts the data into one or more Ethernet packets. 3. The packets are sent over the network to the PC host's Ethernet port. 4. The COM port driver converts the Ethernet packets back into RS-232 serial format. 5. The serial data is processed by the program that controls the serial device.

You can enhance your applications greatly by using CN2510 to access serial devices over an Ethernet network, and since CN2510 and the COM driver handle all protocol conversion tasks, you won't need to modify the software currently in use. In fact, multiple PCs can access the serial ports of one CN2510, as shown in the figure.

Refer to Chapter 4 for detailed information and configuration instructions.

Linux Real TTY/Unix Fixed TTY (NT Real COM)

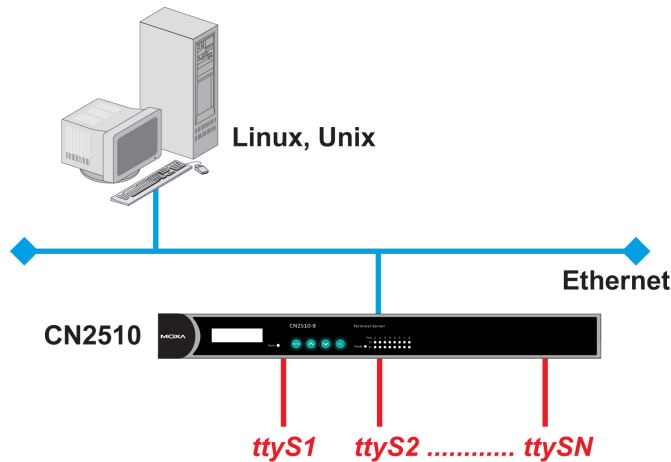

Real TTY drivers that control Moxa CN2510 Async Server's serial ports are provided for Linux environments. This means that CN2510 Async Server can be used with existing Linux-based applications that use multiport serial boards, since the host PC will recognize CN2510's COM ports as real TTY ports. You can enhance your applications by using CN2510 to access serial devices over an Ethernet network, but without needing to modify the software currently in use.

Moxa also provides Fixed TTY port drivers for Unix environments. However, the Linux Real TTY and Windows Real COM port drivers provide better control over serial port data transmission, since you can control modem signals such as DTR, DSR, RTS, and CTS. The Unix Fixed TTY driver provides software reception and transmission through CN2510's serial ports, but does not allow you to control the DTR, DSR, RTS, and CTS modem signals.

Refer to Chapter 4 for detailed information and configuration instructions.

Device Control (Device Control)

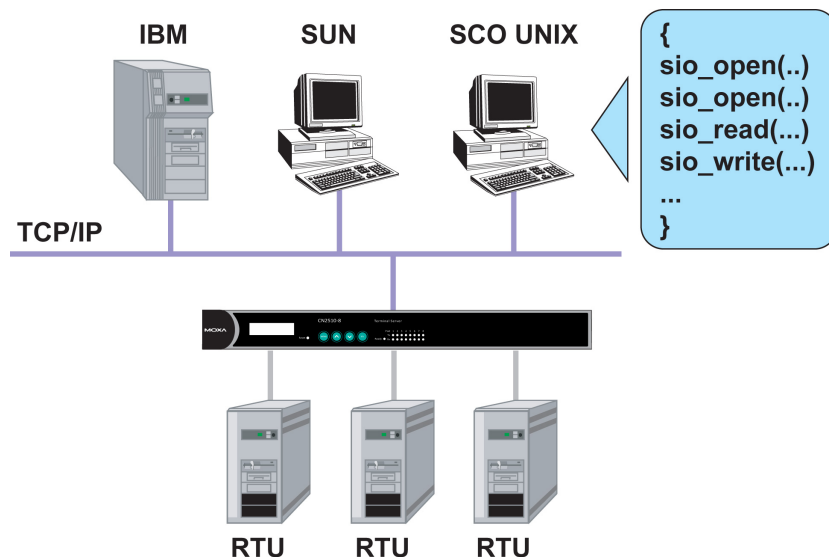

The CN2510 Device Control application allows you to choose between two different operation modes: ASPP and RAW.

ASPP Mode—For applications that require setting up communication parameters or controlling modem signals (DTR, RTS, Break, etc.), take advantage of Moxa's ASPP lib to simplify your programming tasks. ASPP takes care of the more basic protocol-level programming tasks, and allows you to concentrate your energy on higher level, application-specific tasks.

RAW Mode—To control device data transmission directly, set CN2510 for TCP RAW mode. Device control applications can use standard Linux/Unix Socket programming in Linux/Unix environments, or WinSock programming in Windows environments. Standard socket programming allows you to focus on pure data transmission, without needing to write code for controlling serial ports or modem signals. ASPP can also be used to communicate with CN2510.

Linux/Unix socket programming and Windows WinSock programming both use IP as the communication agent between hosts and devices. RAW mode is a good solution for handling pure serial data communications applications that do not require setting up communication parameters (baud rate, parity, etc.).

Refer to Chapter 5 for detailed information and configuration instructions.

UDP Communication (Raw UDP)

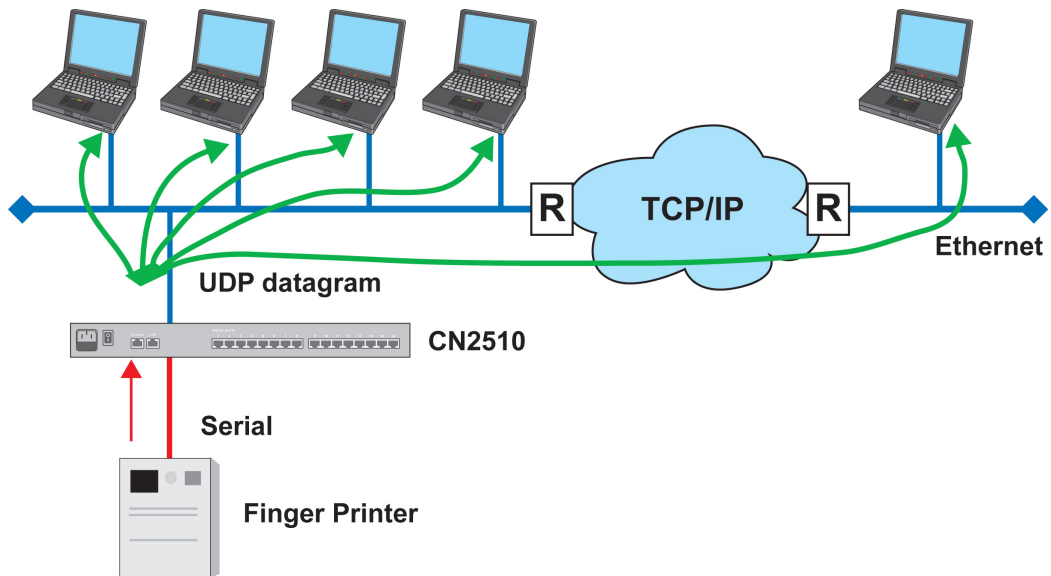

UDP is a non connection-oriented data transmission protocol that has the advantages of efficient, high-speed, high-volume data transmission. Since UDP does not use TCP's handshaking procedure, it does not re-assemble and retransmit packets when data is missing. This means that data integrity is sacrificed for higher transmission speed. UDP provides a very powerful transmission method when data needs to be transmitted quickly over the network, and upper-level application software is given the responsibility of verifying the accuracy of the data.

UDP can also use broadcasting or multicasting technologies to handle point to multi-point transmissions. UDP is an ideal transmission method for serial devices that must transmit data to a group of devices or PCs.

Refer to Chapter 6 for detailed information and configuration instructions.

Console Management (Reverse Terminal)

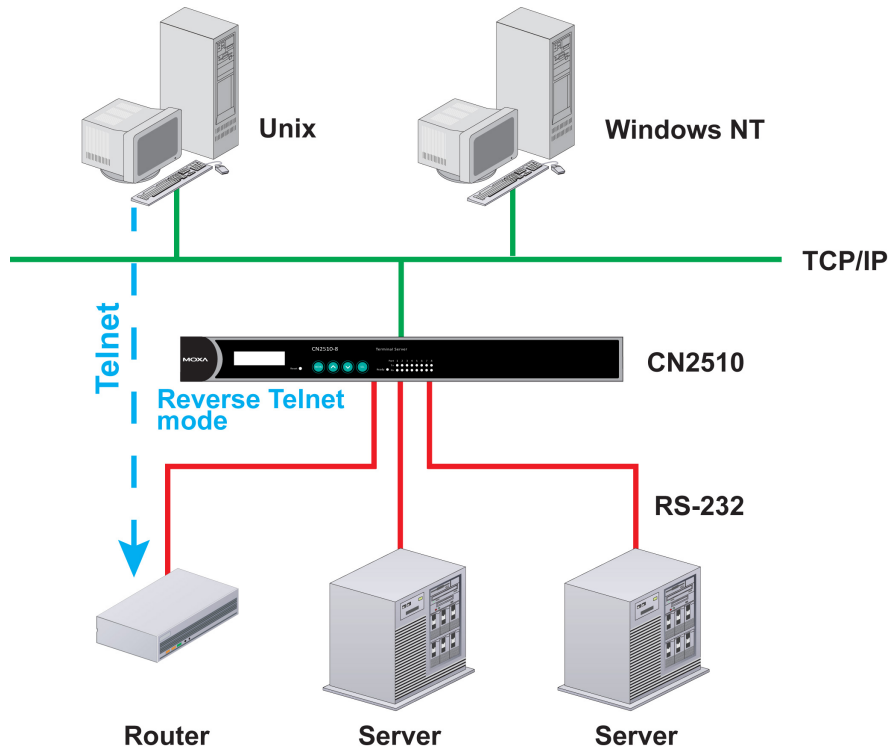

The Reverse Terminal application, which uses Rtelnet mode, is used with routers, switches, and UPS equipment for console management applications. Rtelnet mode is similar to RAW mode, in that after booting up it listens to one specific TCP port for network hosts to initiate a connection. RAW mode, however, does not provide a Telnet conversion function. If the serial devices connected to CN2510 need to use the CR/LF conversion function, then Rtelnet mode must be used. CN2510's Rtelnet mode is also used widely for device management applications in telecommunication control rooms, since remote hosts can make use of Local User Table or RADIUS identity verification methods.

Refer to Chapter 7 for detailed information and configuration instructions.

Terminal Access (Terminal)

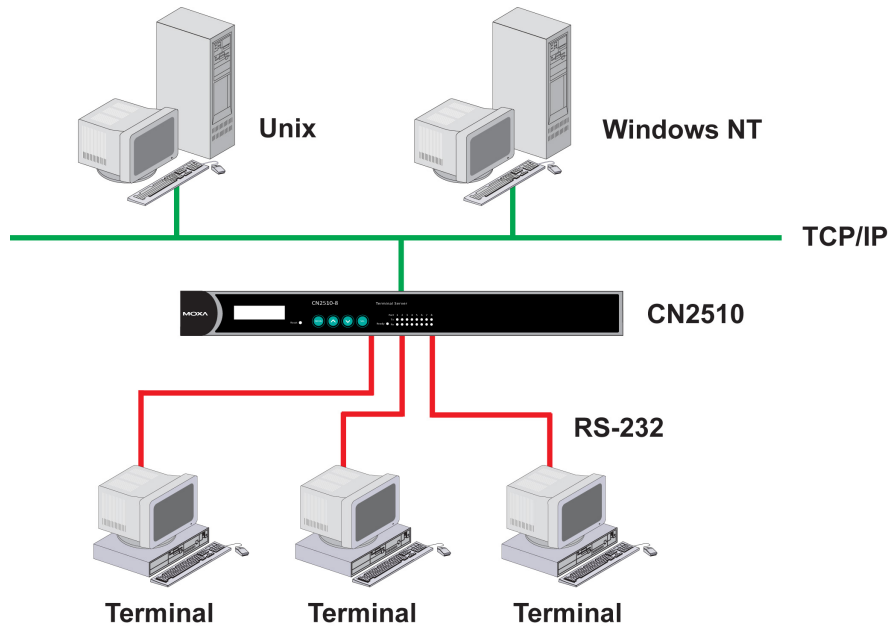

CN2510's Terminal Access application is used to connect terminals to Unix or Windows Servers over a network. The terminals connect to CN2510's serial ports at a remote site, with terminal commands transmitted over the network via CN2510's Ethernet port. The Terminal Access application allows you to use fast keys used in many terminal applications, and switching sessions on the same terminal. CN2510 supports ASCII terminal and Binary terminal, with up to 8 simultaneous sessions for each port.

Refer to Chapter 8 for detailed information and configuration instructions.

Multi-host TTY (Multi-host TTY)

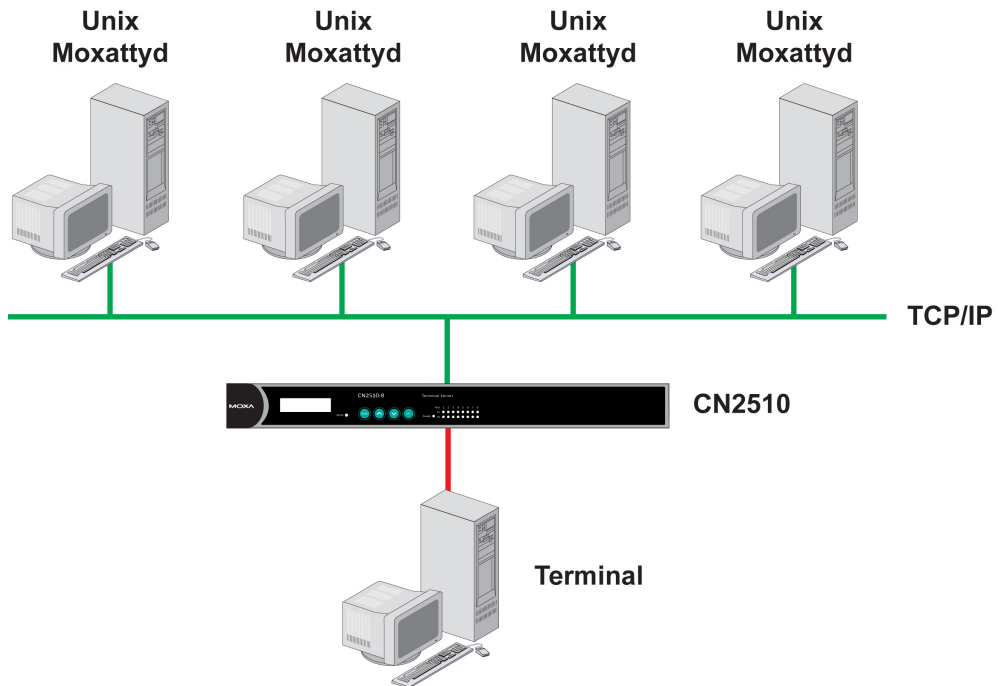

**Use hot key to swith sessions
between different Unix servers**

The Multi-host TTY application is ideal for connecting over a network to multiple Unix hosts from several sessions simultaneously. When communication begins, the networked Unix server must first enable Moxattyd to activate the TTY port's mapping function. Moxattyd will initiate the connection with the CN2510, and the CN2510 will listen to the connection requests issued by various Moxattyd over different TCP ports.

Once the connection is established, the Terminal server can use hot keys to switch sessions, allowing one terminal to control different Unix hosts.

Refer to Chapter 9 for detailed information and configuration instructions.

Dial-in/Out-of-Band Management (Dialin/out)

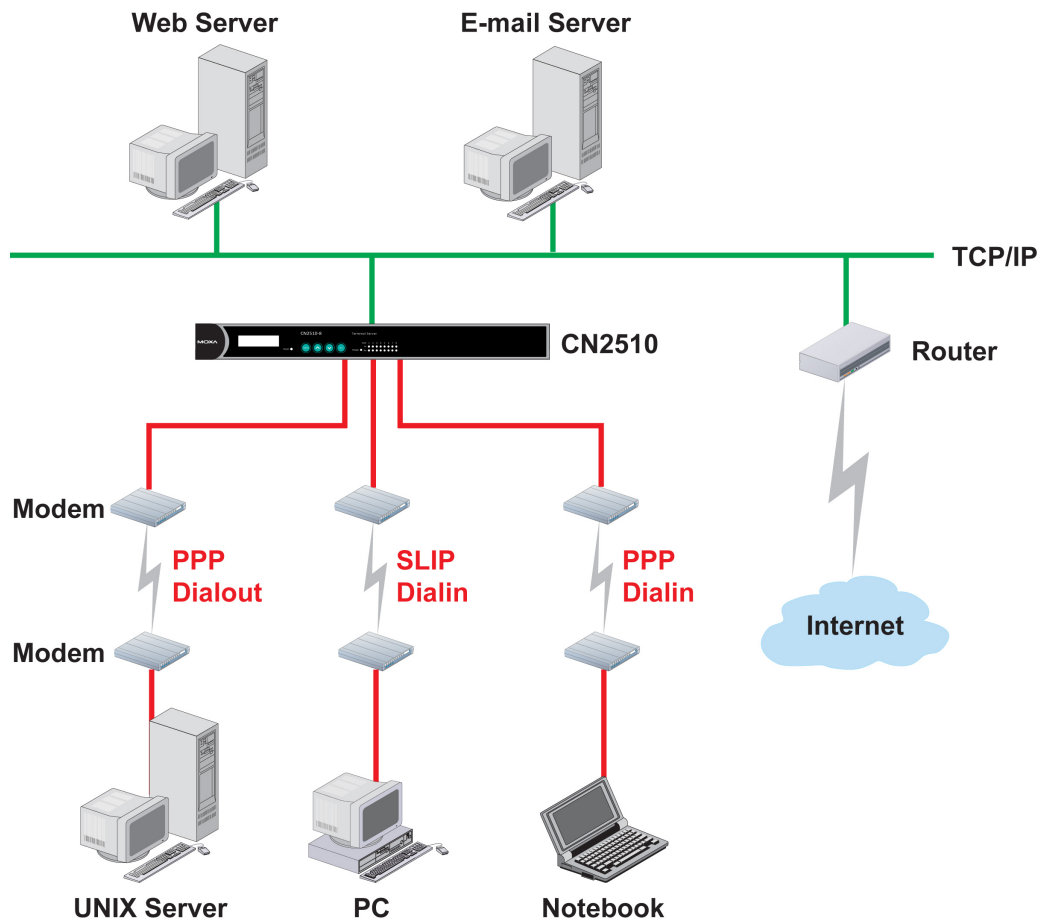

Moxa CN2510 Async Server provides dial-up/dial-out access for ISPs and enterprises that need a remote access solution. When a user at a remote site uses a PPP dial-up connection to access CN2510, CN2510 plays the role of dial-up server, but also ensures the user has legal access to the network by verifying the user's identity with its Local User Table or RADIUS.

CN2510 supports PPP, SLIP, and Terminal modes for dial-up/dial-out access. Regardless of which OS is used, you will always be able to use standard PPP dial-up to establish a connection. CN2510 can also act as an Async router to connect serial ports to a WAN connection. Routing protocols (including static, RIP I, and RIP II) can be adjusted to route different WAN connections.

Refer to Chapter 10 for detailed information and configuration instructions.

Network Printer (Printer)

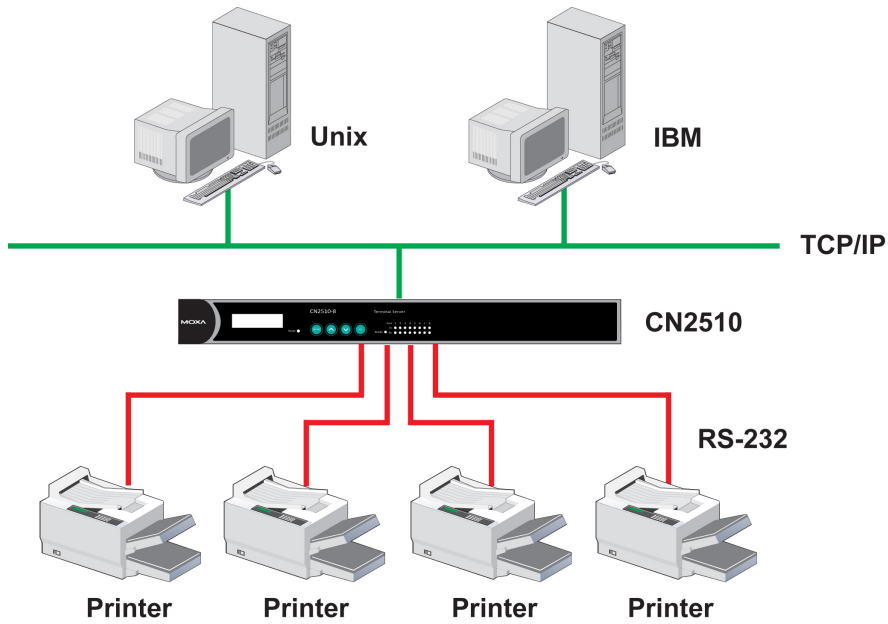

CN2510 Async Server's printing program (running under UNIX) provides an excellent solution for banking and stock exchange services with huge printing demands. Use a Windows or Unix host's network printer function via RAW mode, and assign a specific IP address and TCP port number to specify the printer's location. You can also connect to the printer via LPD mode when LPD protocol is needed to operate the printer.

Refer to Chapter 11 for detailed information and configuration instructions.

Multiplexor Access (Multiplex)

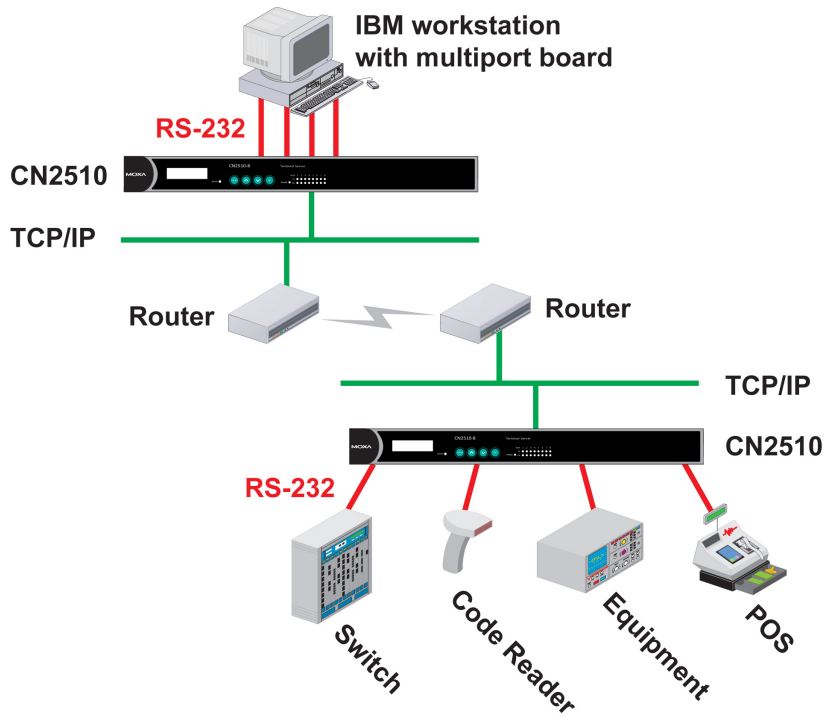

If you are using a multiport serial board installed in a UNIX host, but wish to extend the device control range without dismantling the host, you can accomplish this with CN2510. Multiplex and De-multiplex solutions use CN2510's RTelnet and terminal modes, eliminating the need to modify existing software. CN2510 acts like a converter by extending the communication distance. CN2510s work in pairs over the network to overcome the short communication distance limitation imposed by serial connections.

See Chapter 12 for detailed configuration instructions.

NOTE: This mode does not allow copying the status of control signals to devices at a remote site.

Setting Up Windows Real COM/Linux Real TTY/Unix Fixed TTY

CN2510 Async Server supports Real COM/TTY drivers for Windows and Linux, allowing CN2510's serial ports to be recognized as Real COM ports by the Windows operating system, or Real TTY ports by Linux operating systems. CN2510 Async Server can be used for a variety of applications to make the serial ports accessible over an Ethernet, but without the need to modify existing serial transmission software. The Real COM driver provided by Moxa lets users treat networked serial ports the same as local serial ports.

The following topics are covered in this chapter:

- Accessing the Console Utility**
- Selecting the Application**
- Configuring ASPP Mode**
- Configuring the Serial Ports**
- Save**
- Restart**
- Setting up Hosts**
 - Setting up Windows XP/2003 Hosts
 - Setting up Windows 2000 Hosts
 - Setting up Windows 95/98/ME/NT Hosts

Accessing the Console Utility

NOTE In this section, we show how to access CN2510's console utility by Telnet over the network. For information on using the console port, see the section "Accessing the Console Utility" in Chapter 2.

1. Telnet over the network to the server's IP address.

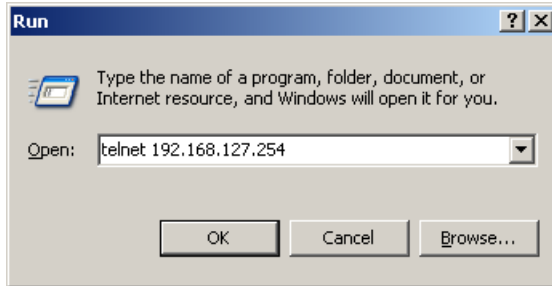

2. Type **1** to choose **ansi/vt100**, and then press **Enter**.

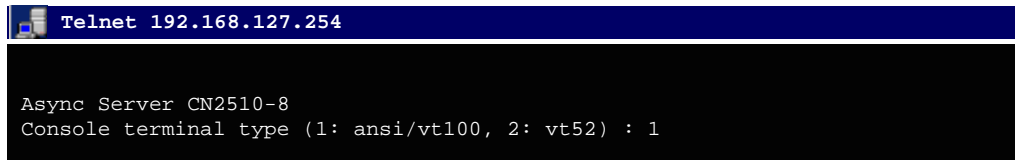

3. CN2510's **MAIN MENU** will open, as shown below.

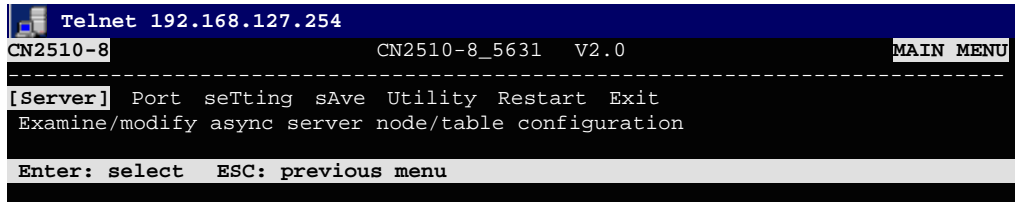

Use the following keystrokes to navigate CN2510's console utility.

Action	Key
Move	[Up/Down/Left/Right] Arrow Key or [Tab] Key
Jump to next menu, or Select item	[Enter] Key
Return to previous menu, or Close pop up selector	[Esc] Key
Shortcut Key	Capitalized letter of the word

Selecting the Application

Open **Port Menu** → **Mode** to configure the **NT Real COM** application.

- From the **MAIN MENU**, select **Port**, and then press **Enter**.

```

CN2510-8          CN2510-8_5631  V2.0          MAIN MENU
-----
Server [Port] seTting sAve Utility Restart Exit
Examine/modify async server ports configuration
Enter: select  ESC: previous menu
    
```

- From the **PORT MENU**, select **Mode**, and then press **Enter**.

```

CN2510-8          CN2510-8_5631  V2.0          PORT MENU
-----
[Mode] Line mOdem Welcome_MSG Quit
Examine/modify the operation mode of async ports
Enter: select  ESC: previous menu
    
```

- The **Mode** page has pop-up selection lists for **Application**, **Mode**, and **Description/more setting** for each serial port. Use the arrow keys to move the cursor to the **Application** column for the port to be configured, and then press **Enter**. We use Port 6 to illustrate.

```

CN2510-8          CN2510-8_5631  V2.0
-----
[Mode] Line mOdem Welcome_MSG Quit
Examine/modify the operation mode of async ports
ESC: back to menu  Enter: select

Port  Application          Mode          Description/more setting
01   [NT Real COM ] [ASPP ] [Async Server Proprietary Protocol]
02   [NT Real COM ] [ASPP ] [Async Server Proprietary Protocol]
03   [NT Real COM ] [ASPP ] [Async Server Proprietary Protocol]
04   [NT Real COM ] [ASPP ] [Async Server Proprietary Protocol]
05   [NT Real COM ] [ASPP ] [Async Server Proprietary Protocol]
06   [NT Real COM ] [ASPP ] [Async Server Proprietary Protocol]
07   [NT Real COM ] [ASPP ] [Async Server Proprietary Protocol]
    
```

- Use the **Up/Down** arrow keys to select **NT Real COM**, and then press **Enter**.

```

CN2510-8          CN2510-8_5631  V2.0
-----
[Mode] Line mOdem Welcome_MSG Quit
Examine/modify the operation mode of async ports
ESC: back to menu  Enter: select

Port  Application          +-----+ption/more setting
01   [NT Real COM ] | Disable | Server Proprietary Protocol]
02   [NT Real COM ] | Dialin/out | Server Proprietary Protocol]
03   [NT Real COM ] | Terminal | Server Proprietary Protocol]
04   [NT Real COM ] | Reverse Terminal | Server Proprietary Protocol]
05   [NT Real COM ] | Device Control | Server Proprietary Protocol]
06   [NT Real COM ] | Multiplex | Server Proprietary Protocol]
07   [NT Real COM ] | Printer | Server Proprietary Protocol]
08   [NT Real COM ] | Multi-Host TTY | Server Proprietary Protocol]
      | NT Real COM |
      | Raw UDP |
      +-----+
    
```

- ASPP mode is selected by default, since it is the only mode associated with the NT Real COM application.

```

CN2510-8          CN2510-8_5631  V2.0
-----
[Mode] Line mOdem Welcome_MSG Quit
Examine/modify the operation mode of async ports

ESC: back to menu  Enter:  select

Port Application      Mode      Description/more setting
01 [NT Real COM      ] [ASPP   ] [Async Server Proprietary Protocol]
02 [NT Real COM      ] [ASPP   ] [Async Server Proprietary Protocol]
03 [NT Real COM      ] [ASPP   ] [Async Server Proprietary Protocol]
04 [NT Real COM      ] [ASPP   ] [Async Server Proprietary Protocol]
05 [NT Real COM      ] [ASPP   ] [Async Server Proprietary Protocol]
06 [NT Real COM      ] [ASPP   ] [Async Server Proprietary Protocol]
07 [NT Real COM      ] [ASPP   ] [Async Server Proprietary Protocol]
08 [NT Real COM      ] [ASPP   ] [Async Server Proprietary Protocol]
    
```

Configuring ASPP Mode

Follow these steps to configure ports for ASPP mode:

- Move the cursor to the **Description/more setting** column and press **Enter**.

```

CN2510-8          CN2510-8_5631  V2.0
-----
[Mode] Line mOdem Welcome_MSG Quit
Examine/modify the operation mode of async ports

ESC: back to menu  Enter:  select

Port Application      Mode      Description/more setting
01 [NT Real COM      ] [ASPP   ] [Async Server Proprietary Protocol]
02 [NT Real COM      ] [ASPP   ] [Async Server Proprietary Protocol]
03 [NT Real COM      ] [ASPP   ] [Async Server Proprietary Protocol]
04 [NT Real COM      ] [ASPP   ] [Async Server Proprietary Protocol]
05 [NT Real COM      ] [ASPP   ] [Async Server Proprietary Protocol]
06 [NT Real COM      ] [ASPP   ] [Async Server Proprietary Protocol]
07 [NT Real COM      ] [ASPP   ] [Async Server Proprietary Protocol]
08 [NT Real COM      ] [ASPP   ] [Async Server Proprietary Protocol]
    
```

- The pop-up selector contains input/display fields for **TCP data port**, **TCP command port**, and **TCP alive check time**. Each item is described in detail below the figure.

```

CN2510-8          CN2510-8_5631  V2.0
-----
[Mode] Line mOdem Welcome_MSG Quit
Examine/modify the operation mode of async ports

ESC: back to menu  Enter:  select

Port Application      Mod+-----+
01 [NT Real COM      ] [AS| TCP data port      : [950]      |]
02 [NT Real COM      ] [AS| TCP command port   : [966]      |]
03 [NT Real COM      ] [AS| TCP alive check time : [0 ] minutes |]
04 [NT Real COM      ] [AS+-----+
05 [NT Real COM      ] [ASPP ] [Async Server Proprietary Protocol]
06 [NT Real COM      ] [ASPP ] [Async Server Proprietary Protocol]
    
```

Setting	Value	Notes	Necessity												
TCP data port	950 – 965	The host uses this port number to determine which serial device to send data to. These values are fixed, and cannot be changed by the user. <table border="1" style="width: 100%; border-collapse: collapse;"> <thead> <tr> <th style="text-align: left;">Serial Port</th> <th style="text-align: left;">TCP Port No.</th> </tr> </thead> <tbody> <tr><td>01</td><td>950</td></tr> <tr><td>02</td><td>951</td></tr> <tr><td>03</td><td>952</td></tr> <tr><td>...</td><td>...</td></tr> <tr><td>16</td><td>965</td></tr> </tbody> </table>	Serial Port	TCP Port No.	01	950	02	951	03	952	16	965	Required
Serial Port	TCP Port No.														
01	950														
02	951														
03	952														
...	...														
16	965														
TCP command port	966 – 981	The host uses this port number to determine which device to send commands to. These values are fixed, and cannot be changed by the user. <table border="1" style="width: 100%; border-collapse: collapse;"> <thead> <tr> <th style="text-align: left;">Serial Port</th> <th style="text-align: left;">TCP Port No.</th> </tr> </thead> <tbody> <tr><td>01</td><td>966</td></tr> <tr><td>02</td><td>967</td></tr> <tr><td>03</td><td>968</td></tr> <tr><td>...</td><td>...</td></tr> <tr><td>16</td><td>981</td></tr> </tbody> </table>	Serial Port	TCP Port No.	01	966	02	967	03	968	16	981	Required
Serial Port	TCP Port No.														
01	966														
02	967														
03	968														
...	...														
16	981														
TCP alive check time	0 – 99 min. (default = 7 min)	The time period CN2510 waits before checking if the TCP connection is alive or not. If no response is received, CN2510 will reset the port and terminate the connection.	Optional												

3. Press **ESC** to return to the **PORT MENU**.

Configuring the Serial Ports

Open **Port Menu** → **Line** to configure serial port settings.

1. From the **MAIN MENU**, select **Port**, and then press **Enter**.

```

CN2510-8                               CN2510-8_5631  V2.0                               MAIN MENU
-----
Server [Port] seTting sAve Utility Restart Exit
Examine/modify async server ports configuration
Enter: select  ESC: previous menu
    
```

2. From the **PORT MENU**, select **Line**, and then press **Enter**.

```

CN2510-8                               CN2510-8_5631  V2.0                               PORT MENU
-----
Mode [Line] mOdem Welcome_MSG Quit
Examine/modify asynchronous port configuration
Enter: select  ESC: previous menu
    
```

- 3. The **Line** page has pop-up selection lists for **Port**, **Speed**, **Bits**, **Stop**, **Parity**, **FIFO**, **RTS/CTS**, **XON/XOFF**, and **Discon. ctrl** for each serial port. Each item is described in detail below the figure.

```

CN2510-8           CN2510-8_5631  V2.0
-----
Mode [Line]  mOdem  Welcome_MSG  Quit
Examine/modify asynchronous port configuration

ESC: back to menu  Enter: select

Port  Speed  Bits  Stop  Parity  FIFO  RTS/CTS  XON/XOFF  Discon. ctrl
01  [115200] [8]  [ 1 ] [None ] [yes]  [yes]  [no ]  [None ]
02  [115200] [8]  [ 1 ] [None ] [yes]  [yes]  [no ]  [None ]
03  [115200] [8]  [ 1 ] [None ] [yes]  [yes]  [no ]  [None ]
04  [115200] [8]  [ 1 ] [None ] [yes]  [yes]  [no ]  [None ]
05  [115200] [8]  [ 1 ] [None ] [yes]  [yes]  [no ]  [None ]
06  [115200] [8]  [ 1 ] [None ] [yes]  [yes]  [no ]  [None ]
07  [115200] [8]  [ 1 ] [None ] [yes]  [yes]  [no ]  [None ]
08  [115200] [8]  [ 1 ] [None ] [yes]  [yes]  [no ]  [None ]

```

Setting	Value	Notes
Speed	50 bps to 921.6 Kbps	Transmission rate
Bits	5, 6, 7, 8	Data bits
Stop	1, 1.5, 2	Stop bits
Parity	None, Even, Odd, Mark, Space	Odd, Even, Mark, Space
FIFO	Yes, No	First In First Out Device
RTS/CTS	Yes, No	Hardware Flow Control
XON/XOFF	Yes, No	Software Flow Control
Discon. Ctrl	None	DSR off or DCD off will not be interpreted as a disconnection.
	DSR off	DSR off will be interpreted as a disconnection.
	DCD off	DCD off will be interpreted as a disconnection.

- 4. Press **ESC** to return to the **PORT MENU**.

Save

When exiting the **SERVER MENU**, you will be prompted to save settings. Press **Y** to save.

```

CN2510-8           CN2510-8_5631  V2.0           SERVER MENU
-----
Info. Lan Adv. Host_table  Route_table  [User_table]  Quit
Examine/modify async server basic configuration

Enter: select  ESC: previous menu

+-----+
|                                     |
|                               Warning !!! |
| You had modified the configuration without saving. |
| Would you save it now ? |
|         'Y': yes         'N': no         |
|                                     |
+-----+

```

You may also save all settings from the **MAIN MENU** by selecting **sAve** and then pressing **Enter**. Press **Enter** again to save, and any other key to cancel.

```

CN2510-8          CN2510-8_5631  V2.0          MAIN MENU
-----
Server Port seTting [sAve] Utility Restart Exit
Save current configuration to Flash ROM
ESC: back to menu  Enter:  select

+-----+
|Enter to updated, other key to cancel|
+-----+

```

Restart

1. From the **MAIN MENU**, select **Restart**.

```

CN2510-8          CN2510-8_5631  V2.0          MAIN MENU
-----
Server Port seTting sAve Utility [Restart] Exit
Restart the whole system or selected async ports
Enter: select  ESC: previous menu

```

2. Select **System** and then press **Enter** to restart the system and terminate the Telnet session.

```

CN2510-8          CN2510-8_5631  V2.0
-----
[System] Port Quit
Restart the Async Server
ESC: back to menu  Enter:  select

+-----+
|Warning !!!|
|Restart system will disconnect all ports and clear all status value|
|Enter: continue  ESC: cancel|
+-----+

```

Setting up Hosts

After using CN2510 Console Utility to set up Async Server's ports for the NT Real COM application (ASPP mode), you will need to install port drivers on every computer used to access CN2510's ports. In this section we explain how to set up Windows hosts

Setting up Windows XP/2003 Hosts

In this section, we use Windows XP to illustrate the installation procedure. The installation procedure for Windows 2003 machines is identical.

Installing a Server

1. Unzip the Windows XP/2003 driver file, located on the CN2510 CD ROM, to your hard disk.
2. Run the Windows **Add Hardware Wizard**, located in the **Control Panel**.



3. When the **Welcome to the Add Hardware Wizard** window opens, click on **Next** to continue.



4. Wait patiently while the Wizard searches for servers connected to the network.

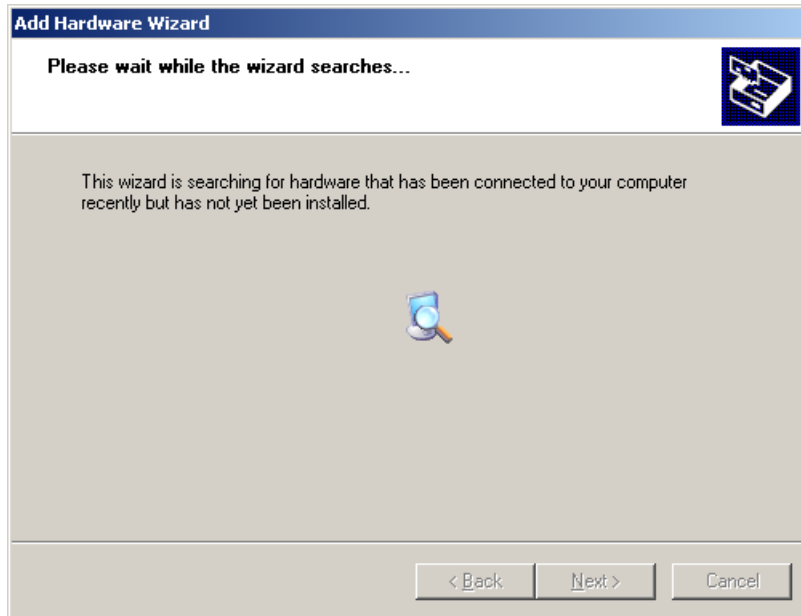

5. The next window to open will ask you if the hardware is connected. Select **Yes, I have already connected the hardware**, and click on **Next** to continue.

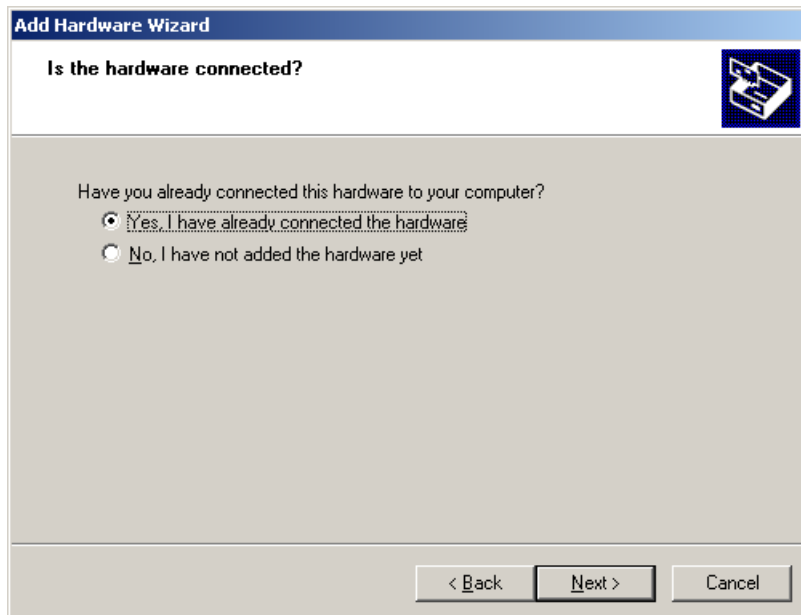

6. Select **Add a new hardware device**, and then click on **Next** to continue.

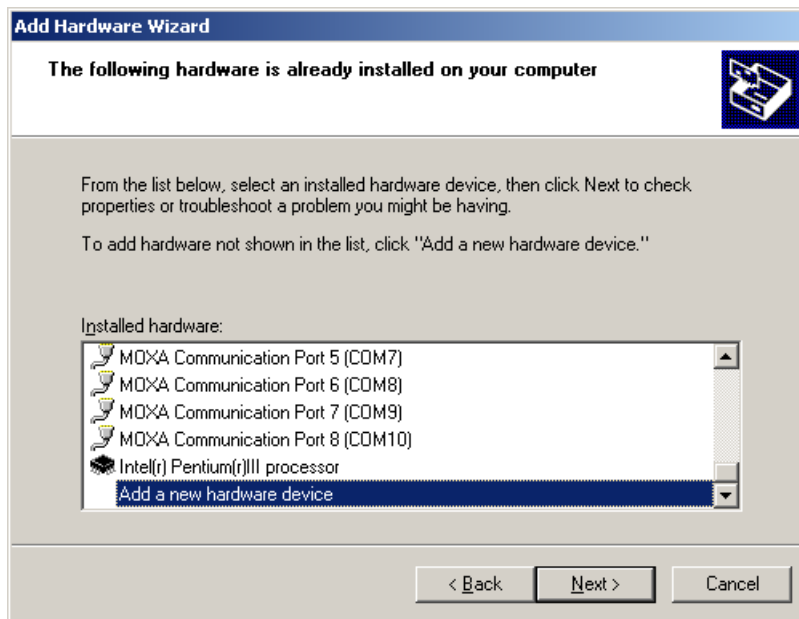

7. Select **Install the hardware that I manually select from a list (Advanced)** to install the hardware, and then click on **Next** to continue.

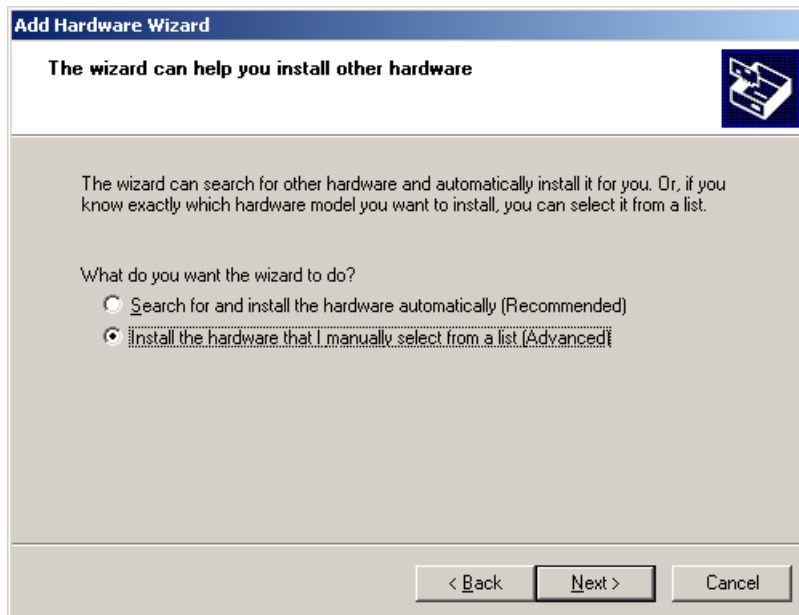

8. The window that opens next will ask you to select the type of hardware you are installing. Select **Multi-port serial adapters**, and then click on **Next** to continue.

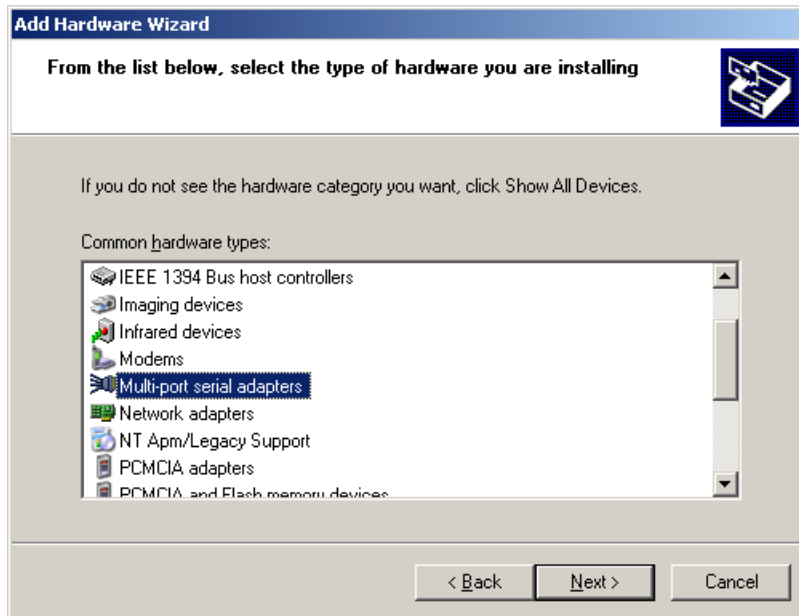

9. The window that opens next will ask you to select the device driver you want to install for this hardware. Click on **Have Disk...** to install from the CD.

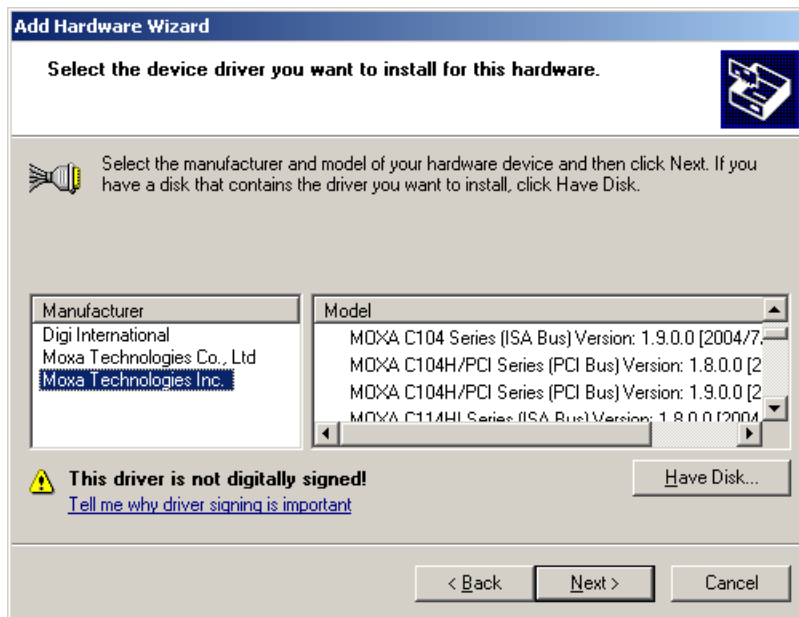

10. Locate and then select the driver file **NPSEVER.INF**. Click on **Open** to proceed with the installation.

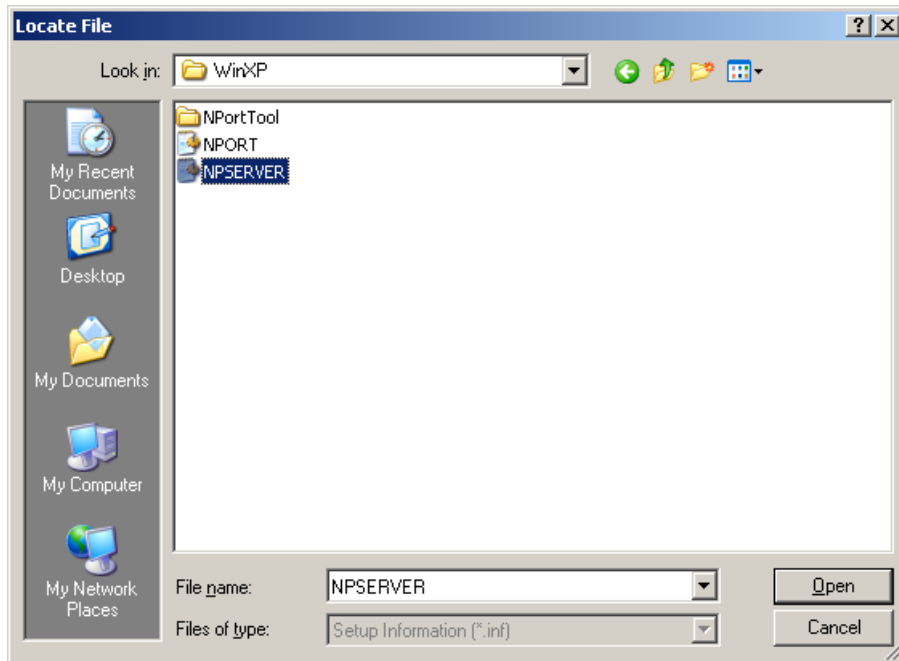

11. Select the correct CN2510 model, and then click on **Next** to continue.

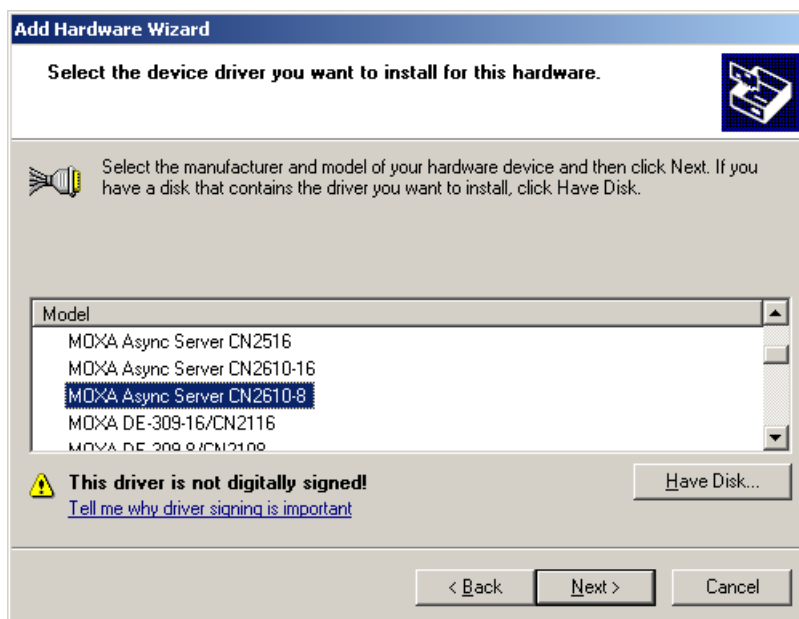

- 12. The Wizard will start installing the driver, and automatically search the network for copies of the CN2510 model you selected in the previous step.

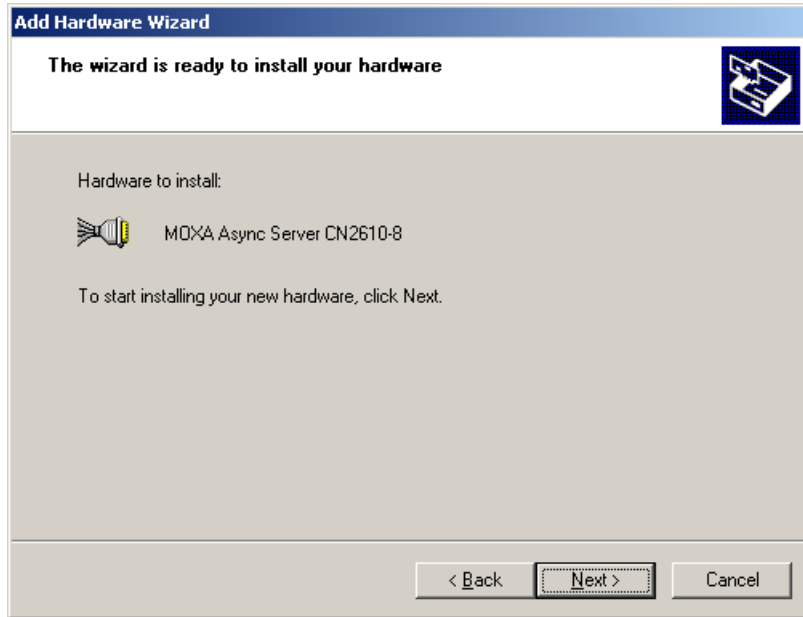

- 13. Although the next window to open states that the software hasn't passed Windows Logo testing, you can rest assured that this driver has already been tested and been shown that it can support this Windows OS. Click on **Continue Anyway** to proceed.

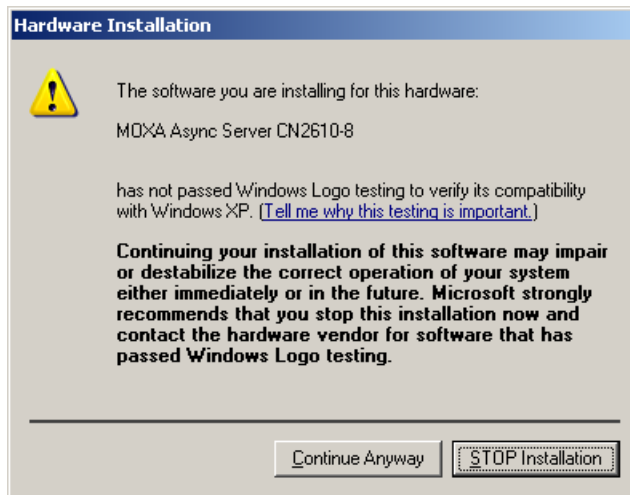

- 14. Wait patiently while the driver is installed.

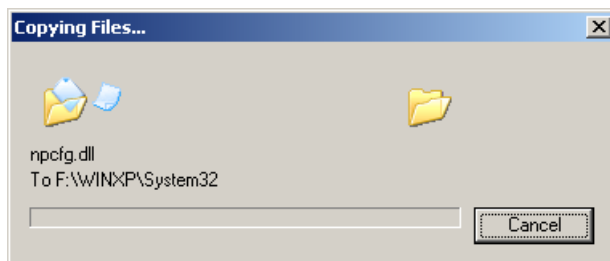

15. You can select the CN2510 that was located automatically, or select **Manually Enter the IP address of NPort Server / Async Server** and then enter the IP address of a different server. Click on **Next** to finish installing the CN2510 driver.

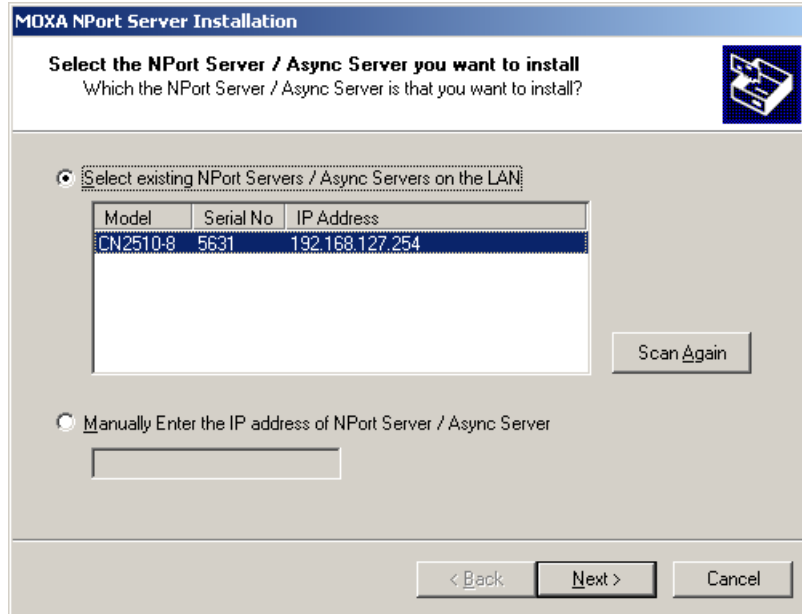

16. The next window reports that the driver was installed, and port drivers will be installed next. Click on **Next** to continue.

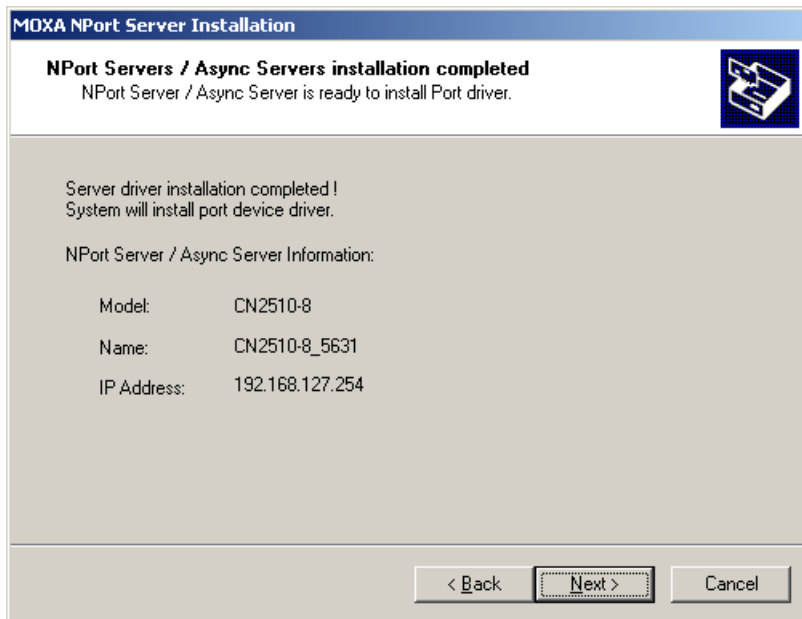

- Click on **Finish** to complete the installation of the server driver. This will automatically trigger the port installation procedure.



Installing Ports

- After the CN2510 server driver has been installed, Windows will notify you that new hardware has been found. Select **Install from a list or specific location (Advanced)**, and then click on **Next** to continue.

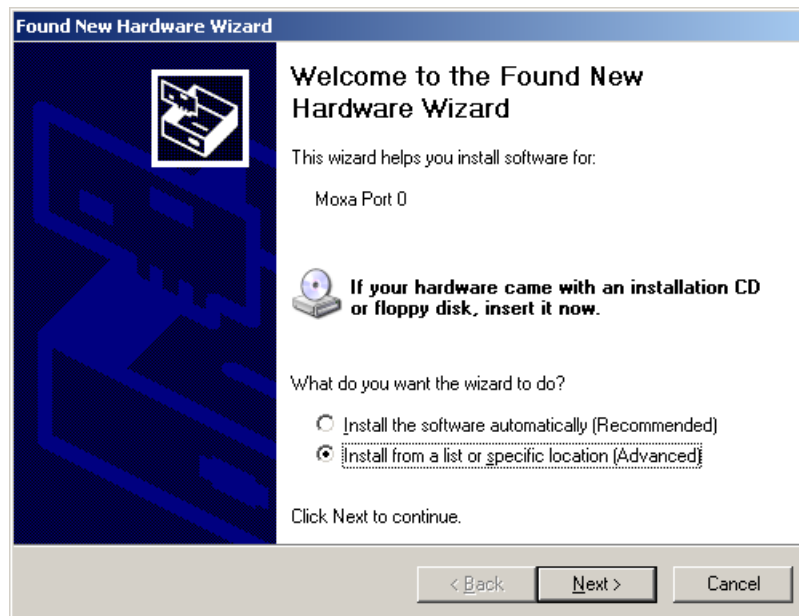

2. Select **Include this location in the search**, and then click on **Next** to continue.

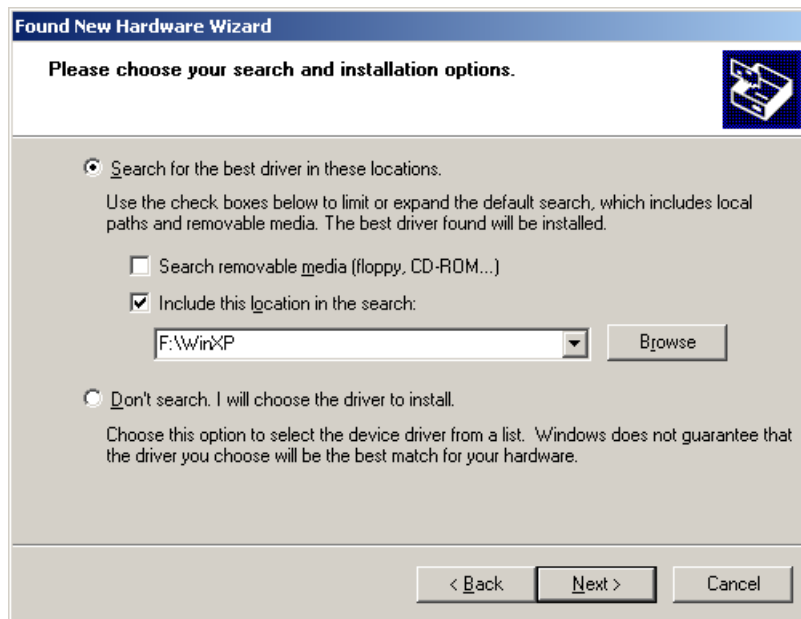

3. Although the next window to open states that the software hasn't passed Windows Logo testing, you can rest assured that this driver has already been tested and been shown that it can support this Windows OS. Click on **Continue Anyway** to proceed.



- The driver for Moxa Port 0 will be installed.

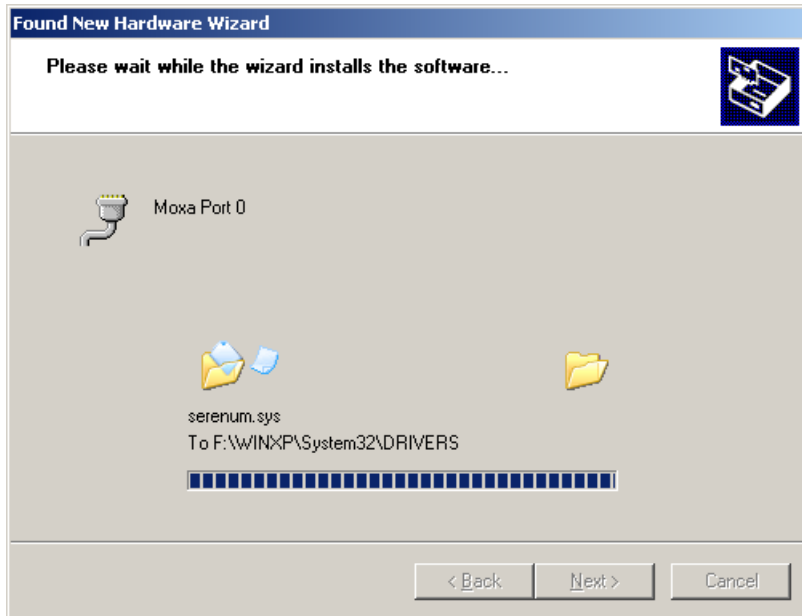

- After Moxa Port 0 is installed, steps 1 to 4 will be repeated 7 or 15 times, depending on whether you are installing drivers for the 8-port or 16-port CN2510.



6. After the installation is complete, you can check **Ports (COM & LPT)** under **Device Manager** to verify that all of the ports were installed successfully.

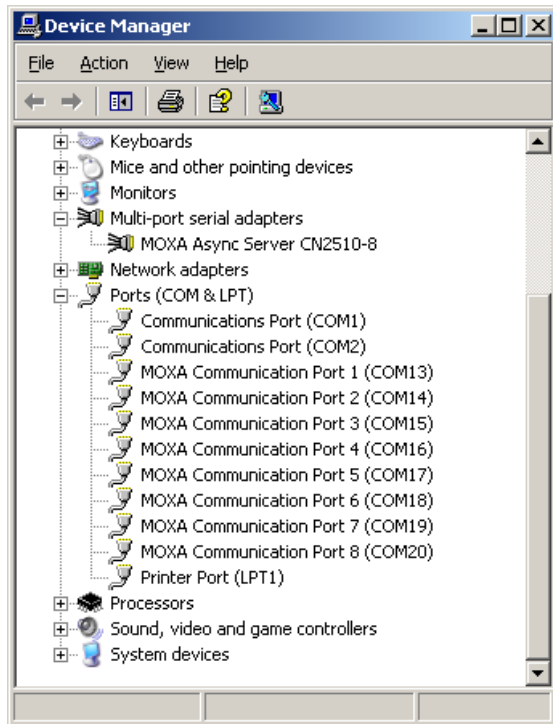

Configuring CN2510 in a Windows XP/2003 Environment

After the CN2510 driver is installed, you will be given the option to proceed directly with the configuration of CN2510. You may also configure CN2510 at a later time. In this section we explain how to configure Real COM Mapping.

1. Click on **Device Manager** → **Multiport serial adapters**, right click on the CN2510 you would like to configure, and select **Properties**.

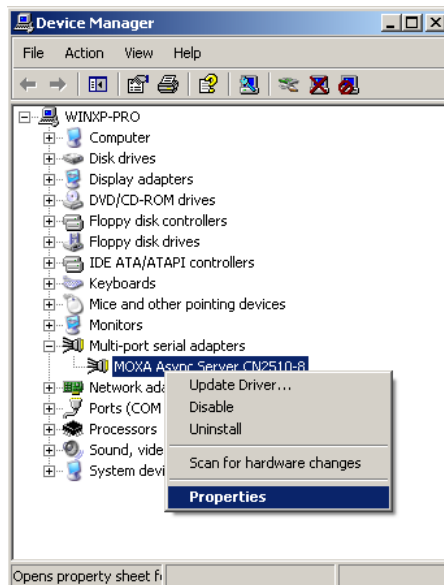

2. Click on the **Configuration** tab.

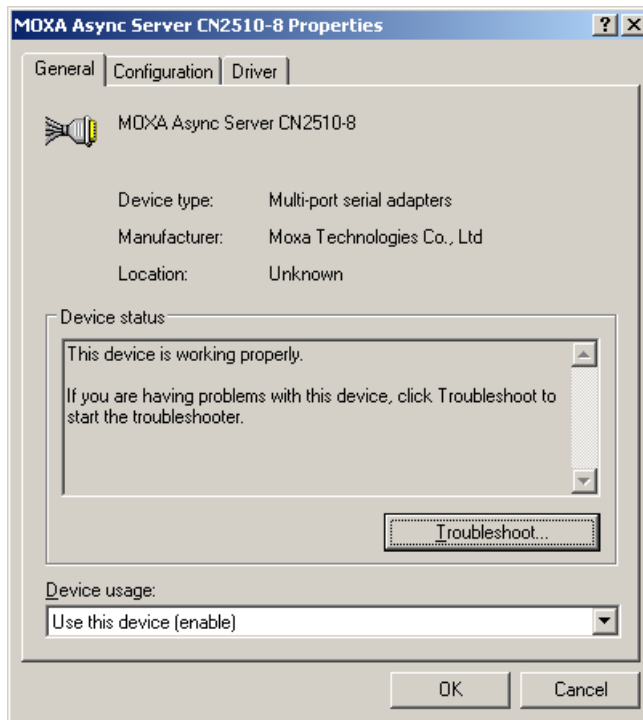

3. Click on **Settings** to configure CN2510's Basic Configuration, Password, and Access Control.

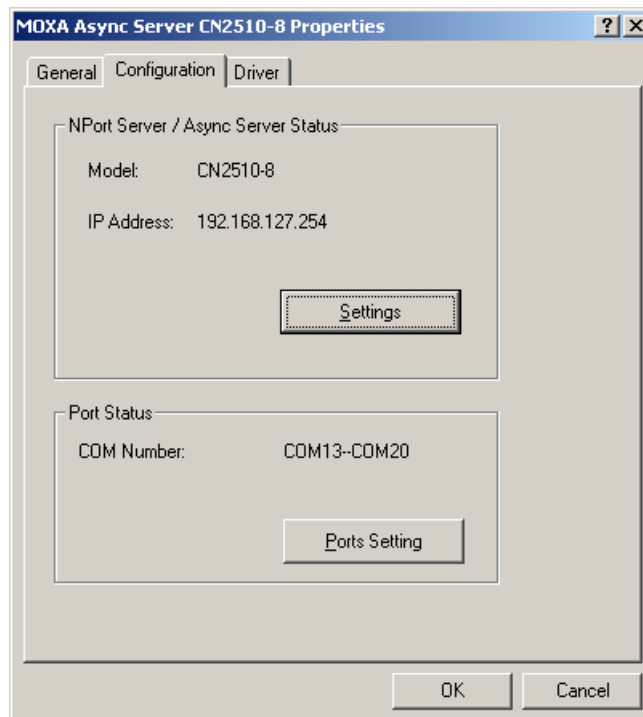

4. On the **Basic Configuration** page, modify **Server Name**, **IP Address**, **Netmask**, and **Gateway**. Check the **DHCP** checkbox if the network parameters will be assigned automatically by a DHCP server.

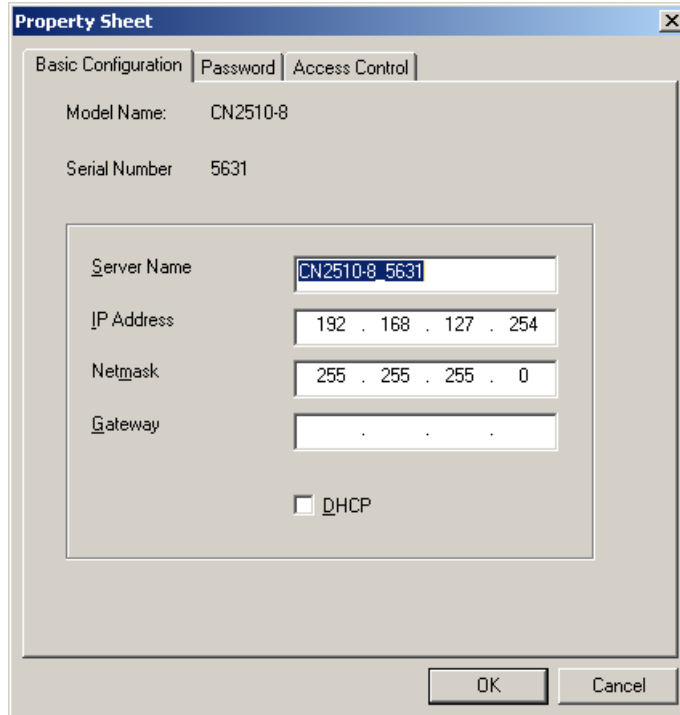

5. On the Password page, add a password or change the existing password. Check the **Remember Password** checkbox to remember the password on this computer.

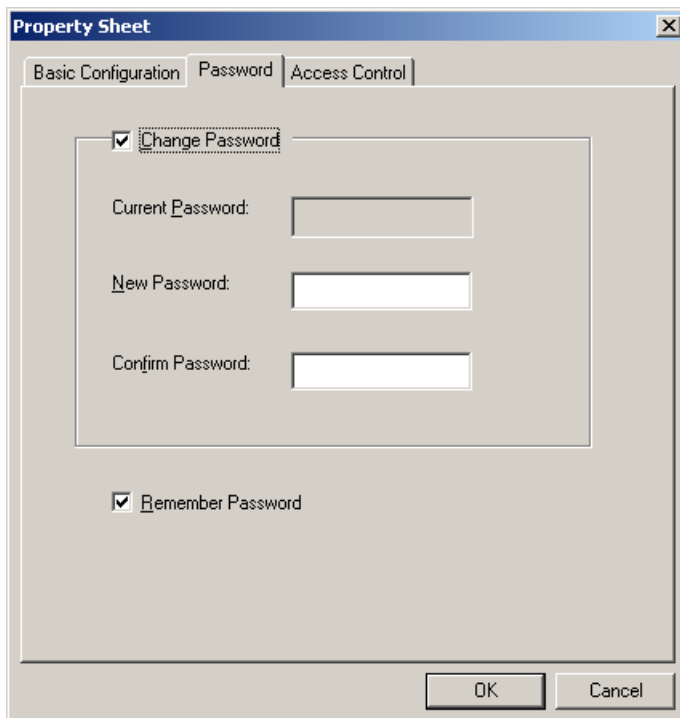

- 6. The **Access Control** page allows you to set up access rights for each of the CN2510's ports. Access right is assigned by IP address. In the example shown here, the "netmask" of 255.255.255.255 limits access to the listed IP address (192.168.6.16). To allow access to a group of IP addresses, adjust the "netmask" accordingly.

To allow *any* IP address to access a port, delete all IP addresses assigned to that port.

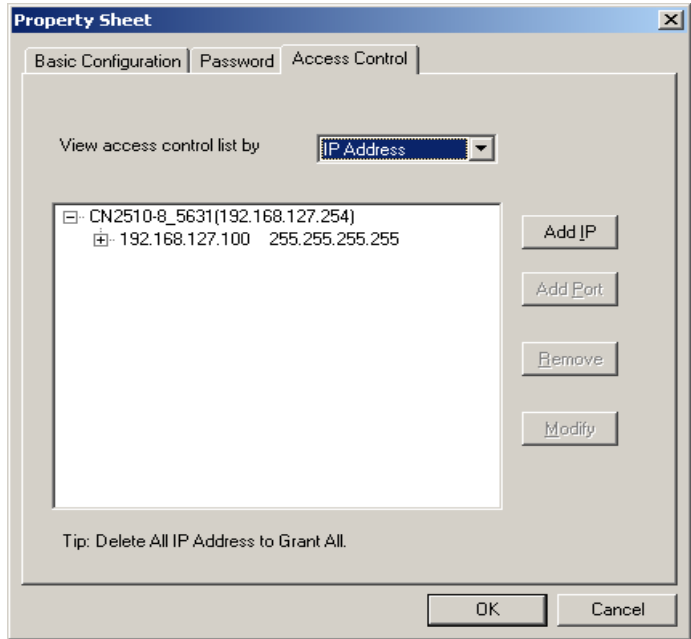

- 7. Click on **Modify** to save all **Property Sheet** settings and return to the **Properties / Configuration** page.

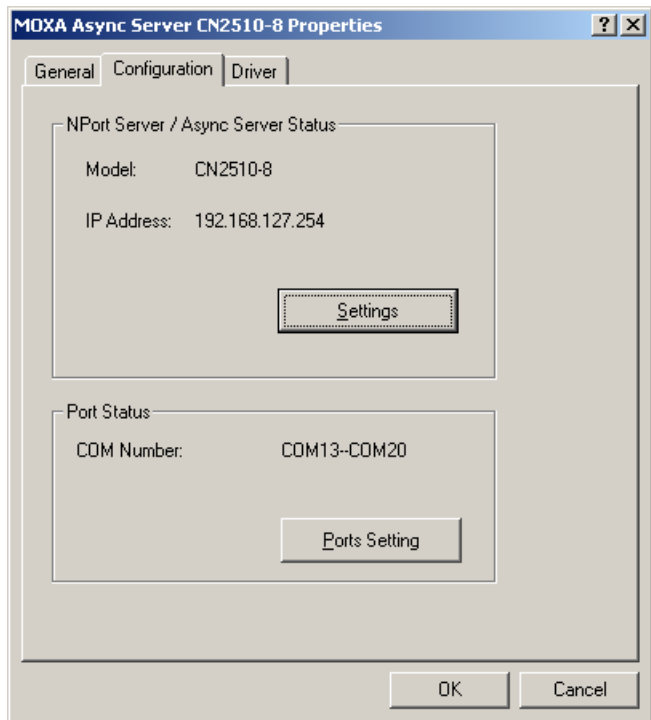

- Click on **Ports Setting** to configure the data transmission mode and FIFO for each COM port.

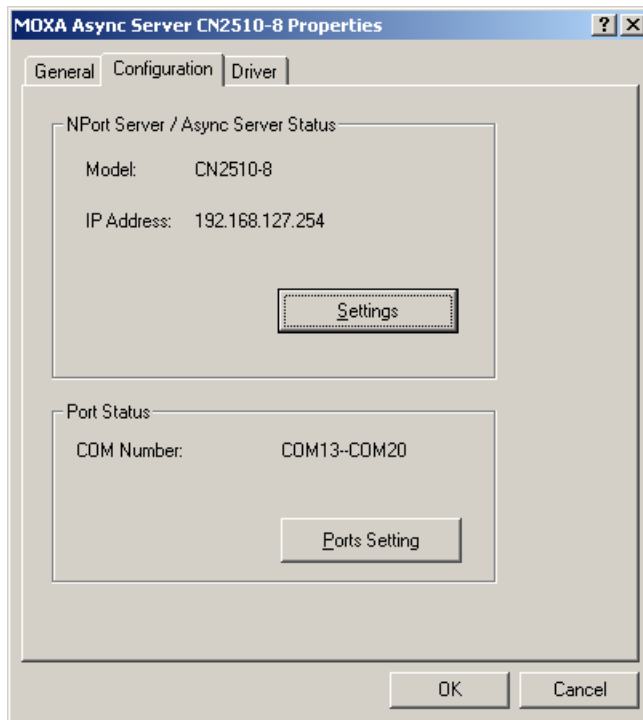

- Check the box(es) next to the port(s) you would like to modify, and then click on **Modify Setting**.

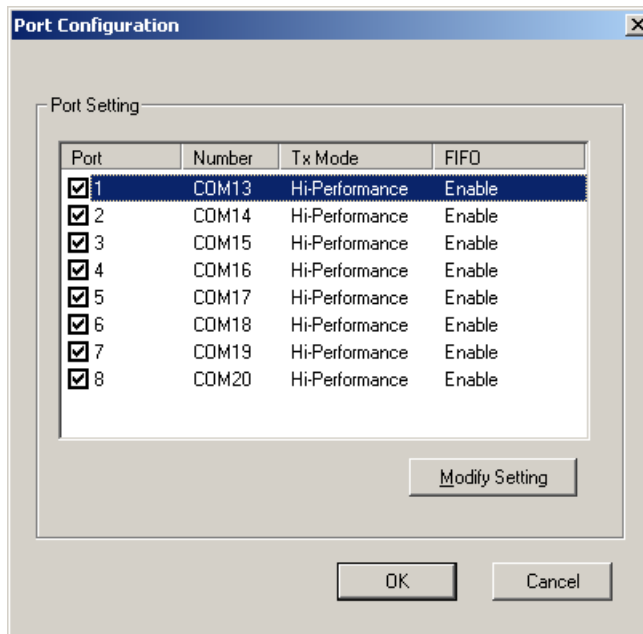

10. Modify the settings that need to be changed, and then click on **OK**.

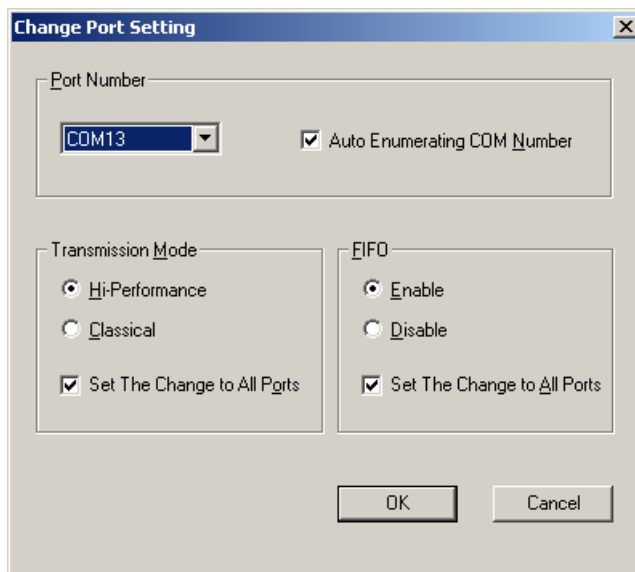

Setting up Windows 2000 Hosts

In this section, we explain how to set up a host in a Windows 2000 environment.

Installing a Server

1. Unzip the Windows 2000 driver file, located on the CN2510 CD ROM, to your hard disk.
2. Run the Windows **Add Hardware Wizard**, located in the **Control Panel**.



- When the **Welcome to the Add Hardware Wizard** window opens, click on **Next** to continue.



- In the **Choose a Hardware Task** window, select **Add/Troubleshoot a device**, and then click on **Next** to continue.

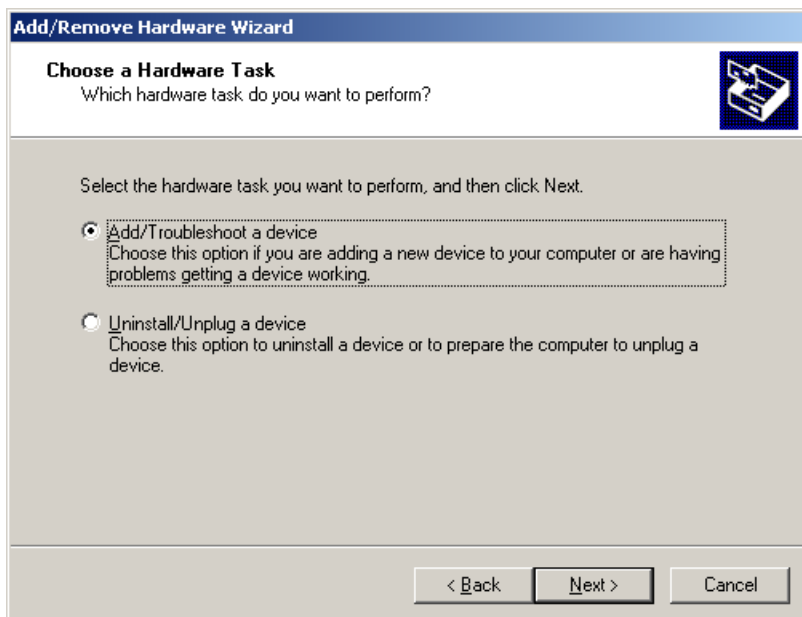

- In the **Choose a Hardware Device** window, select **Add a new device**, and then click on **Next** to continue.

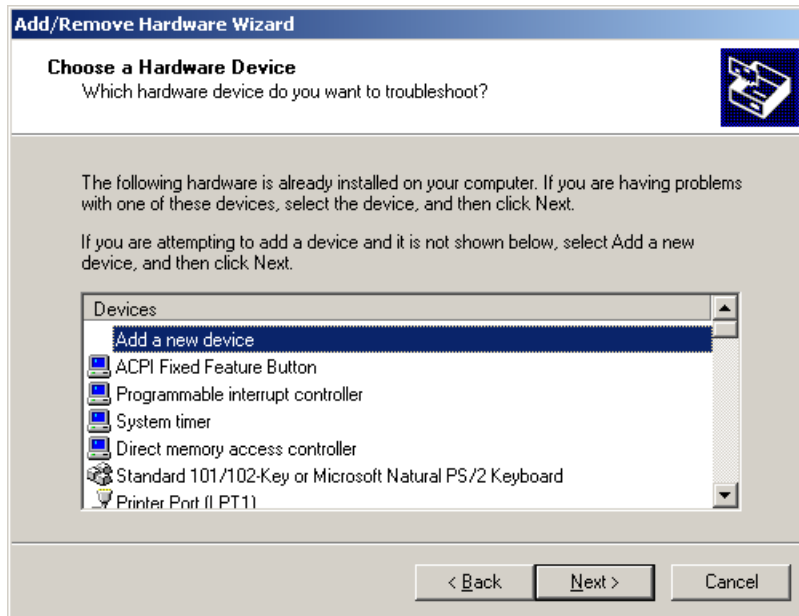

- In the **Find New Hardware** window, select **No, I want to select the hardware from a list**, and then click on **Next** to continue.

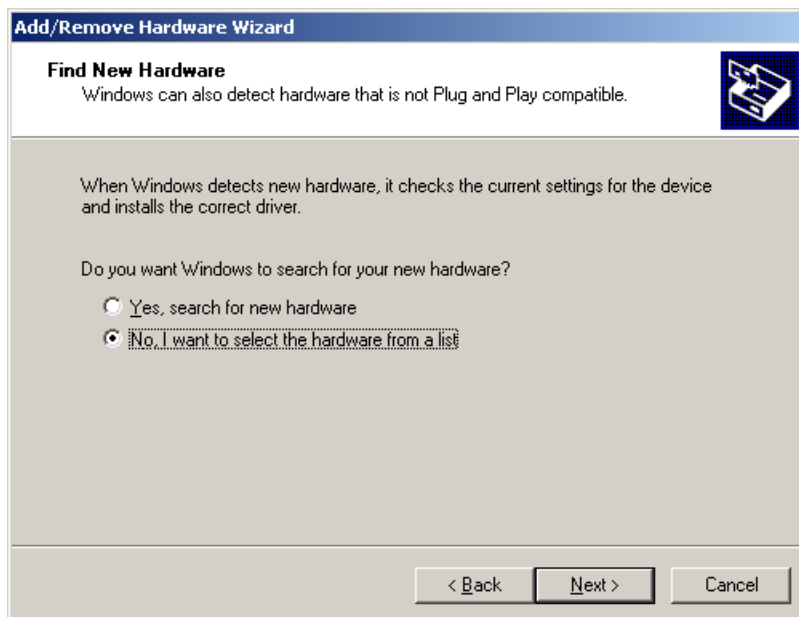

- In the **Hardware Type** window, select **Multi-port serial adapters** from the **Hardware types** list, and then click on **Next** to continue.

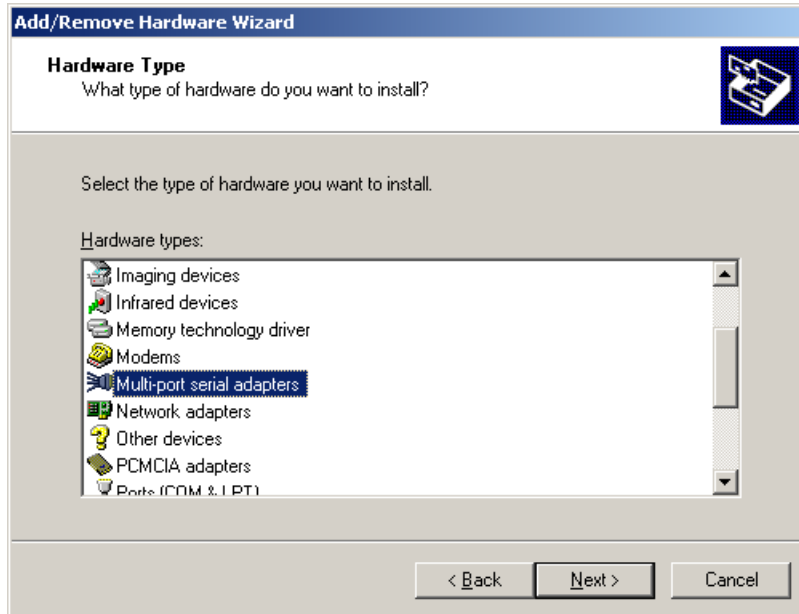

- Click on **Have Disk** to install from the CD, and then click on **Next** to continue.

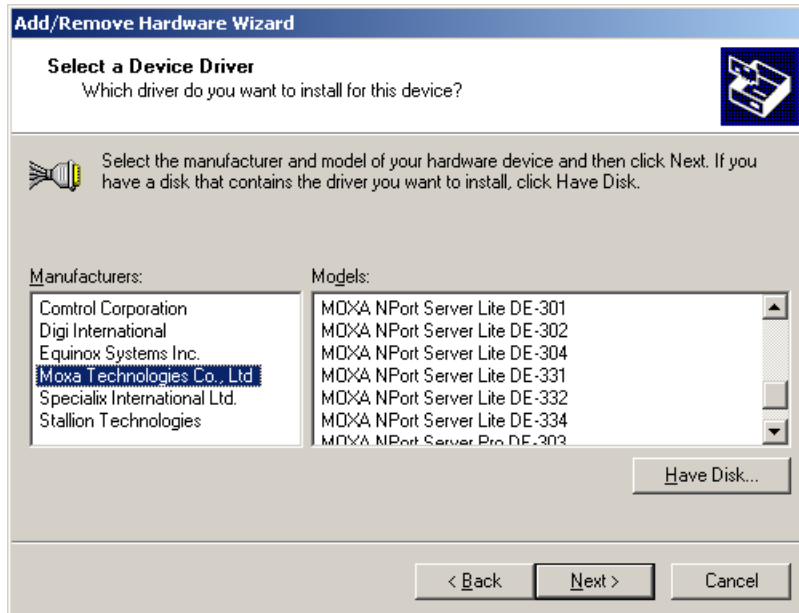

9. After locating the **win2k** folder, select the driver file **NPSEVER.INF**, and then click on **Open**.

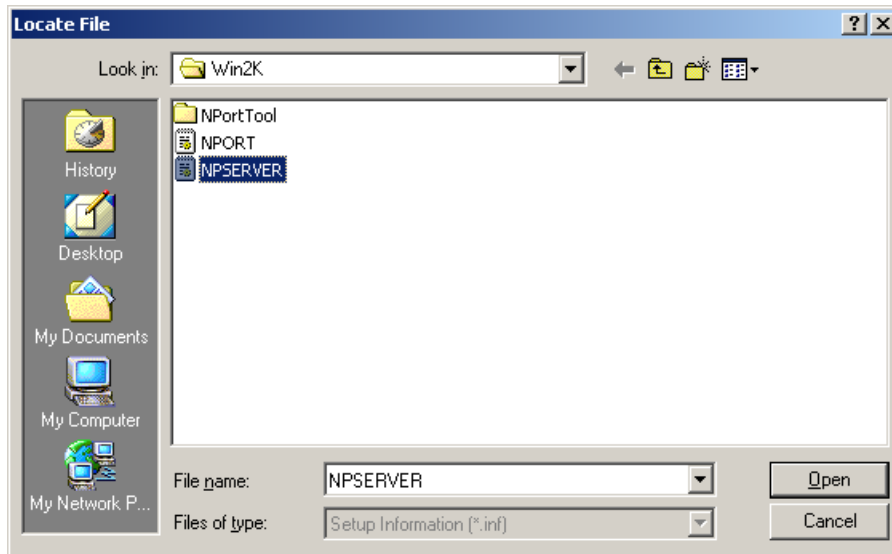

10. Select the correct CN2510 model, and then click on **Next** to continue.

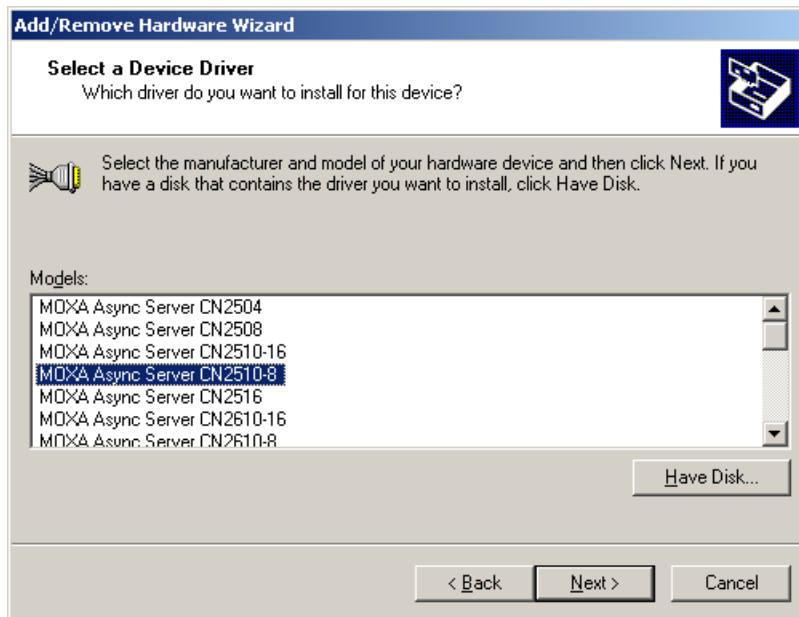

11. The Wizard will start installing the Server driver, and automatically search the network for copies of the CN2510 model you selected in the previous step.

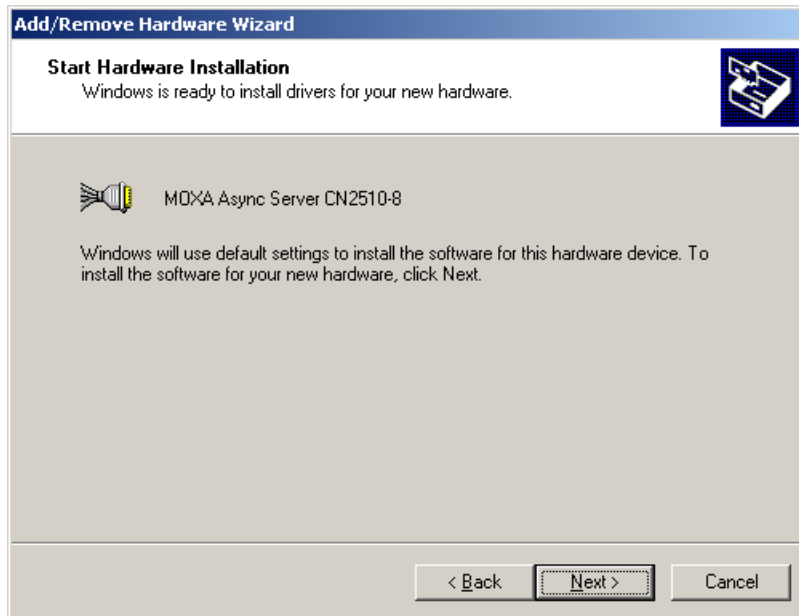

12. Although the next window to open states that the software hasn't passed Windows Logo testing, you can rest assured that this driver has already been tested and been shown that it can support this Windows OS. Click on **Continue Anyway** to proceed.

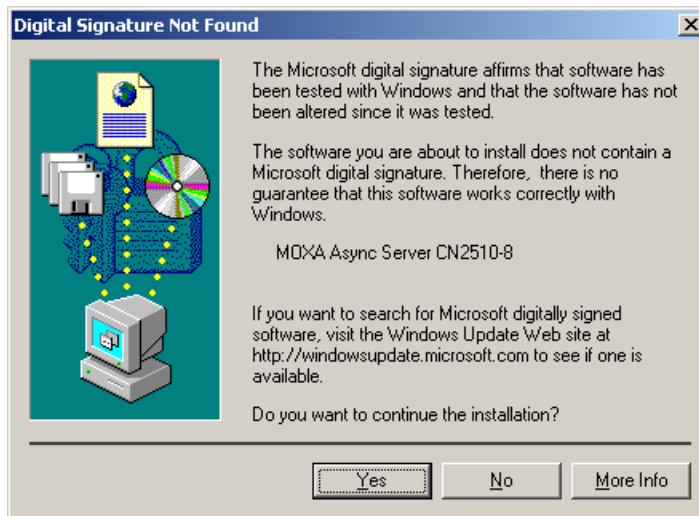

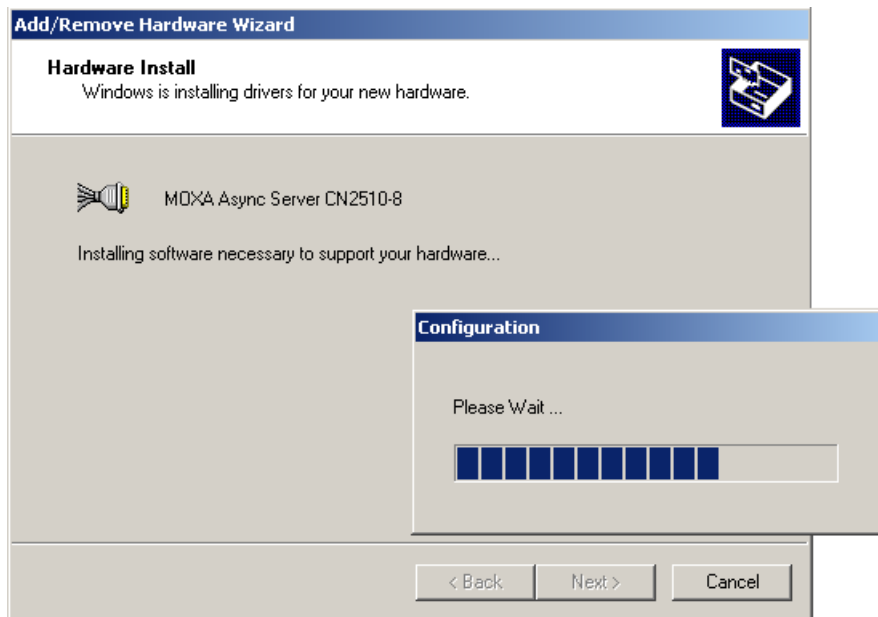

13. You can select the CN2510 that was located automatically, or select **Manually Enter the IP address of NPort Server / Async Server** and then enter the IP address of a different server. Click on **Next** to finish installing CN2510 driver.

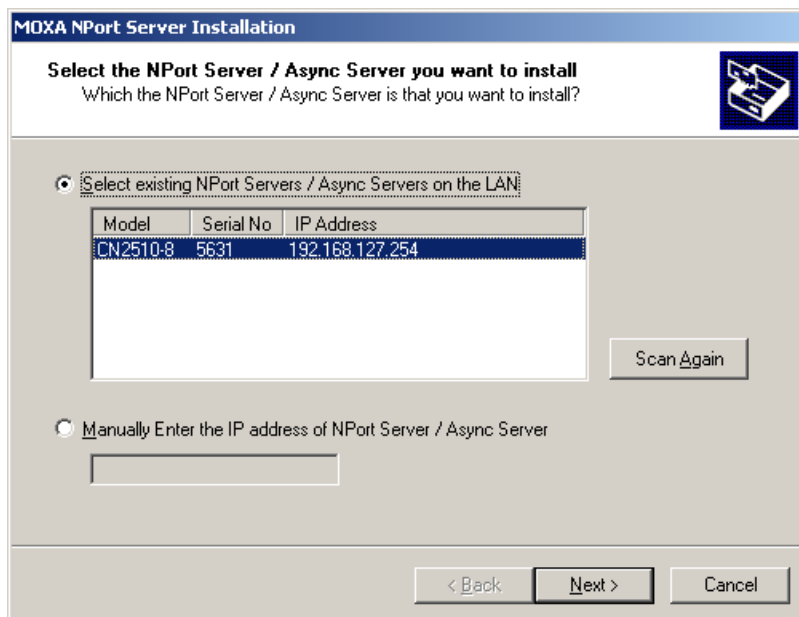

- The next window reports that the driver was installed, and port drivers will be installed next. Click on **Next** to continue.

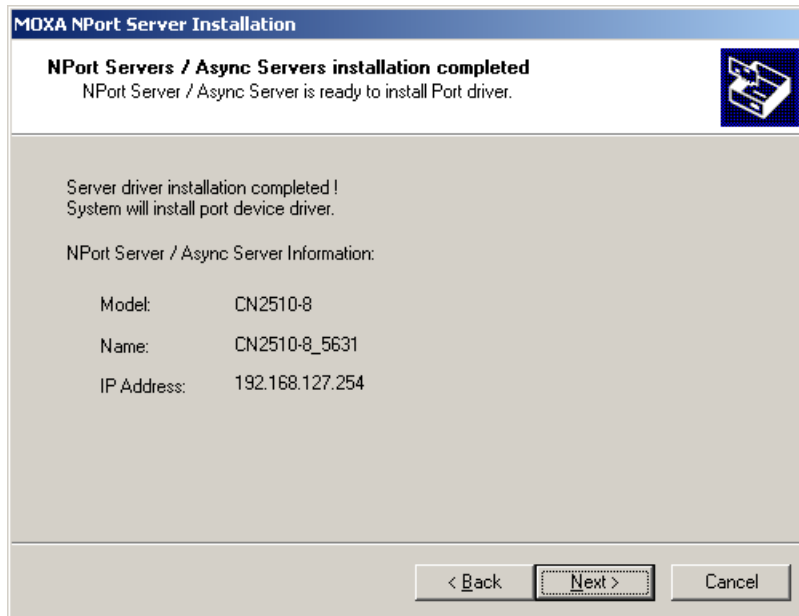

Installing Ports

- The ports will be installed automatically. Click on **Finish** to conclude the installation procedure.

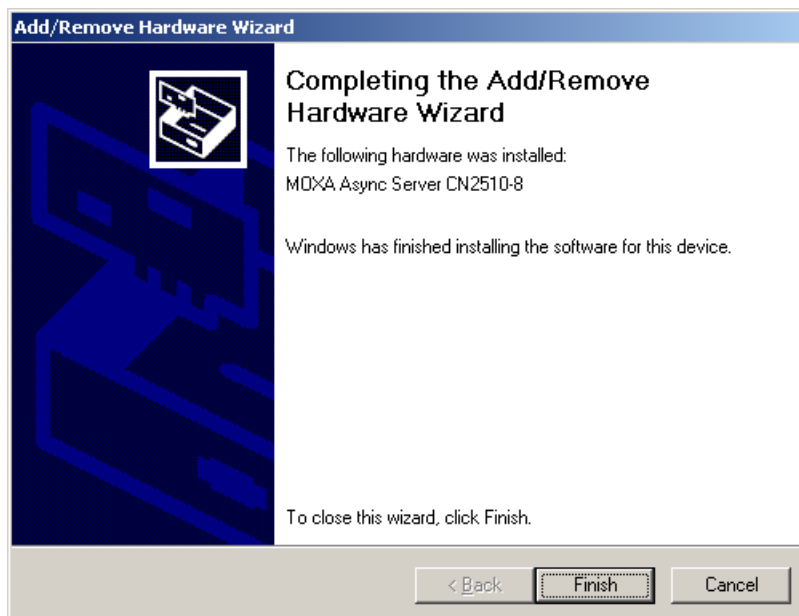

2. After the installation is complete, you can check **Ports (COM & LPT)** under **Device Manager** to verify that all of the ports were installed successfully.

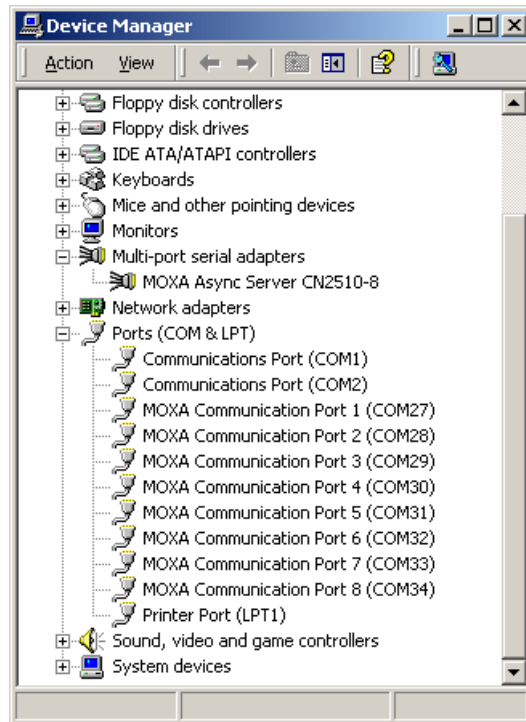

Configuring CN2510 in a Windows 2000 Environment

After the CN2510 driver is installed, you will be given the option to proceed directly with the configuration of CN2510. You may also configure CN2510 at a later time. In this section we explain how to configure Real COM Mapping.

1. Click on **Device Manager** → **Multiport serial adapters**, right click on the CN2510 you would like to configure, and select **Properties**.

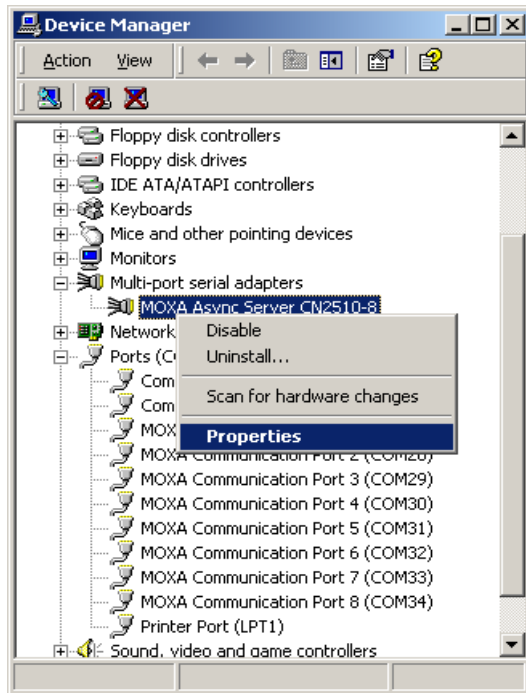

2. Click on the **Configuration** tab.

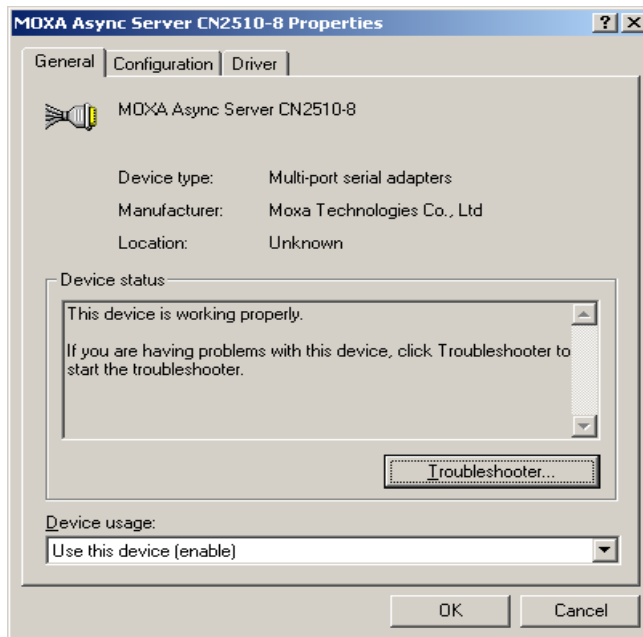

- Click on **Settings** to configure CN2510's Basic Configuration, Password, and Access Control.

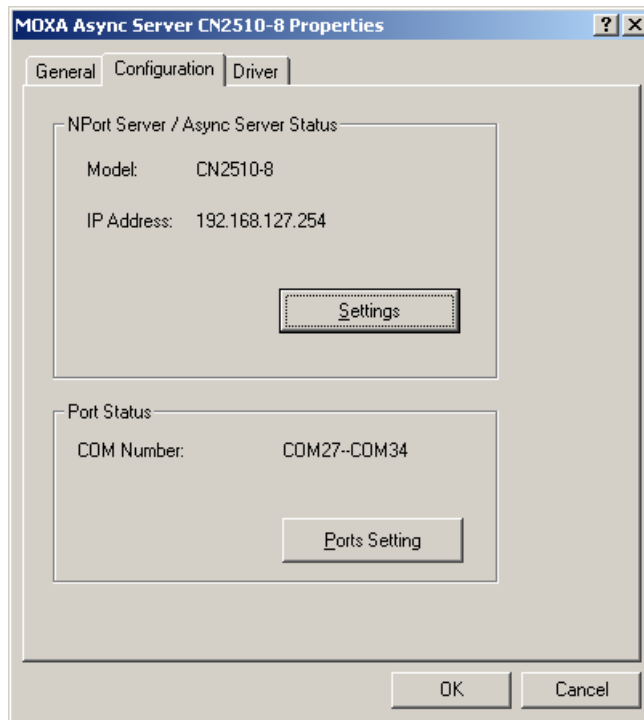

- On the **Basic Configuration** page, modify **Server Name**, **IP Address**, **Netmask**, and **Gateway**. Check the **DHCP** checkbox if the network parameters are assigned automatically by a DHCP server.

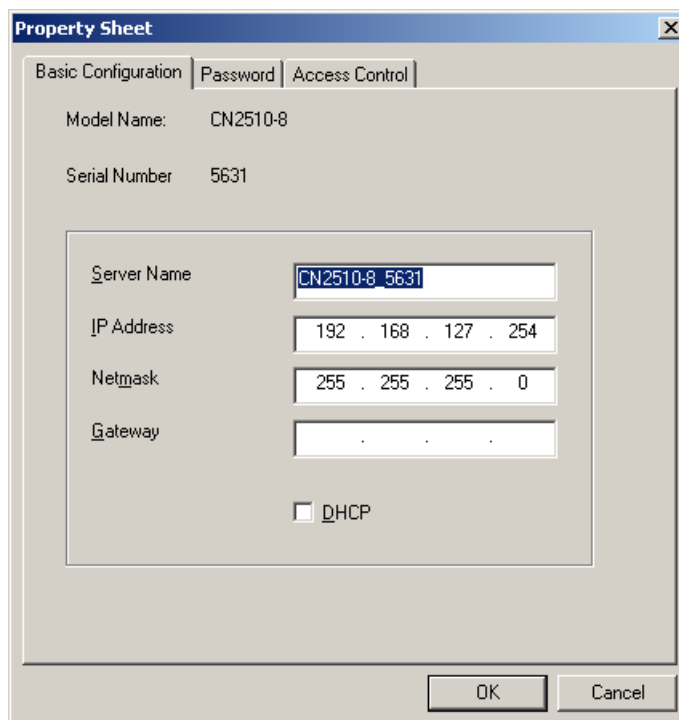

- On the Password page, add a password or change the existing password. Check the **Remember Password** checkbox to remember the password on this computer.

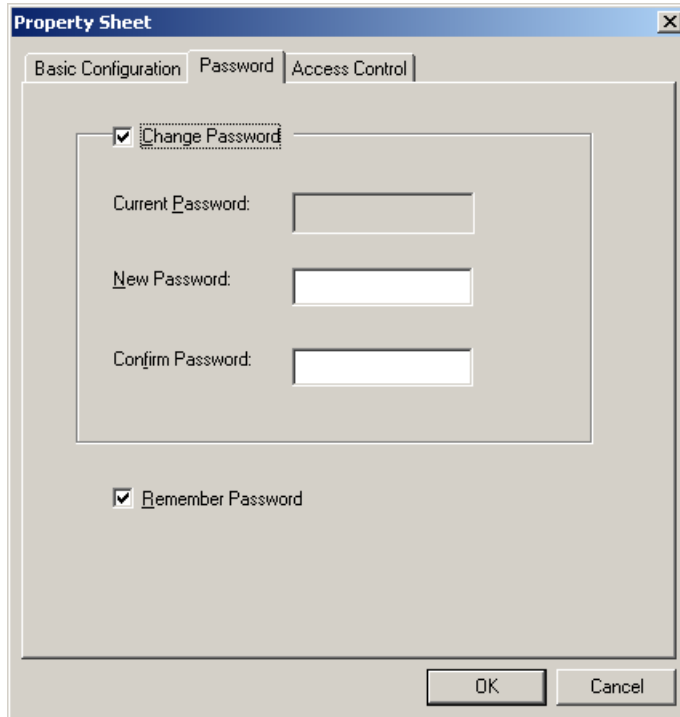

- The **Access Control** page allows you to set up access rights for each of the CN2510's ports. Access right is assigned by IP address. In the example shown here, the "netmask" of 255.255.255.255 limits access to the listed IP address (192.168.6.16). To allow access to a group of IP addresses, adjust the "netmask" accordingly. To allow *any* IP address to access a port, delete all IP addresses assigned to that port. Click on **Modify** to make changes.

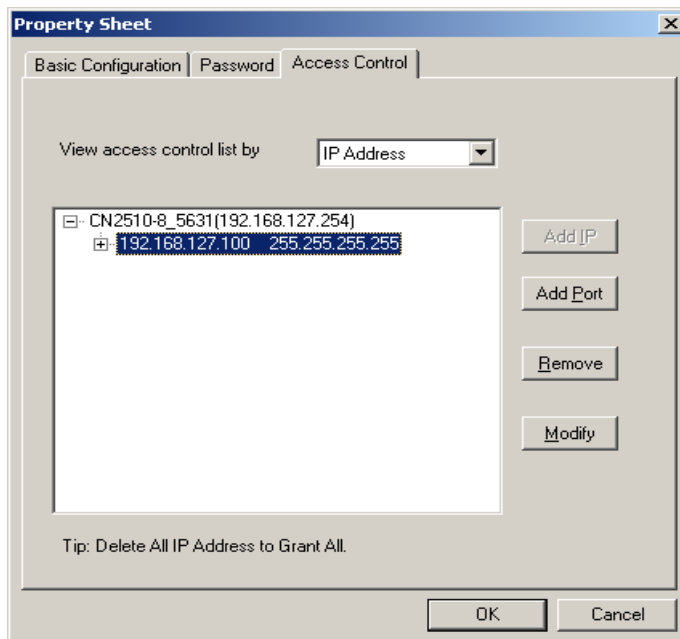

- And then click on **OK** to return to the **Access Control** page.

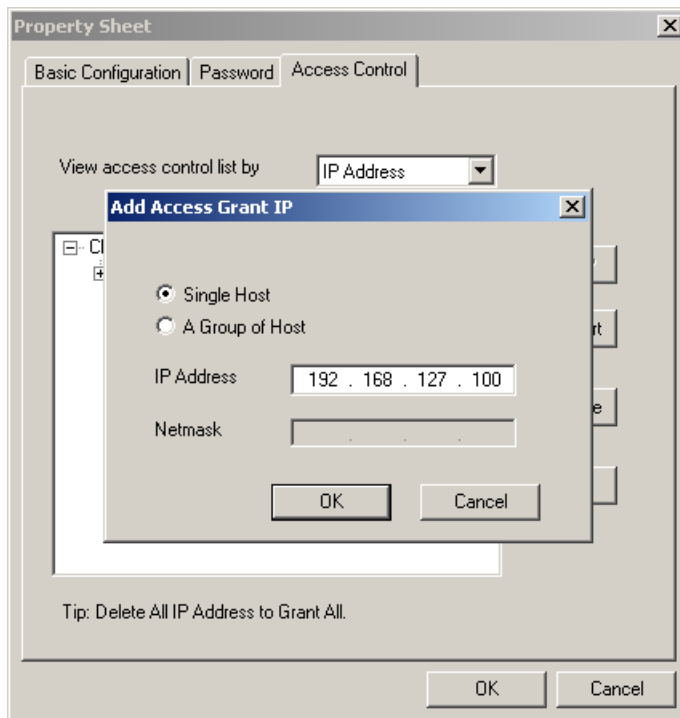

- Click on **OK** to return to the Configuration page.

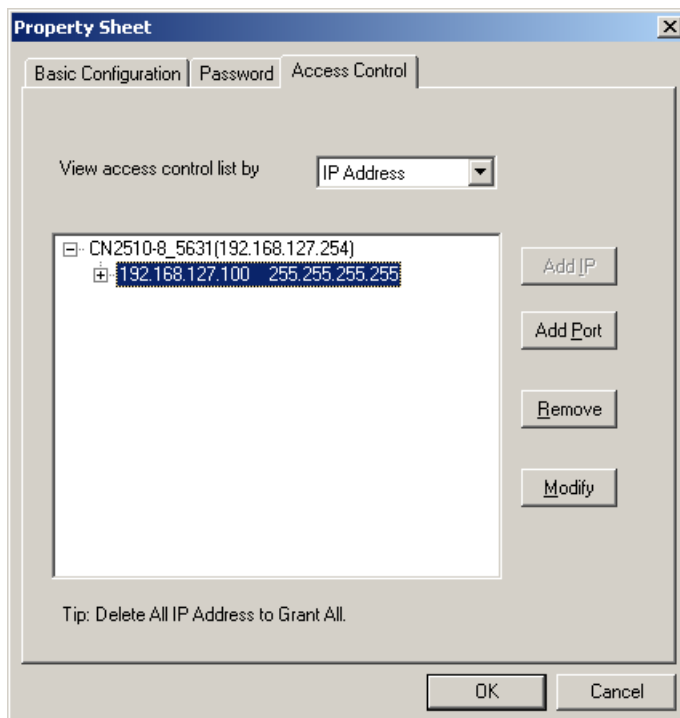

9. Click on **Ports Setting** to configure the data transmission mode and FIFO for each COM port.

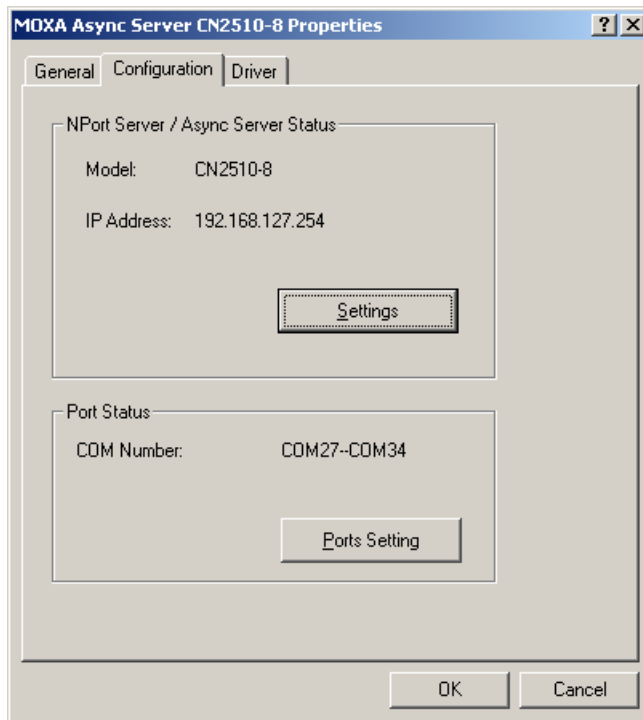

10. Check the box(es) next to the port(s) you would like to modify, and then click on **Modify Setting**.

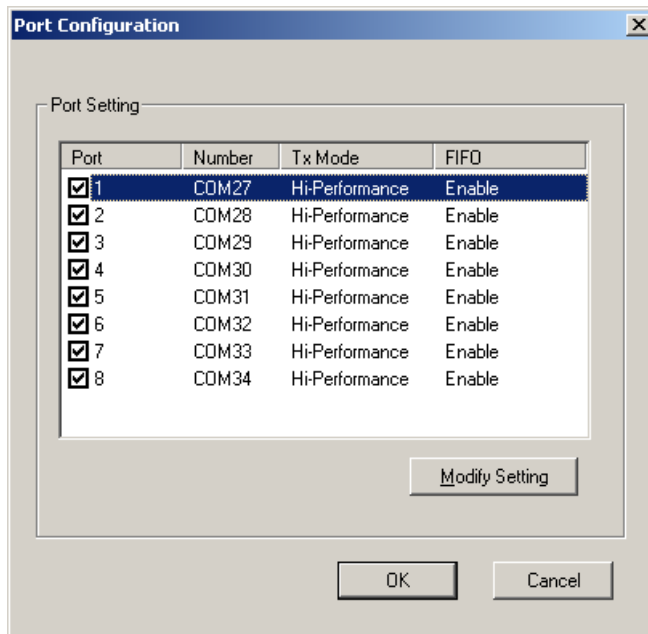

11. Modify the settings that need to be changed, and then click on **OK**.

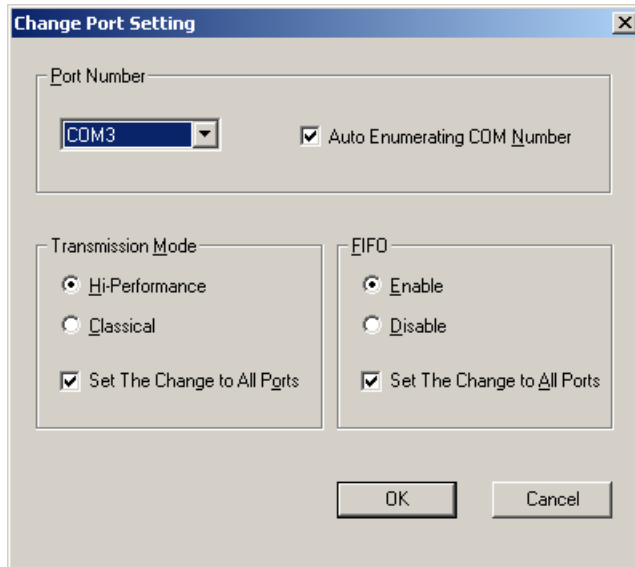

Setting up Windows 95/98/ME/NT Hosts

In this section, we explain how to set up a host in a Windows 95/98/ME/NT environment. You will first install the **NPort Pro Manager** program, and then use this utility to configure the server. We use Windows NT to illustrate the installation procedure.

Installing a Server

1. Unzip the Windows 95/98/ME/NT driver file, located on the CN2510 CD ROM, to your hard disk.
2. Locate and run the **Setup.exe** file.

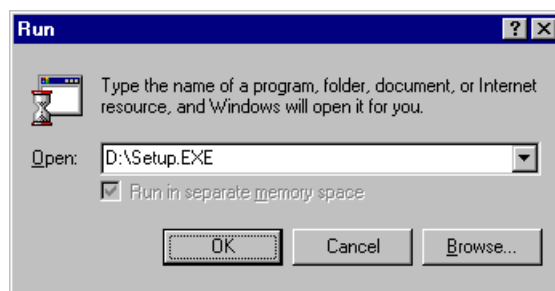

- The setup program is used for both CN2500 and NPort Server Pro products, so you will see a **Welcome to NPort Server Pro** window. Click on **Next** to continue.

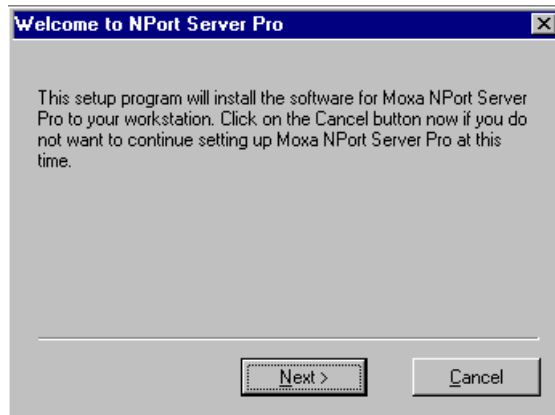

- Select **Custom** mode, and then click on **Next** to continue.

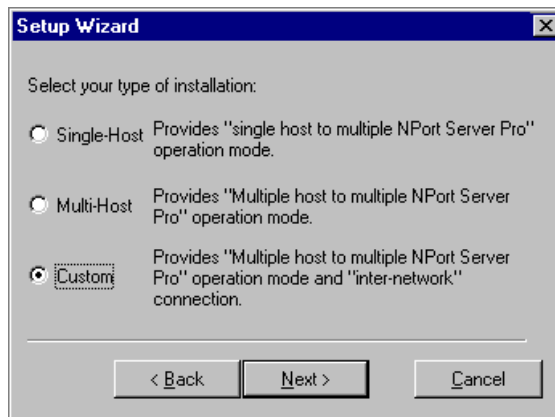

- Select a **Destination Directory** and then click on **Next** to continue.

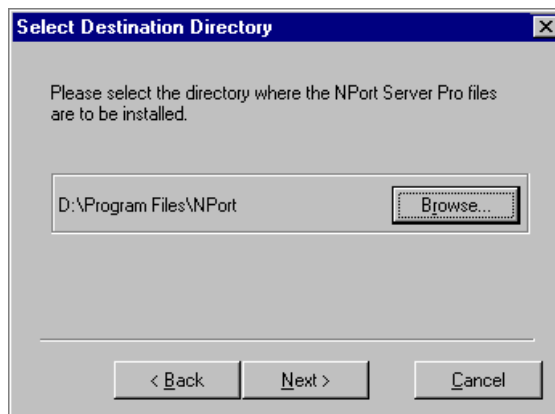

- Click on **Next** to finish installing NPort Pro Manager.

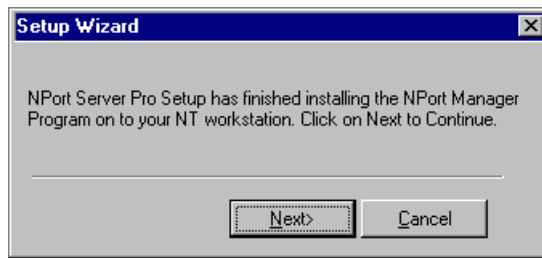

- After the driver is installed, **NPort Pro Manager** and the **Add Server Wizard** will start running automatically. Select **Yes**, and then click on **Next** to continue.

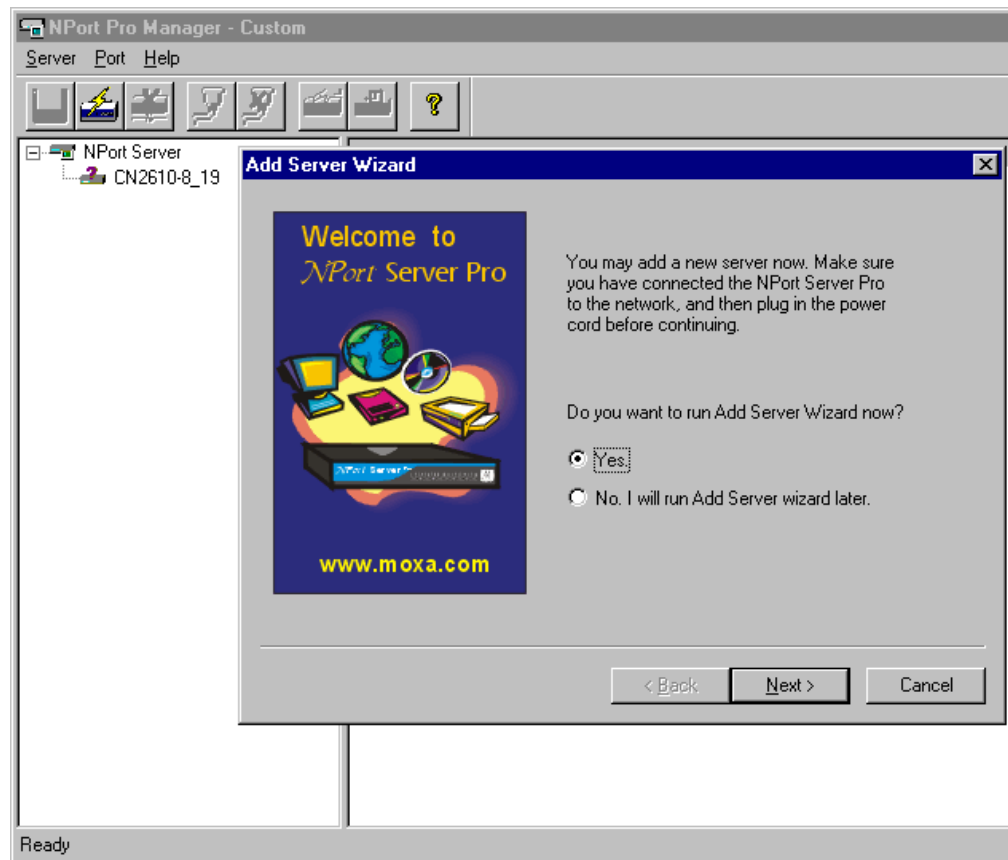

8. Select one of the server's in the list, or select **No, I will define the server myself** if the correct server is not listed. Click on **Next** to continue.

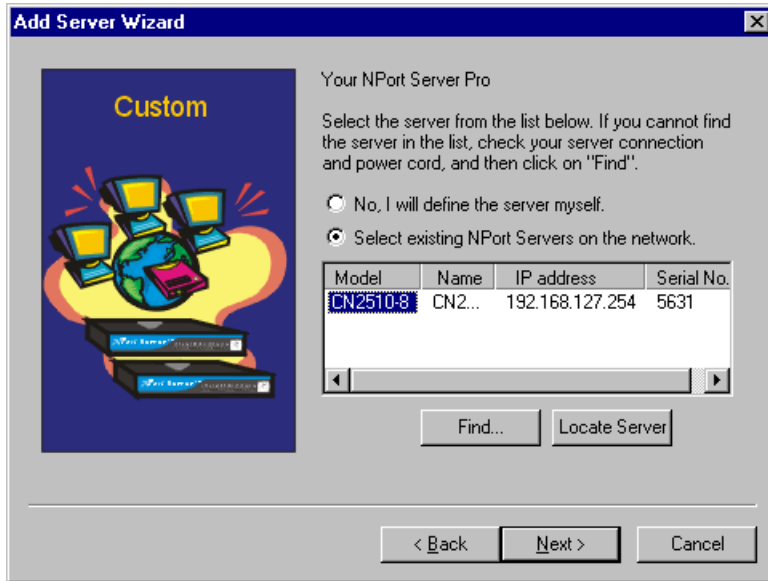

9. If necessary, enter a different IP address in the **Server IP address** box, and then click on **Next** to continue.

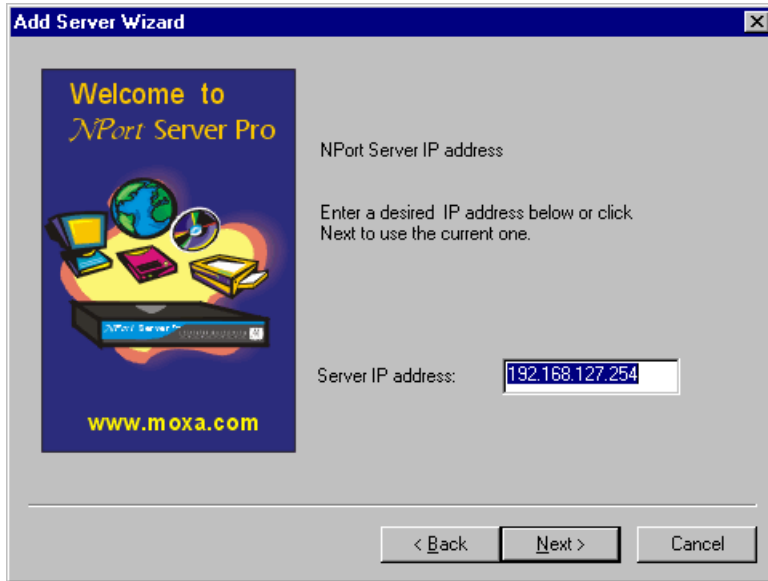

10. Select the COM number for CN2510's port 1. The rest of the ports will be mapped automatically. Click on **Next** to continue.

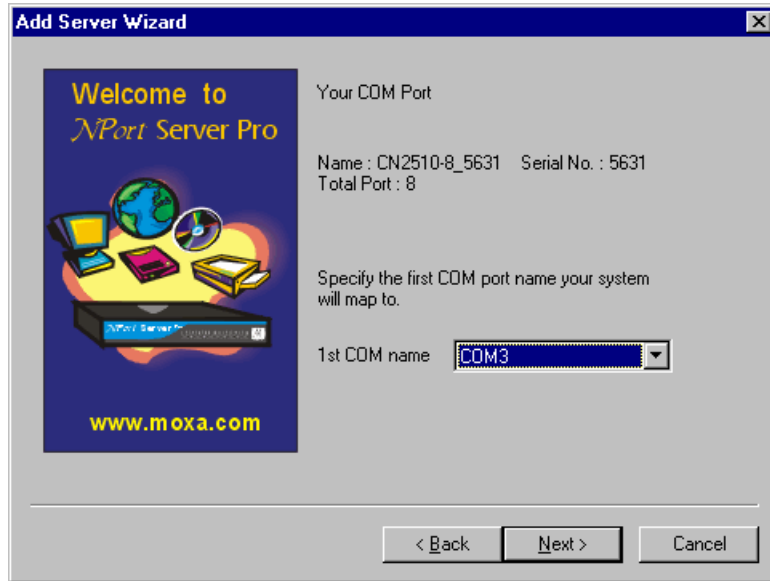

11. For added security, set a password for the CN2510. Check the **Auto-Saved** box to save the password on your computer. Click on **Next** to continue.



12. Check the new server settings to make sure they are correct, and then click on **Finish**.

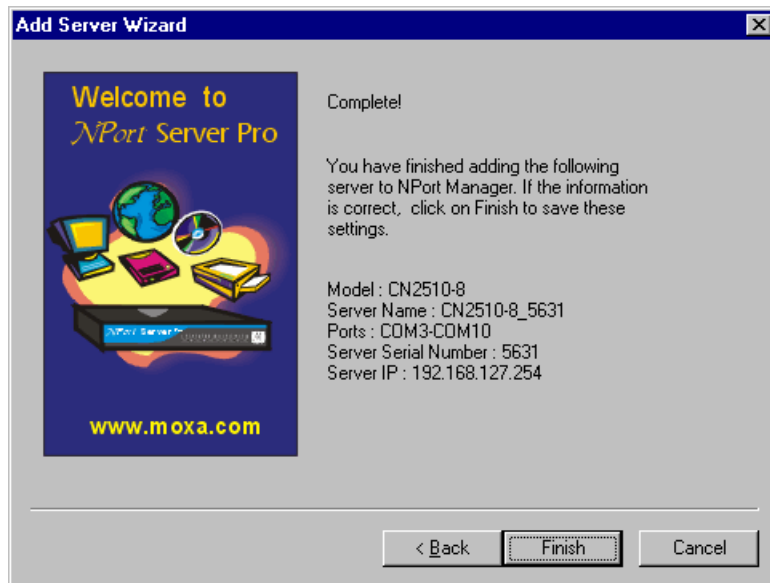

13. The server and ports will be displayed in the **NPort Server Manager** window. Click the **Save** icon in the upper left corner to save the settings before exiting the program.

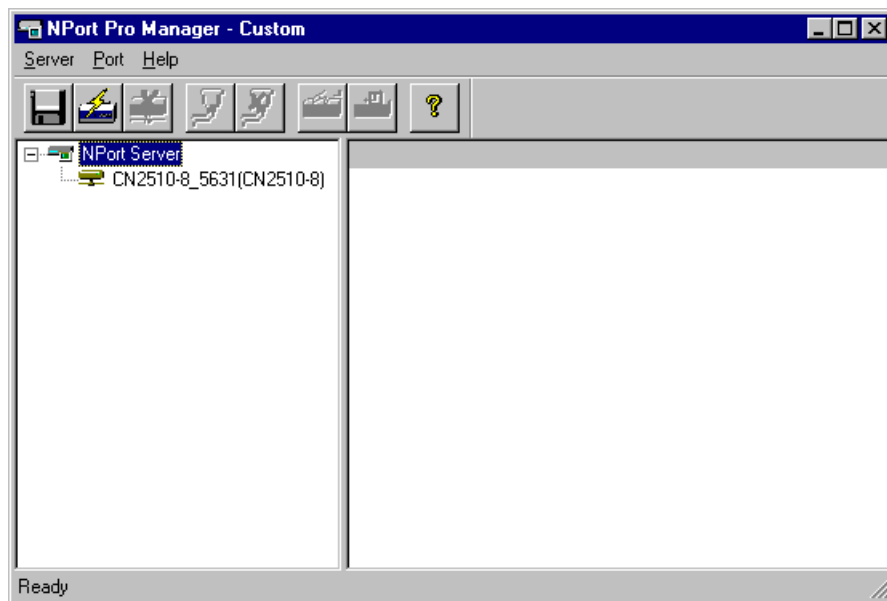

Configuring CN2510 in a Windows 95/98/ME/NT Environment

After the CN2510 driver is installed, you can proceed directly with the configuration of CN2510, or configure CN2510 at a later time. In this section we explain how to configure Real COM Mapping.

1. Start the Manger by clicking on **Start → Properties → NPort Server → NPort Server Manager**, and then click on the server you would like to configure. The ports will be shown in the right pane of the window.

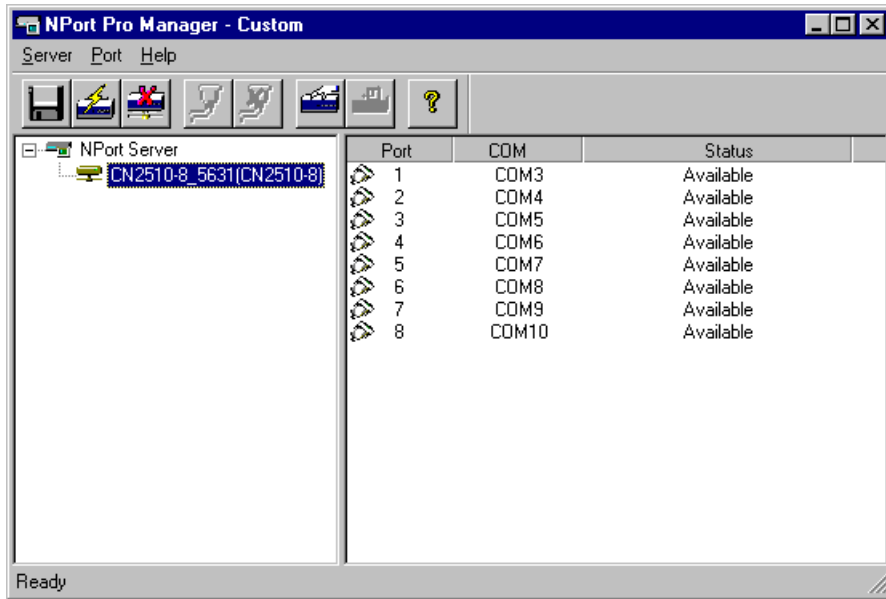

2. Right click on the CN2510 you wish to configure, click the right mouse button, and then select **Server Properties**.

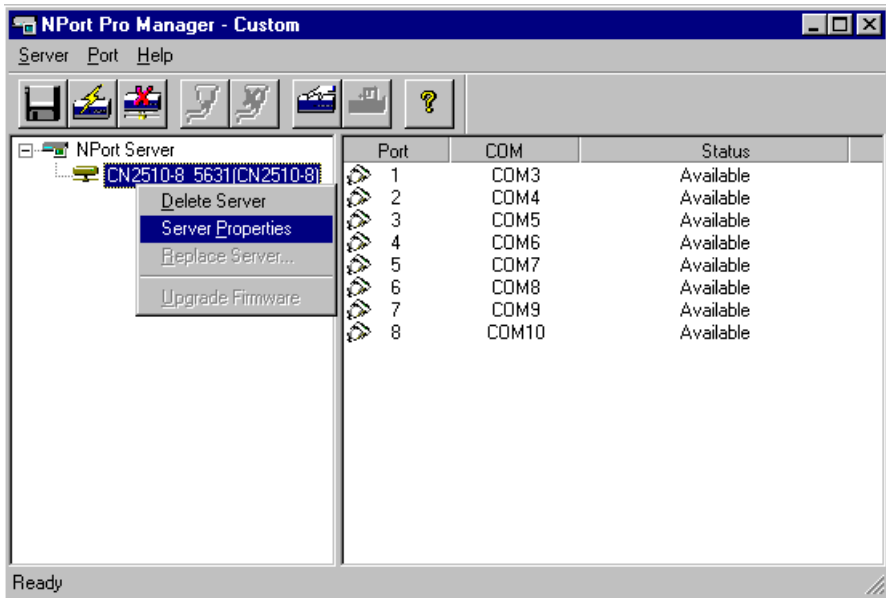

- On the **General** page, you can see the server's **Serial No.**, and modify **Server Name**, **Server IP**, and **Netmask**. Select the **Enable** option (to the right of DHCP) if the network parameters are assigned automatically by a DHCP server.

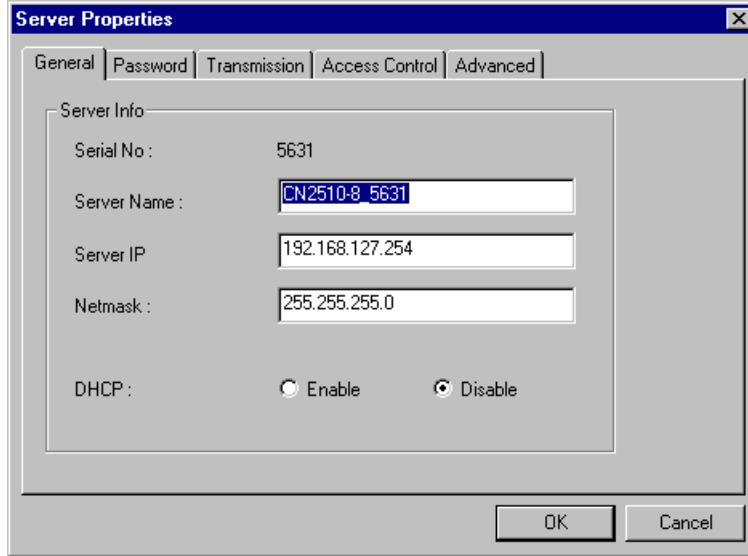

- On the **Password** page, set up a password for this CN2510 for added security. Check the **Auto Save Password on this computer** box if you want your computer to remember the password.

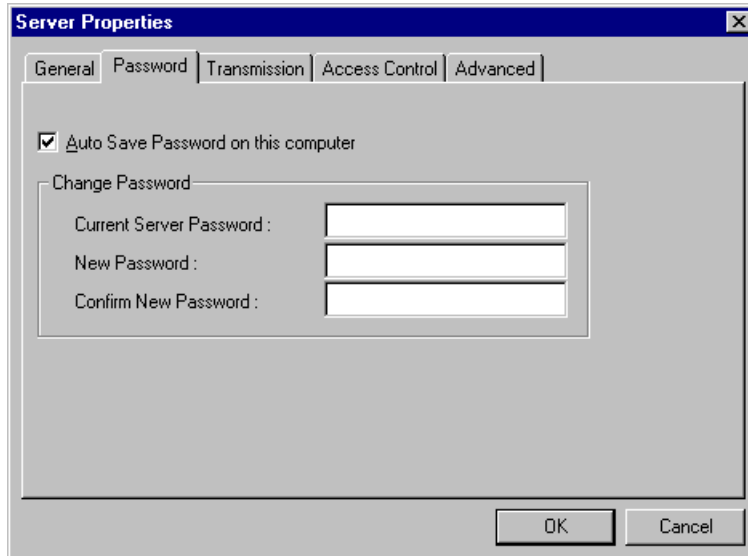

- The **Access Control** page allows you to set up access rights for each of the CN2510's ports. Access right is assigned by IP address.

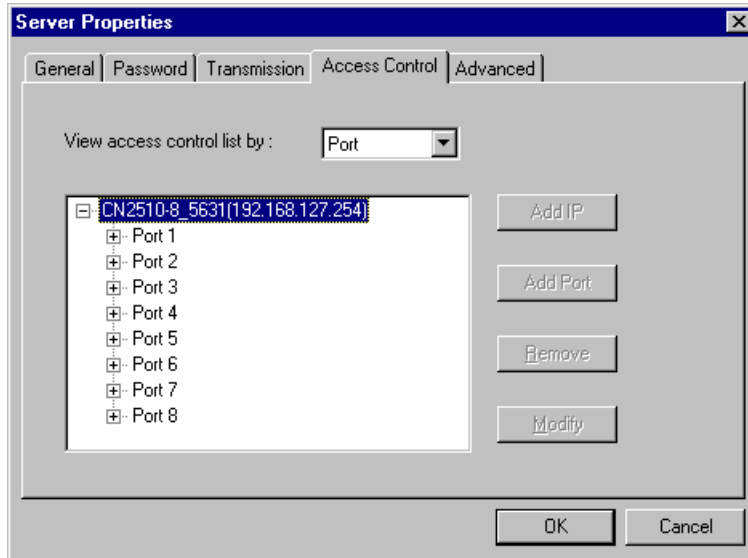

- The **Transmission** page lets you to select a **Transmission Mode** and **Tx FIFO** for each port.

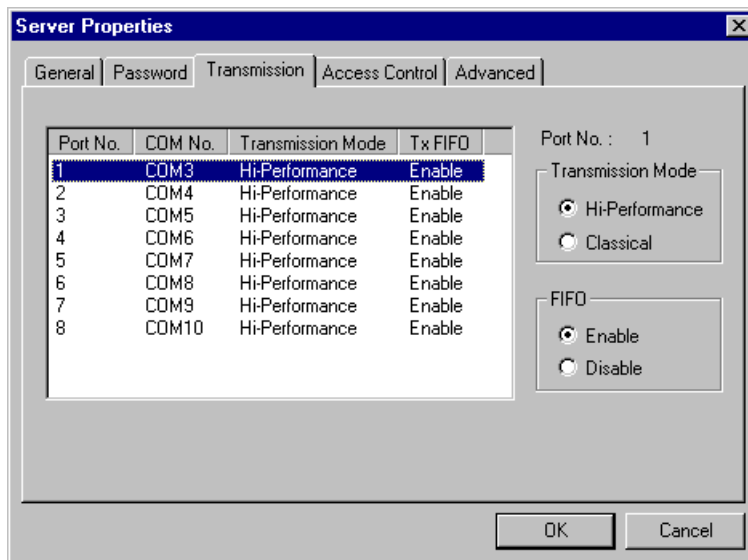

- The **Access Control** page is used to modify access rights to the server.

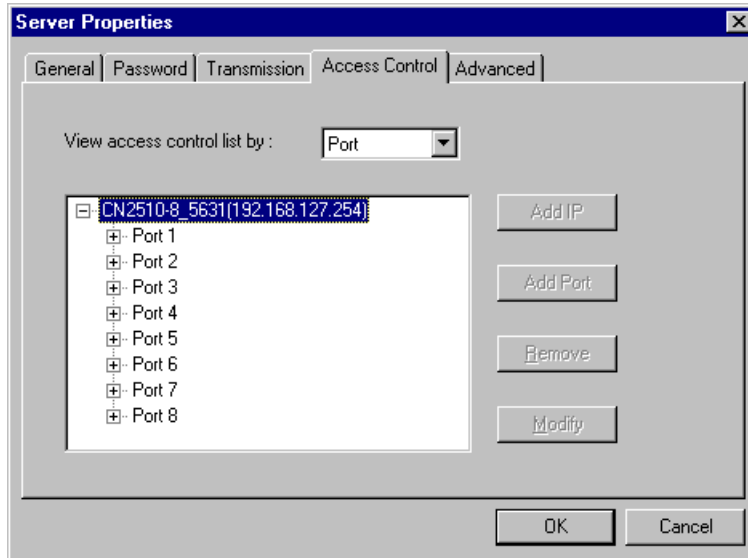

- The **Advanced** page allows you to add routes to CN2510. However, since CN2510 has a column to set the Default Gateway, you can ignore this configuration.

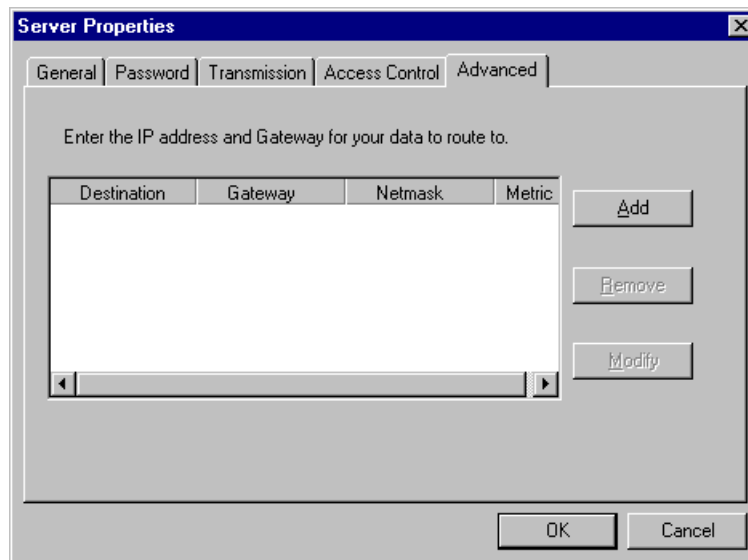

Setting Up Device Control

Device Control applications use standard Linux/Unix Socket programming for Linux/Unix systems, or WinSock programming for Windows systems, to control device data transmission directly. With CN2510 configured for RAW mode, you can focus on pure data transmission, without using serial port control or serial modem control signals. You can also use ASPP mode, provided exclusively by Moxa, to communicate with CN2510.

For both Linux/Unix Socket programming and Windows WinSock programming, IP is used to communicate between hosts and devices. At the end of the chapter, we give examples that explain how ASPP is used in a UNIX/Windows environment.

The following topics are covered in this chapter:

- Accessing the Console Utility**
- Selecting the Application**
- Configuring ASPP Mode**
- Configuring RAW Mode**
- Configuring the Serial Ports**
- Save**
- Restart**
- ASPP Library Introduction**
- ASPP Examples for Unix**
- ASPP Examples for Windows**

Accessing the Console Utility

NOTE In this section, we show how to access CN2510's console utility by Telnet over the network. For information on using the console port, see the section "Accessing the Console Utility" in Chapter 2.

1. Telnet over the network to the server's IP address.

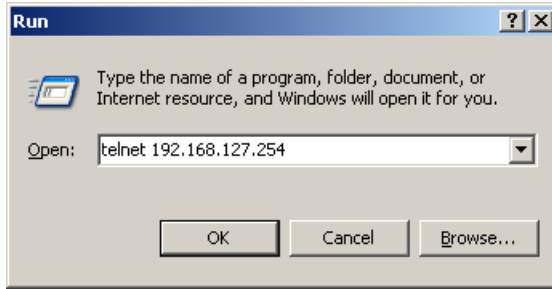

2. Type **1** to choose **ansi/vt100**, and then press **Enter**.

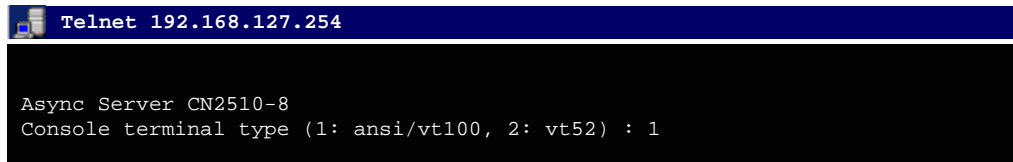

3. CN2510's **MAIN MENU** will open, as shown below.

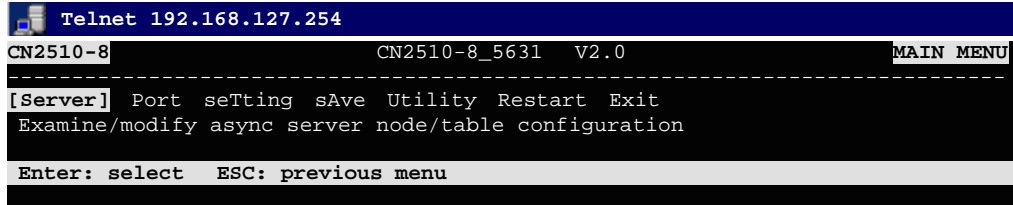

Use the following keystrokes to navigate CN2510's console utility.

Action	Key
Move	[Up/Down/Left/Right] Arrow Key or [Tab] Key
Jump to next menu, or Select item	[Enter] Key
Return to previous menu, or Close pop up selector	[Esc] Key
Shortcut Key	Capitalized letter of the word

Selecting the Application

Open **Port Menu** → **Mode** to configure the **Device Control** application.

- From the **MAIN MENU**, select **Port**, and then press **Enter**.

```

CN2510-8                CN2510-8_5631  V2.0                MAIN MENU
-----
Server [Port] seTting sAve Utility Restart Exit
Examine/modify async server ports configuration
Enter: select  ESC: previous menu
    
```

- From the **PORT MENU**, select **Mode**, and then press **Enter**.

```

CN2510-8                CN2510-8_5631  V2.0                PORT MENU
-----
[Mode] Line mOdem Welcome_MSG Quit
Examine/modify the operation mode of async ports
Enter: select  ESC: previous menu
    
```

- The **Mode** page has pop-up selection lists for **Application**, **Mode**, and **Description/more setting** for each serial port. Use the arrow keys to move the cursor to the **Application** column for the port to be configured, and then press **Enter**. We use Port 6 to illustrate.

```

CN2510-8                CN2510-8_5631  V2.0
-----
[Mode] Line mOdem Welcome_MSG Quit
Examine/modify the operation mode of async ports
ESC: back to menu  Enter: select

Port Application          Mode          Description/more setting
01 [NT Real COM ] [ASPP ] [Async Server Proprietary Protocol]
02 [NT Real COM ] [ASPP ] [Async Server Proprietary Protocol]
03 [NT Real COM ] [ASPP ] [Async Server Proprietary Protocol]
04 [NT Real COM ] [ASPP ] [Async Server Proprietary Protocol]
05 [NT Real COM ] [ASPP ] [Async Server Proprietary Protocol]
06 [NT Real COM ] [ASPP ] [Async Server Proprietary Protocol]
07 [NT Real COM ] [ASPP ] [Async Server Proprietary Protocol]
    
```

- Use the **Up/Down** arrow keys to select **Device Control**, and then press **Enter**.

```

CN2510-8                CN2510-8_5631  V2.0
-----
[Mode] Line mOdem Welcome_MSG Quit
Examine/modify the operation mode of async ports
ESC: back to menu  Enter: select

Port Application          +-----+ption/more setting
01 [NT Real COM ] | Disable | Server Proprietary Protocol]
02 [NT Real COM ] | Dialin/out | Server Proprietary Protocol]
03 [NT Real COM ] | Terminal | Server Proprietary Protocol]
04 [NT Real COM ] | Reverse Terminal | Server Proprietary Protocol]
05 [NT Real COM ] | Device Control | Server Proprietary Protocol]
06 [NT Real COM ] | Multiplex | Server Proprietary Protocol]
07 [NT Real COM ] | Printer | Server Proprietary Protocol]
08 [NT Real COM ] | Multi-Host TTY | Server Proprietary Protocol]
| NT Real COM
| Raw UDP
|+-----+
    
```

- ASPP mode is selected by default.

```

CN2510-8          CN2510-8_5631  V2.0
-----
[Mode] Line mOdem Welcome_MSG Quit
Examine/modify the operation mode of async ports

ESC: back to menu  Enter:  select

Port Application      Mode      Description/more setting
01 [NT Real COM      ] [ASPP   ] [Async Server Proprietary Protocol]
02 [NT Real COM      ] [ASPP   ] [Async Server Proprietary Protocol]
03 [NT Real COM      ] [ASPP   ] [Async Server Proprietary Protocol]
04 [NT Real COM      ] [ASPP   ] [Async Server Proprietary Protocol]
05 [NT Real COM      ] [ASPP   ] [Async Server Proprietary Protocol]
06 [Device Control   ] [ASPP   ] [Async Server Proprietary Protocol]
07 [NT Real COM      ] [ASPP   ] [Async Server Proprietary Protocol]
    
```

After configuring a port for the Device Control application, you will need to choose between one of two operation modes: **ASPP** and **RAW**. ASPP mode, which was developed by Moxa, provides an easy-to-use TCP/IP socket programming library and other useful functions. Choosing RAW mode gives you more freedom to define your own applications for serial data transmitted and received over the Ethernet. If you select RAW mode, you will need to use standard TCP/IP socket programming techniques.

Configuring ASPP Mode

Moxa ASPP is a TCP/IP socket programming library. If you are using Moxa ASPP to create your programs, configure CN2510's serial ports for ASPP mode, and copy the ASPP library to the server. ASPP programming functions and examples are introduced at the end of this chapter.

Each physical ASPP port is divided into two logical ports. One is called the **command port**, and the other is called the **data port**. The command port is used to issue commands across the network to set the transmission line's configuration parameters, such as baud rate, data bits, flow control condition, etc. The data port is used for normal data transmission tasks, such as retrieving data from the serial device.

Follow these steps to configure ports for ASPP mode:

- Move the cursor to the **Mode** column for the port and press **Enter**.

```

CN2510-8          CN2510-8_5631  V2.0
-----
[Mode] Line mOdem Welcome_MSG Quit
Examine/modify the operation mode of async ports

ESC: back to menu  Enter:  select

Port Application      Mode      Description/more setting
01 [NT Real COM      ] [ASPP   ] [Async Server Proprietary Protocol]
02 [NT Real COM      ] [ASPP   ] [Async Server Proprietary Protocol]
03 [NT Real COM      ] [ASPP   ] [Async Server Proprietary Protocol]
04 [NT Real COM      ] [ASPP   ] [Async Server Proprietary Protocol]
05 [NT Real COM      ] [ASPP   ] [Async Server Proprietary Protocol]
06 [Device Control   ] [ASPP   ] [Async Server Proprietary Protocol]
07 [NT Real COM      ] [ASPP   ] [Async Server Proprietary Protocol]
    
```

- Use the arrow keys to highlight **ASPP**, and then press **Enter**.

```

CN2510-8          CN2510-8_5631  V2.0
-----
[Mode] Line mOdem Welcome_MSG Quit
Examine/modify the operation mode of async ports

ESC: back to menu  Enter:  select

Port Application      Mode      Description/more setting
01 [NT Real COM      ] [ASPP   ] [Async Server Proprietary Protocol]
02 [NT Real COM      ] [ASPP   ] [Async Server Proprietary Protocol]
03 [NT Real COM      ] [ASPP   ] [Async Server Proprietary Protocol]
04 [NT Real COM      ] [ASPP   ] +-----+rver Proprietary Protocol]
05 [NT Real COM      ] [ASPP   ] | ASPP |rver Proprietary Protocol]
06 [Device Control   ] [ASPP   ] | RAW  |rver Proprietary Protocol]
07 [NT Real COM      ] [ASPP   ] +-----+rver Proprietary Protocol]
08 [NT Real COM      ] [ASPP   ] [Async Server Proprietary Protocol]
    
```

- Move the cursor to the **Description/more setting** column and press **Enter**.

```

CN2510-8          CN2510-8_5631  V2.0
-----
[Mode] Line mOdem Welcome_MSG Quit
Examine/modify the operation mode of async ports

ESC: back to menu  Enter:  select

Port Application      Mode      Description/more setting
01 [NT Real COM      ] [ASPP   ] [Async Server Proprietary Protocol]
02 [NT Real COM      ] [ASPP   ] [Async Server Proprietary Protocol]
03 [NT Real COM      ] [ASPP   ] [Async Server Proprietary Protocol]
04 [NT Real COM      ] [ASPP   ] [Async Server Proprietary Protocol]
05 [NT Real COM      ] [ASPP   ] [Async Server Proprietary Protocol]
06 [Device Control   ] [ASPP   ] [Async Server Proprietary Protocol]
07 [NT Real COM      ] [ASPP   ] [Async Server Proprietary Protocol]
    
```

- The pop-up selector contains input/display fields for **TCP data port**, **TCP command port**, and **TCP alive check time**. Each item is described in detail below the figure.

```

CN2510-8          CN2510-8_5631  V2.0
-----
[Mode] Line mOdem Welcome_MSG Quit
Examine/modify the operation mode of async ports

ESC: back to menu  Enter:  select

Port Application      Mod+-----+
01 [NT Real COM      ] [AS| TCP data port      : [950]      |]
02 [NT Real COM      ] [AS| TCP command port   : [966]      |]
03 [NT Real COM      ] [AS| TCP alive check time : [0 ] minutes |]
04 [NT Real COM      ] [AS+-----+
05 [NT Real COM      ] [ASPP   ] [Async Server Proprietary Protocol]
06 [Device Control   ] [ASPP   ] [Async Server Proprietary Protocol]
07 [NT Real COM      ] [ASPP   ] [Async Server Proprietary Protocol]
    
```

Setting	Value	Notes	Necessity												
TCP data port	950 – 965	The host uses this value to determine which serial device to send data to. These values are fixed, and cannot be changed by the user. <table border="1"> <thead> <tr> <th>Serial Port</th> <th>TCP Port No.</th> </tr> </thead> <tbody> <tr><td>01</td><td>950</td></tr> <tr><td>02</td><td>951</td></tr> <tr><td>03</td><td>952</td></tr> <tr><td>...</td><td>...</td></tr> <tr><td>16</td><td>965</td></tr> </tbody> </table>	Serial Port	TCP Port No.	01	950	02	951	03	952	16	965	Required
Serial Port	TCP Port No.														
01	950														
02	951														
03	952														
...	...														
16	965														
TCP command port	966 – 981	The host uses this Port value to determine which device to send commands to. These values are fixed, and cannot be changed by the user. <table border="1"> <thead> <tr> <th>Serial Port</th> <th>TCP Port No.</th> </tr> </thead> <tbody> <tr><td>01</td><td>966</td></tr> <tr><td>02</td><td>967</td></tr> <tr><td>03</td><td>968</td></tr> <tr><td>...</td><td>...</td></tr> <tr><td>16</td><td>981</td></tr> </tbody> </table>	Serial Port	TCP Port No.	01	966	02	967	03	968	16	981	Required
Serial Port	TCP Port No.														
01	966														
02	967														
03	968														
...	...														
16	981														
TCP alive check time	0 – 99 min.	The time period CN2510 waits before checking if the TCP connection is alive or not. If no response is received, CN2510 will reset the port and terminate the connection.	Optional												

5. Press **Esc** to return to the **PORT MENU**.

Configuring RAW Mode

RAW mode is used for standard TCP/IP socket programs. RAW mode provides a transparent communication link between the network socket program and the corresponding serial port.

1. Move the cursor to the **Mode** column for the port and press **Enter**.

```

CN2510-8          CN2510-8_5631  V2.0
-----
[Mode] Line mOdem Welcome_MSG Quit
Examine/modify the operation mode of async ports
ESC: back to menu  Enter:  select
Port Application      Mode      Description/more setting
01 [NT Real COM      ] [ASPP   ] [Async Server Proprietary Protocol]
02 [NT Real COM      ] [ASPP   ] [Async Server Proprietary Protocol]
03 [NT Real COM      ] [ASPP   ] [Async Server Proprietary Protocol]
04 [NT Real COM      ] [ASPP   ] [Async Server Proprietary Protocol]
05 [NT Real COM      ] [ASPP   ] [Async Server Proprietary Protocol]
06 [Device Control  ] [ASPP   ] [Async Server Proprietary Protocol]
07 [NT Real COM      ] [ASPP   ] [Async Server Proprietary Protocol]
    
```

- Use the arrow keys to highlight **RAW**, and then press **Enter**.

```

CN2510-8          CN2510-8_5631  V2.0
-----
[Mode] Line mOdem Welcome_MSG Quit
Examine/modify the operation mode of async ports

ESC: back to menu  Enter: select

Port Application      Mode      Description/more setting
01 [NT Real COM      ] [ASPP   ] [Async Server Proprietary Protocol]
02 [NT Real COM      ] [ASPP   ] [Async Server Proprietary Protocol]
03 [NT Real COM      ] [ASPP   ] [Async Server Proprietary Protocol]
04 [NT Real COM      ] [ASPP   ] +-----+rver Proprietary Protocol]
05 [NT Real COM      ] [ASPP   ] | ASPP   |rver Proprietary Protocol]
06 [Device Control   ] [ASPP   ] | RAW    |rver Proprietary Protocol]
07 [NT Real COM      ] [ASPP   ] +-----+rver Proprietary Protocol]
    
```

- Move the cursor to the **Description/more setting** column, and then press **Enter**. The pop-up selector contains input/display fields for **TCP port**, **Source IP address**, **Destination IP addr**, **Inactivity time**, and **TCP alive check time**. Each item is described in detail below the figure.

```

CN2510-8          CN2510-8_5631  V2.0
-----
[Mode] Line mOdem Welcome_MSG Quit
Examine/modify the operation mode of async ports

ESC: back to menu  Enter: select

Port Application      Mod+-----+
01 [NT Real COM      ] [AS TCP port      : [4001 ]      ]
02 [NT Real COM      ] [AS Source IP address : [          ] ]
03 [NT Real COM      ] [AS Destination IP addr : [          ] ]
05 [NT Real COM      ] [AS Inactivity time   : [0 ] minutes ]
06 [Device Control   ] [RA TCP alive check time : [0 ] minutes ]
07 [NT Real COM      ] [AS+-----+
08 [NT Real COM      ] [ASPP   ] [Async Server Proprietary Protocol]
    
```

Setting	Value	Notes	Necessity
TCP port	number	Each of CN2510's serial ports is mapped to a TCP port. You may modify these port numbers, but to avoid conflicts among TCP port numbers for other serial ports, we strongly suggest using the default values: 4001 for port 1, 4002 for port 2, etc.	Optional
Source IP address	IP address for the port	Specify an IP address for this port for application purposes. If left blank, CN2510 will use its own IP address, in which case you will need to specify different TCP port numbers for different serial ports.	Optional
Destination IP addr	IP address	The host with this IP address will have exclusive access to this port. If left blank, all hosts on the network will have access to this port.	Optional
Inactivity time	0-99 minutes	Idle time before the port is disconnected automatically. If set to 0 minutes, the port will not disconnect.	Optional
TCP alive check time	0-99 minutes	The time period CN2510 waits before checking if the TCP connection is alive or not. If no response is received, CN2510 will reset the port and terminate the connection.	Optional

- Press **Esc** to return to the **PORT MENU**.

Configuring the Serial Ports

Open **Port Menu** → **Line** to configure serial port settings.

- From the **MAIN MENU**, select **Port**, and then press **Enter**.

```

CN2510-8                      CN2510-8_5631  V2.0                      MAIN MENU
-----
Server [Port] seTting sAve Utility Restart Exit
Examine/modify async server ports configuration
Enter: select  ESC: previous menu
    
```

- From the **PORT MENU**, select **Line**, and then press **Enter**.

```

CN2510-8                      CN2510-8_5631  V2.0                      PORT MENU
-----
Mode [Line] mOdem Welcome_MSG Quit
Examine/modify asynchronous port configuration
Enter: select  ESC: previous menu
    
```

- The **Line** page has pop-up selection lists for **Port**, **Speed**, **Bits**, **Stop**, **Parity**, **FIFO**, **RTS/CTS**, **XON/XOFF**, and **Discon. ctrl** for each serial port. Each item is described in detail below the figure.

```

CN2510-8                      CN2510-8_5631  V2.0
-----
Mode [Line] mOdem Welcome_MSG Quit
Examine/modify asynchronous port configuration
ESC: back to menu  Enter: select

Port  Speed  Bits  Stop  Parity  FIFO  RTS/CTS  XON/XOFF  Discon. ctrl
01  [115200] [8]  [ 1 ] [None ] [yes]  [yes]  [no ]  [None ]
02  [115200] [8]  [ 1 ] [None ] [yes]  [yes]  [no ]  [None ]
03  [115200] [8]  [ 1 ] [None ] [yes]  [yes]  [no ]  [None ]
04  [115200] [8]  [ 1 ] [None ] [yes]  [yes]  [no ]  [None ]
05  [115200] [8]  [ 1 ] [None ] [yes]  [yes]  [no ]  [None ]
06  [115200] [8]  [ 1 ] [None ] [yes]  [yes]  [no ]  [None ]
    
```

Setting	Value	Notes
Speed	50 bps to 921.6 Kbps	Transmission rate
Bits	5, 6, 7, 8	Data bits
Stop	1, 1.5, 2	Stop bits
Parity	None, Even, Odd, Mark, Space	Odd, Even, Mark, Space
FIFO	Yes, No	First In First Out Device
RTS/CTS	Yes, No	Hardware Flow Control
XON/XOFF	Yes, No	Software Flow Control
Discon. Ctrl	None	DSR off or DCD off will not be interpreted as a disconnection.
	DSR off	DSR off will be interpreted as a disconnection.
	DCD off	DCD off will be interpreted as a disconnection.

- Press **ESC** to return to the **PORT MENU**.

Save

When exiting the **SERVER MENU**, you will be prompted to save settings. Press **Y** to save.

```

CN2510-8          CN2510-8_5631  V2.0          SERVER MENU
-----
Info. Lan Adv. Host_table Route_table [User_table] Quit
Examine/modify async server basic configuration
Enter: select  ESC: previous menu

+-----+
|                                     |
|          Warning !!!              |
| You had modified the configuration |
| without saving.                   |
| Would you save it now ?          |
|          'Y': yes          'N': no |
|                                     |
+-----+

```

You may also save all settings from the **MAIN MENU** by selecting **sAve** and then pressing **Enter**. Press **Enter** again to save, and any other key to cancel.

```

CN2510-8          CN2510-8_5631  V2.0          MAIN MENU
-----
Server Port seTting [sAve] Utility Restart Exit
Save current configuration to Flash ROM
ESC: back to menu  Enter: select

+-----+
| Enter to updated, other key to cancel |
+-----+

```

Restart

- From the **MAIN MENU**, select **Restart**.

```

CN2510-8          CN2510-8_5631  V2.0          MAIN MENU
-----
Server Port seTting sAve Utility [Restart] Exit
Restart the whole system or selected async ports
Enter: select  ESC: previous menu

```

- Select **System** and then press **Enter** to restart the system and terminate the Telnet session.

```

CN2510-8          CN2510-8_5631  V2.0
-----
[System] Port Quit
Restart the Async Server
ESC: back to menu  Enter: select

+-----+
|                                     |
|          Warning !!!              |
| Restart system will disconnect all |
| ports and clear all status value  |
|                                     |
|          Enter: continue          |
|          ESC: cancel              |
|                                     |
+-----+

```

ASPP Library Introduction

The CN2510 Documentation and Software CD contains example programs that illustrate how to control an ASPP port. After uncompressing the file **ASPP.tar**, the folder **\aspp_unix\aspp.h** will contain several basic subroutines.

The following subroutines are used to control an ASPP port:

1. **sio_init()**—start ASPP Library
2. **sio_open(ipaddr, p)**—open a serial port
3. **sio_close(fd)**—close a serial port
4. **sio_ioctl(fd, baud, mode)**—configure a serial port's baud rate, parity, etc.
5. **sio_baud(fd, baud, mode)**—configure serial port's baud rate
6. **sio_flowctrl(fd, mode)**—configure hardware and/or software flow control
7. **sio_lctrl(fd, mode)**—line control
8. **sio_lstatus(fd)**—check line status
9. **sio_flush(fd, func)**—clear input/output buffer
10. **sio_write(fd, buf, len)**—write data
11. **sio_read(fd, buf, len)**—read data
12. **sio_break(fd, time)**—send break signals
13. **sio_oqueue(fd)**—check how much data is in the output buffer
14. **sio_iqueue(fd)**—check how much data is in the input buffer

ASPP Examples for Unix

In general, controlling devices attached to ASPP ports involves using the following procedures:

1. Create a socket for the command port, and then connect to the port.
2. Configure the port's serial parameters, such as baud rate, via the command port.
3. Create a socket for the data port, and then connect to the port.
4. Transfer data via the data port.

This example program continually sends the string "1234567890" to CN2510's ASPP port and then reads back data when the program ends.

Settings:

Target port: parity = None, data bits = 8, stop bit = 1, software (XON/XOFF) flow control, no hardware (RTS/CTS).

Syntax: # ./example ConsoleServerName [port(1) [Baud(9600)]]

For example:

```
# ./example CN2510 1 19200
```

Program sends "1234567890" to port 1 at 19200 bps baud rate and reads back any data on it.

Environment: SCO UNIX. If you're using another system, modify by including the file name and other variables.

ASPP Examples for Windows

1. Program testing environment:

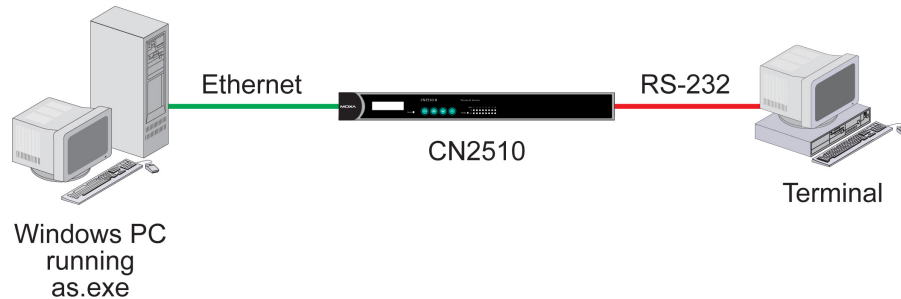

2. This program works like a dumb terminal. It sends all characters pressed on the keyboard to a remote connection, and then echoes the data to the screen.
3. This program sends '\r' as '\r\n' and '\n' as '\r\n'.
4. All CN2510 ASPP functions are defined in the file as.h.
5. The program works on Windows 9x/NT/2000/XP/2003 as a dumb terminal. After completing the connection to CN2510, the serial port will send all characters pressed on the keyboard to the remote connection, and then echo the data to the screen.

6

Setting Up Raw UDP

UDP is a non connection-oriented data transmission method. By circumventing TCP's handshaking process, UDP gains the advantages of fast transmission speed, and high transmission efficiency. The disadvantage is that UDP is unable to guarantee data integrity, since UDP does not re-assemble out-of-order packets, or retransmit packets when data is missing. UDP is an ideal transmission method if you need fast data transmission, and upper-layer application software is given the task of checking data for transmission errors.

CN2510's UDP mode supports 4 configurable groups of IP addresses, allowing data to be broadcast over the network to one or more groups of IP addresses.

The following topics are covered in this chapter:

- Accessing the Console Utility**
- Selecting the Application**
- Configuring RAW UDP Mode**
- Configuring the Serial Ports**
- Save**
- Restart**

Accessing the Console Utility

NOTE In this section, we show how to access CN2510's console utility by Telnet over the network. For information on using the console port, see the section "Accessing the Console Utility" in Chapter 2.

1. Telnet over the network to the server's IP address.

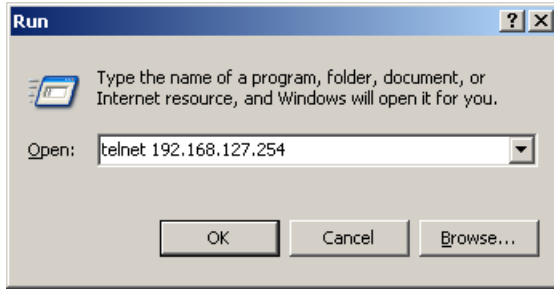

2. Type **1** to choose **ansi/vt100**, and then press **Enter**.

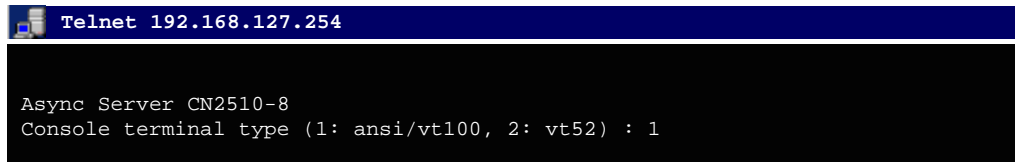

3. CN2510's **MAIN MENU** will open, as shown below.

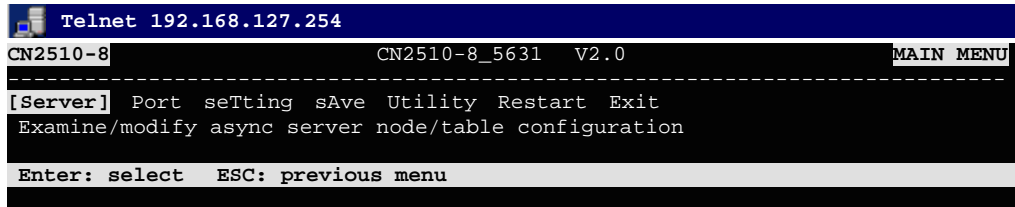

Use the following keystrokes to navigate CN2510's console utility.

Action	Key
Move	[Up/Down/Left/Right] Arrow Key or [Tab] Key
Jump to next menu, or Select item	[Enter] Key
Return to previous menu, or Close pop up selector	[Esc] Key
Shortcut Key	Capitalized letter of the word

Selecting the Application

Open **Port Menu** → **Mode** to configure the **Raw UDP** application.

- From the **MAIN MENU**, select **Port**, and then press **Enter**.

```

CN2510-8          CN2510-8_5631  V2.0          MAIN MENU
-----
Server [Port] seTting sAve Utility Restart Exit
Examine/modify async server ports configuration
Enter: select  ESC: previous menu
    
```

- From the **PORT MENU**, select **Mode**, and then press **Enter**.

```

CN2510-8          CN2510-8_5631  V2.0          PORT MENU
-----
[Mode] Line mOdem Welcome_MSG Quit
Examine/modify the operation mode of async ports
Enter: select  ESC: previous menu
    
```

- The **Mode** page has pop-up selection lists for **Application**, **Mode**, and **Description/more setting** for each serial port. Use the arrow keys to move the cursor to the **Application** column for the port to be configured, and then press **Enter**. We use Port 6 to illustrate.

```

CN2510-8          CN2510-8_5631  V2.0
-----
[Mode] Line mOdem Welcome_MSG Quit
Examine/modify the operation mode of async ports
ESC: back to menu  Enter: select

Port  Application          Mode          Description/more setting
01   [NT Real COM ] [ASPP ] [Async Server Proprietary Protocol]
02   [NT Real COM ] [ASPP ] [Async Server Proprietary Protocol]
03   [NT Real COM ] [ASPP ] [Async Server Proprietary Protocol]
04   [NT Real COM ] [ASPP ] [Async Server Proprietary Protocol]
05   [NT Real COM ] [ASPP ] [Async Server Proprietary Protocol]
06   [NT Real COM ] [ASPP ] [Async Server Proprietary Protocol]
07   [NT Real COM ] [ASPP ] [Async Server Proprietary Protocol]
    
```

- Use the **Up/Down** arrow keys to select **Raw UDP**, and then press **Enter**.

```

CN2510-8          CN2510-8_5631  V2.0
-----
[Mode] Line mOdem Welcome_MSG Quit
Examine/modify the operation mode of async ports
ESC: back to menu  Enter: select

Port  Application          +-----+ption/more setting
01   [NT Real COM ] | Disable | Server Proprietary Protocol]
02   [NT Real COM ] | Dialin/out | Server Proprietary Protocol]
03   [NT Real COM ] | Terminal | Server Proprietary Protocol]
04   [NT Real COM ] | Reverse Terminal | Server Proprietary Protocol]
05   [NT Real COM ] | Device Control | Server Proprietary Protocol]
06   [NT Real COM ] | Multiplex | Server Proprietary Protocol]
07   [NT Real COM ] | Printer | Server Proprietary Protocol]
08   [NT Real COM ] | Multi-Host TTY | Server Proprietary Protocol]
      | NT Real COM |
      | DRDAS |
      | Raw UDP |
      +-----+
    
```

- The only operation mode associated with this application is **RAW UDP**, which is selected automatically in the Mode column.

```

CN2510-8          CN2510-8_5631  V2.0
-----
[Mode] Line mOdem Welcome_MSG Quit
Examine/modify the operation mode of async ports

ESC: back to menu  Enter:  select

Port  Application      Mode      Description/more setting
01   [NT Real COM      ] [ASPP   ] [Async Server Proprietary Protocol]
02   [NT Real COM      ] [ASPP   ] [Async Server Proprietary Protocol]
03   [NT Real COM      ] [ASPP   ] [Async Server Proprietary Protocol]
04   [NT Real COM      ] [ASPP   ] [Async Server Proprietary Protocol]
05   [NT Real COM      ] [ASPP   ] [Async Server Proprietary Protocol]
06   [Raw UDP           ] [RAW UDP] [Pure raw data (UDP) mode          ]
07   [NT Real COM      ] [ASPP   ] [Async Server Proprietary Protocol]
    
```

Configuring RAW UDP Mode

- Move the cursor to the **Description/more setting** column, and then press **Enter**.

```

CN2510-8          CN2510-8_5631  V2.0
-----
[Mode] Line mOdem Welcome_MSG Quit
Examine/modify the operation mode of async ports

ESC: back to menu  Enter:  select

Port  Application      Mode      Description/more setting
01   [NT Real COM      ] [ASPP   ] [Async Server Proprietary Protocol]
02   [NT Real COM      ] [ASPP   ] [Async Server Proprietary Protocol]
03   [NT Real COM      ] [ASPP   ] [Async Server Proprietary Protocol]
03   [NT Real COM      ] [ASPP   ] [Async Server Proprietary Protocol]
04   [NT Real COM      ] [ASPP   ] [Async Server Proprietary Protocol]
05   [NT Real COM      ] [ASPP   ] [Async Server Proprietary Protocol]
06   [Raw UDP           ] [RAW UDP] [Pure raw data (UDP) mode          ]
07   [NT Real COM      ] [ASPP   ] [Async Server Proprietary Protocol]
    
```

- The pop-up selector contains input/display fields for **serial to LAN** and **LAN to serial** parameters, **Local Listen Port**, **Delimiter 1 (Hex)**, **Delimiter 2 (Hex)**, and **Force transmit (ms)**. Each item is described in detail below the figure.

```

+-----+
|          Begin      End      Port      |
| (serial to LAN)    |
| Dest. IP addr 1 [  ] [  ] [  ] |
| Dest. IP addr 2 [  ] [  ] [  ] |
| Dest. IP addr 3 [  ] [  ] [  ] |
| Dest. IP addr 4 [  ] [  ] [  ] |
| (LAN to serial)    |
| Src. IP addr 1 [  ] [  ] [  ] |
| Src. IP addr 2 [  ] [  ] [  ] |
| Src. IP addr 3 [  ] [  ] [  ] |
| Src. IP addr 4 [  ] [  ] [  ] |
| Local Listen Port  : [  ] |
| Delimiter 1 (Hex)  : [  ] |
| Delimiter 2 (Hex)  : [  ] |
| Force transmit (ms) : [  ] |
+-----+
    
```

Setting	Value	Notes	Necessity
Dest. IP address 1/2/3/4	Begin: x.x.x.x End: y.y.y.y Port: 1 to 65535	Defines 1 to 4 groups of IP addresses. UDP packets will be sent through UDP port Port to the range of IP addresses from the Begin IP address to the End IP address.	1: Required (2, 3, 4 are Optional)
Src. IP address 1/2/3/4	Begin: x.x.x.x End: y.y.y.y Port: 1-65535	Defines IP addresses that will be allowed to transmit UDP packets to CN2510's Ethernet port. UDP packets from IP addresses in the range from Begin IP address to End IP address will be accepted through UDP port Port .	1: Required (2, 3, 4 are Optional)
Local Listen Port	1-65535	The UDP port that CN2510 listens to and that other devices must use to contact CN2510. The default is <i>blank</i> . Be sure to choose a Local Listen Port number that does not conflict with the Local Listen Port for CN2510's other serial ports.	Required
Delimiter 1/2 <Hex>	00-FF	Once the CN2510 receives delimiters through its serial port (or the amount of data received exceeds 1K), it immediately packs all data currently in its buffer and sends it out the CN2510's Ethernet port. Note: Delimiter 2 is optional. If left blank, then Delimiter 1 alone trips clearing of the buffer.	Optional
Force transmit <ms>	0-65535	0: Disable this function. 1 to 65535: Forces the CN2510 to try to pack serial data received during the specified time into the same data frame via UDP mode.	Optional
<p>The optimal Force Transmit timeout depends on the application, but it must be at least as large as the time required to transmit one character, for the specified baud rate. For example, assume that the serial port is set to 1200 bps, 8 data bits, 1 stop bit, and none for parity. In this case, the total number of bits required to send a character is 10 bits and the time required to transfer one character is $(10 \text{ bits} / 1200 \text{ bits/s}) * 1000 \text{ ms/s} = 8.3 \text{ ms}$. Therefore, you should set the Force Transmit timeout to be greater than 8.3 ms. The Force Transmit timeout is specified in milliseconds and must be larger than 10 ms.</p> <p>If you want to send a series of characters in the same packet, the serial device attached to CN2510 should send that series of characters during a time interval less than the Force Transmit timeout, and the total length of data must be less than or equal to CN2510's internal buffer size. The serial communication buffer size is 1 KB per port.</p>			

- Press **ESC** to return to **PORT MENU**

Configuring the Serial Ports

Open **Port Menu** → **Line** to configure serial port settings.

- From the **MAIN MENU**, select **Port**, and then press **Enter**.

```

CN2510-8                      CN2510-8_5631  V2.0                      MAIN MENU
-----
Server [Port] seTting sAve Utility Restart Exit
Examine/modify async server ports configuration

Enter: select  ESC: previous menu
    
```

- From the **PORT MENU**, select **Line**, and then press **Enter**.

```

CN2510-8                      CN2510-8_5631  V2.0                      PORT MENU
-----
Mode [Line] mOdem Welcome_MSG Quit
Examine/modify asynchronous port configuration

Enter: select  ESC: previous menu
    
```

- The **Line** page has pop-up selection lists for **Port**, **Speed**, **Bits**, **Stop**, **Parity**, **FIFO**, **RTS/CTS**, **XON/XOFF**, and **Discon. ctrl** for each serial port. Each item is described in detail below the figure.

```

CN2510-8                      CN2510-8_5631  V2.0
-----
Mode [Line] mOdem Welcome_MSG Quit
Examine/modify asynchronous port configuration

ESC: back to menu  Enter: select

Port  Speed  Bits  Stop  Parity  FIFO  RTS/CTS  XON/XOFF  Discon. ctrl
01  [115200] [8]  [ 1 ] [None ] [yes]  [yes]  [no ]  [None ]
02  [115200] [8]  [ 1 ] [None ] [yes]  [yes]  [no ]  [None ]
03  [115200] [8]  [ 1 ] [None ] [yes]  [yes]  [no ]  [None ]
04  [115200] [8]  [ 1 ] [None ] [yes]  [yes]  [no ]  [None ]
05  [115200] [8]  [ 1 ] [None ] [yes]  [yes]  [no ]  [None ]
06  [115200] [8]  [ 1 ] [None ] [yes]  [yes]  [no ]  [None ]
07  [115200] [8]  [ 1 ] [None ] [yes]  [yes]  [no ]  [None ]
08  [115200] [8]  [ 1 ] [None ] [yes]  [yes]  [no ]  [None ]
    
```

Setting	Value	Notes
Speed	50 bps to 921.6 Kbps	Transmission rate
Bits	5, 6, 7, 8	Data bits
Stop	1, 1.5, 2	Stop bits
Parity	None, Even, Odd, Mark, Space	Odd, Even, Mark, Space
FIFO	Yes, No	First In First Out Device
RTS/CTS	Yes, No	Hardware Flow Control
XON/XOFF	Yes, No	Software Flow Control
Discon. Ctrl	None	DSR off or DCD off will not be interpreted as a disconnection.
	DSR off	DSR off will be interpreted as a disconnection.
	DCD off	DCD off will be interpreted as a disconnection.

- Press **ESC** to return to the **PORT MENU**.

Save

When exiting the **SERVER MENU**, you will be prompted to save settings. Press **Y** to save.

```
CN2510-8          CN2510-8_5631  V2.0          SERVER MENU
-----
Info. Lan Adv. Host_table Route_table [User_table] Quit
Examine/modify async server basic configuration
Enter: select  ESC: previous menu

+-----+
|                Warning !!!                |
| You had modified the configuration without saving. |
| Would you save it now ?                    |
|      'Y': yes      'N': no                |
+-----+
```

You may also save all settings from the **MAIN MENU** by selecting **sAve** and then pressing **Enter**. Press **Enter** again to save, and any other key to cancel.

```
CN2510-8          CN2510-8_5631  V2.0          MAIN MENU
-----
Server Port seTting [sAve] Utility Restart Exit
Save current configuration to Flash ROM
ESC: back to menu  Enter: select

+-----+
| Enter to updated, other key to cancel |
+-----+
```

7

Setting Up Reverse Terminal

In this chapter, we show how to use CN2510 to connect terminals to a computer over an Ethernet network.

The following topics are covered in this chapter:

- Accessing the Console Utility**
- Selecting the Application**
- Configuring RTELNET Mode**
- Configuring the Serial Ports**
- Save**
- Restart**

Accessing the Console Utility

NOTE In this section, we show how to access CN2510's console utility by Telnet over the network. For information on using the console port, see the section "Accessing the Console Utility" in Chapter 2.

1. Telnet over the network to the server's IP address.

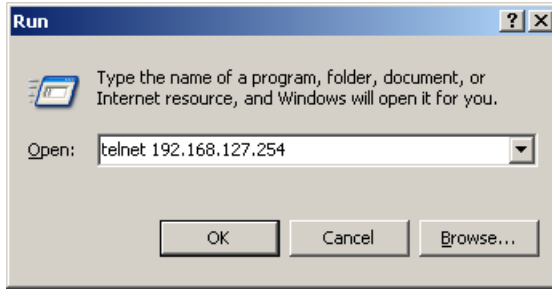

2. Type **1** to choose **ansi/vt100**, and then press **Enter**.

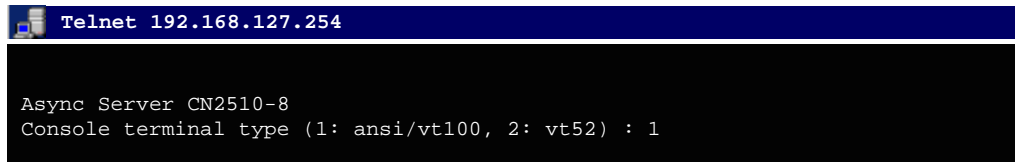

3. CN2510's **MAIN MENU** will open, as shown below.

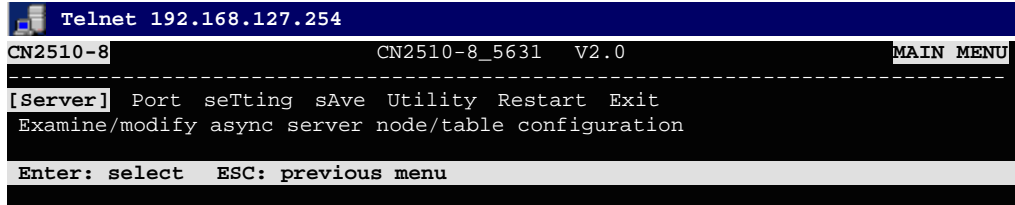

Use the following keystrokes to navigate CN2510's console utility.

Action	Key
Move	[Up/Down/Left/Right] Arrow Key or [Tab] Key
Jump to next menu, or Select item	[Enter] Key
Return to previous menu, or Close pop up selector	[Esc] Key
Shortcut Key	Capitalized letter of the word

Selecting the Application

Open **Port Menu** → **Mode** to configure the **Reverse Terminal** application.

- From the **MAIN MENU**, select **Port**, and then press **Enter**.

```

CN2510-8                CN2510-8_5631  V2.0                MAIN MENU
-----
Server [Port] seTting sAve Utility Restart Exit
Examine/modify async server ports configuration
Enter: select  ESC: previous menu
    
```

- From the **PORT MENU**, select **Mode**, and then press **Enter**.

```

CN2510-8                CN2510-8_5631  V2.0                PORT MENU
-----
[Mode] Line mOdem Welcome_MSG Quit
Examine/modify the operation mode of async ports
Enter: select  ESC: previous menu
    
```

- The **Mode** page has pop-up selection lists for **Application**, **Mode**, and **Description/more setting** for each serial port. Use the arrow keys to move the cursor to the **Application** column for the port to be configured, and then press **Enter**. We use Port 6 to illustrate.

```

CN2510-8                CN2510-8_5631  V2.0
-----
[Mode] Line mOdem Welcome_MSG Quit
Examine/modify the operation mode of async ports
ESC: back to menu  Enter: select

Port Application          Mode          Description/more setting
01 [NT Real COM ] [ASPP ] [Async Server Proprietary Protocol]
02 [NT Real COM ] [ASPP ] [Async Server Proprietary Protocol]
03 [NT Real COM ] [ASPP ] [Async Server Proprietary Protocol]
04 [NT Real COM ] [ASPP ] [Async Server Proprietary Protocol]
05 [NT Real COM ] [ASPP ] [Async Server Proprietary Protocol]
06 [NT Real COM ] [ASPP ] [Async Server Proprietary Protocol]
07 [NT Real COM ] [ASPP ] [Async Server Proprietary Protocol]
08 [NT Real COM ] [ASPP ] [Async Server Proprietary Protocol]
    
```

- Use up/down arrow keys to select **Reverse Terminal**, and then press **Enter**.

```

CN2510-8                CN2510-8_5631  V2.0
-----
[Mode] Line mOdem Welcome_MSG Quit
Examine/modify the operation mode of async ports
ESC: back to menu  Enter: select

Port Application          +-----+ption/more setting
01 [NT Real COM ] | Disable | Server Proprietary Protocol]
02 [NT Real COM ] | Dialin/out | Server Proprietary Protocol]
03 [NT Real COM ] | Terminal | Server Proprietary Protocol]
04 [NT Real COM ] | Reverse Terminal | Server Proprietary Protocol]
05 [NT Real COM ] | Device Control | Server Proprietary Protocol]
06 [NT Real COM ] | Multiplex | Server Proprietary Protocol]
07 [NT Real COM ] | Printer | Server Proprietary Protocol]
08 [NT Real COM ] | Multi-Host TTY | Server Proprietary Protocol]
| NT Real COM |
| DRDAS |
| Raw UDP |
+-----+
    
```

- The only operation mode associated with this application is **Reverse Terminal** mode, which is selected automatically in the Mode column. **RTELNET** mode allows Ethernet hosts to access serial hosts attached to CN2510's serial ports, which is the reverse direction provided by CN2510's terminal application.

```

CN2510-8          CN2510-8_5631  V2.0
-----
[Mode] Line mOdem Welcome_MSG Quit
Examine/modify the operation mode of async ports

ESC: back to menu  Enter:  select

Port Application          Mode          Description/more setting
01 [NT Real COM          ] [ASPP      ] [Async Server Proprietary Protocol]
02 [NT Real COM          ] [ASPP      ] [Async Server Proprietary Protocol]
03 [NT Real COM          ] [ASPP      ] [Async Server Proprietary Protocol]
04 [NT Real COM          ] [ASPP      ] [Async Server Proprietary Protocol]
05 [NT Real COM          ] [ASPP      ] [Async Server Proprietary Protocol]
06 [Reverse Terminal    ] [RTELNET   ] [Reverse Telnet mode                ]
07 [NT Real COM          ] [ASPP      ] [Async Server Proprietary Protocol]
    
```

Configuring RTELNET Mode

Reverse Telnet, or RTELNET, supports the Telnet program used by Ethernet hosts to login to serial hosts. Ethernet hosts recognize serial ports by the specified source IP address, or by the TCP port number followed by CN2510's IP address.

- Move the cursor to the **Description/more setting** column, and then press **Enter**.

```

CN2510-8          CN2510-8_5631  V2.0
-----
[Mode] Line mOdem Welcome_MSG Quit
Examine/modify the operation mode of async ports

ESC: back to menu  Enter:  select

Port Application          Mode          Description/more setting
01 [NT Real COM          ] [ASPP      ] [Async Server Proprietary Protocol]
02 [NT Real COM          ] [ASPP      ] [Async Server Proprietary Protocol]
03 [NT Real COM          ] [ASPP      ] [Async Server Proprietary Protocol]
04 [NT Real COM          ] [ASPP      ] [Async Server Proprietary Protocol]
05 [NT Real COM          ] [ASPP      ] [Async Server Proprietary Protocol]
06 [Reverse Terminal    ] [RTELNET   ] [Reverse Telnet mode                ]
07 [NT Real COM          ] [ASPP      ] [Async Server Proprietary Protocol]
    
```

- The pop-up selector contains input/display fields for **TCP port**, **Source IP address**, **Destination IP addr**, **Inactivity time**, **Map keys <CR-LF> to**, **Authentication type**, and **TCP alive check time**. Each item is described in detail below the figure.

```

+-----+
| TCP port          : [4006  ] |
| Source IP address : [          ] |
| Destination IP addr : [          ] |
| Inactivity time   : [0  ] minutes |
| Map keys <CR-LF> to : [CR-LF] |
| Authentication type : [none  ] |
| TCP alive check time : [0  ] minutes |
+-----+
    
```

Setting	Value	Notes	Necessity
TCP port	number	Each of CN2510's serial ports is mapped to a TCP port. To avoid conflicts with the TCP port numbers for CN251's other serial ports, use the default values: 4001 for port 1, 4002 for port 2, etc.	Optional
Source IP address	IP address for the port	Specify an IP address for this port for application purposes. If left blank, CN2510 will use its own IP address, in which case you will need to specify different TCP port numbers for different serial ports.	Optional
Destination IP addr	IP address	Assign a host IP address on the LAN for exclusive port access. If left blank, all hosts on the network will have access to this port.	Optional
Map Keys <CR-LF> to	CR/LF/CR-LF	When you enter the string <CR-LF>, CN2510 will determine whether to send <CR>, <LF>, or <CR-LF>.	Optional
Inactivity time	0-99 minutes	Idle time before the port is disconnected automatically. If set to 0 minutes, the port will not disconnect.	Optional
Authentication type	None/local /server	None: Authentication is not required. local: Check the ID stored in the User_table (defined under the SERVER MENU). Server: Check the ID with the external RADIUS server. Refer to Appendix C for RADIUS installation information.	Optional
TCP alive check time	0-99 minutes	The time period CN2510 waits before checking if the TCP connection is alive or not. If no response is received, CN2510 will reset the port and terminate the connection.	Optional

3. Press **Esc** to return to **PORT MENU**.

Configuring the Serial Ports

Open **Port Menu** → **Line** to configure serial port settings.

1. From the **MAIN MENU**, select **Port**, and then press **Enter**.

```

CN2510-8                CN2510-8_5631  V2.0                MAIN MENU
-----
Server [Port] seTting sAve Utility Restart Exit
Examine/modify async server ports configuration
Enter: select  ESC: previous menu
    
```

- From the **PORT MENU**, select **Line**, and then press **Enter**.

```

CN2510-8                               CN2510-8_5631  V2.0                                PORT MENU
-----
Mode [Line]  mOdem  Welcome_MSG  Quit
Examine/modify asynchronous port configuration

Enter: select  ESC: previous menu
    
```

- The **Line** page has pop-up selection lists for **Port**, **Speed**, **Bits**, **Stop**, **Parity**, **FIFO**, **RTS/CTS**, **XON/XOFF**, and **Discon. ctrl** for each serial port. Each item is described in detail below the figure.

```

CN2510-8                               CN2510-8_5631  V2.0                                PORT MENU
-----
Mode [Line]  mOdem  Welcome_MSG  Quit
Examine/modify asynchronous port configuration

ESC: back to menu  Enter: select

Port  Speed  Bits  Stop  Parity  FIFO  RTS/CTS  XON/XOFF  Discon. ctrl
01  [115200] [8]  [ 1 ] [None ] [yes]  [yes]  [no ]  [None ]
02  [115200] [8]  [ 1 ] [None ] [yes]  [yes]  [no ]  [None ]
03  [115200] [8]  [ 1 ] [None ] [yes]  [yes]  [no ]  [None ]
04  [115200] [8]  [ 1 ] [None ] [yes]  [yes]  [no ]  [None ]
05  [115200] [8]  [ 1 ] [None ] [yes]  [yes]  [no ]  [None ]
06  [115200] [8]  [ 1 ] [None ] [yes]  [yes]  [no ]  [None ]
07  [115200] [8]  [ 1 ] [None ] [yes]  [yes]  [no ]  [None ]
08  [115200] [8]  [ 1 ] [None ] [yes]  [yes]  [no ]  [None ]
    
```

Setting	Value	Notes
Speed	50 bps to 921.6 Kbps	Transmission rate
Bits	5, 6, 7, 8	Data bits
Stop	1, 1.5, 2	Stop bits
Parity	None, Even, Odd, Mark, Space	Odd, Even, Mark, Space
FIFO	Yes, No	First In First Out Device
RTS/CTS	Yes, No	Hardware Flow Control
XON/XOFF	Yes, No	Software Flow Control
Discon. Ctrl	None	DSR off or DCD off will not be interpreted as a disconnection.
	DSR off	DSR off will be interpreted as a disconnection.
	DCD off	DCD off will be interpreted as a disconnection.

- Press **ESC** to return to the **Port Menu**.

Save

When exiting the **SERVER MENU**, you will be prompted to save settings. Press **Y** to save.

```
CN2510-8          CN2510-8_5631  V2.0          SERVER MENU
-----
Info. Lan Adv. Host_table Route_table [User_table] Quit
Examine/modify async server basic configuration
Enter: select  ESC: previous menu

+-----+
|                                     |
|               Warning !!!          |
| You had modified the configuration  |
| without saving.                    |
| Would you save it now ?            |
| 'Y': yes      'N': no              |
|                                     |
+-----+
```

You may also save all settings from the **MAIN MENU** by selecting **sAve** and then pressing **Enter**. Press **Enter** again to save, and any other key to cancel.

```
CN2510-8          CN2510-8_5631  V2.0          MAIN MENU
-----
Server Port seTting [sAve] Utility Restart Exit
Save current configuration to Flash ROM
ESC: back to menu  Enter: select

+-----+
| Enter to updated, other key to cancel |
+-----+
```

Restart

- From the **MAIN MENU**, select **Restart**.

```
CN2510-8          CN2510-8_5631  V2.0          MAIN MENU
-----
Server Port seTting sAve Utility [Restart] Exit
Restart the whole system or selected async ports
Enter: select  ESC: previous menu
```

- Select **System** and then press **Enter** to restart the system and terminate the Telnet session.

```
CN2510-8          CN2510-8_5631  V2.0
-----
[System] Port Quit
Restart the Async Server
ESC: back to menu  Enter: select

+-----+
|                                     |
|               Warning !!!          |
| Restart system will disconnect all  |
| ports and clear all status value   |
|                                     |
|               Enter: continue      |
|               ESC: cancel          |
|                                     |
+-----+
```

Setting Up Terminal

In this chapter, we describe the steps you should follow to configure Moxa CN2510 as a Terminal Server. CN2510 provides Telnet and Rlogin protocols for terminals to establish connections with UNIX hosts. Two terminal modes are supported—ASCII terminal with up to 8 simultaneous sessions, and Binary terminal with one session for one user. Terminals can be connected directly to one of CN2510's RS-232 ports, or connected from a remote site by using external modems.

The following topics are covered in this chapter:

- Accessing the Console Utility**
- Selecting the Application**
- Configuring TERM_ASC Mode**
- Configuring TERM_BIN Mode**
- Configuring the Serial Ports**
- Save**
- Restart**

Accessing the Console Utility

NOTE In this section, we show how to access CN2510's console utility by Telnet over the network. For information on using the console port, see the section "Accessing the Console Utility" in Chapter 2.

1. Telnet over the network to the server's IP address.

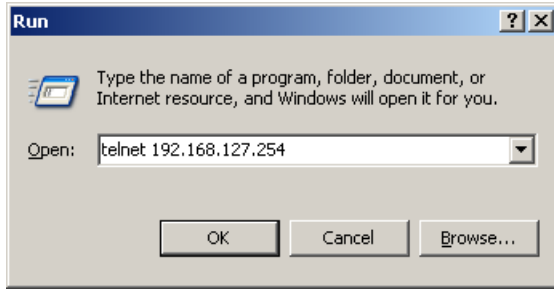

2. Type **1** to choose **ansi/vt100**, and then press **Enter**.

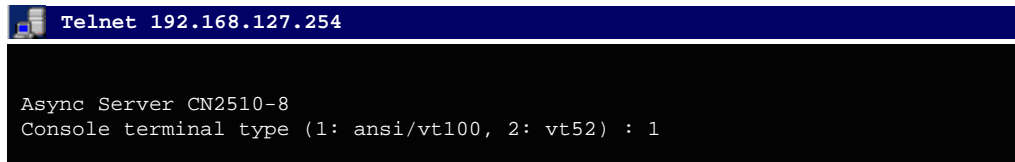

3. CN2510's **MAIN MENU** will open, as shown below.

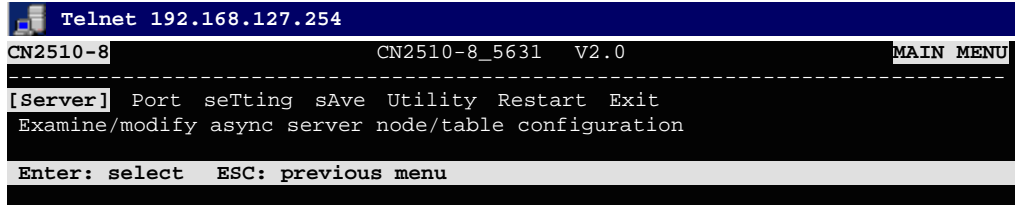

Use the following keystrokes to navigate CN2510's console utility.

Action	Key
Move	[Up/Down/Left/Right] Arrow Key or [Tab] Key
Jump to next menu, or Select item	[Enter] Key
Return to previous menu, or Close pop up selector	[Esc] Key
Shortcut Key	Capitalized letter of the word

Selecting the Application

Open **Port Menu** → **Mode** to configure the **Terminal** application.

- From the **MAIN MENU**, select **Port**, and then press **Enter**.

```

CN2510-8                CN2510-8_5631  V2.0                MAIN MENU
-----
Server [Port] seTting sAve Utility Restart Exit
Examine/modify async server ports configuration
Enter: select  ESC: previous menu
    
```

- From the **PORT MENU**, select **Mode**, and then press **Enter**.

```

CN2510-8                CN2510-8_5631  V2.0                PORT MENU
-----
[Mode] Line mOdem Welcome_MSG Quit
Examine/modify the operation mode of async ports
Enter: select  ESC: previous menu
    
```

- The **Mode** page has pop-up selection lists for **Application**, **Mode**, and **Description/more setting** for each serial port. Use the arrow keys to move the cursor to the **Application** column for the port to be configured, and then press **Enter**. We use Port 6 to illustrate.

```

CN2510-8                CN2510-8_5631  V2.0
-----
[Mode] Line mOdem Welcome_MSG Quit
Examine/modify the operation mode of async ports
ESC: back to menu  Enter: select

Port  Application          Mode          Description/more setting
01   [NT Real COM ] [ASPP ] [Async Server Proprietary Protocol]
02   [NT Real COM ] [ASPP ] [Async Server Proprietary Protocol]
03   [NT Real COM ] [ASPP ] [Async Server Proprietary Protocol]
04   [NT Real COM ] [ASPP ] [Async Server Proprietary Protocol]
05   [NT Real COM ] [ASPP ] [Async Server Proprietary Protocol]
06   [NT Real COM ] [ASPP ] [Async Server Proprietary Protocol]
07   [NT Real COM ] [ASPP ] [Async Server Proprietary Protocol]
08   [NT Real COM ] [ASPP ] [Async Server Proprietary Protocol]
    
```

- Use the up/down arrow keys to select **Terminal**, and then press **Enter**.

```

CN2510-8                CN2510-8_5631  V2.0
-----
[Mode] Line mOdem Welcome_MSG Quit
Examine/modify the operation mode of async ports
ESC: back to menu  Enter: select

Port  Application          +-----+ption/more setting
01   [NT Real COM ] | Disable | Server Proprietary Protocol]
02   [NT Real COM ] | Dialin/out | Server Proprietary Protocol]
03   [NT Real COM ] | Terminal | Server Proprietary Protocol]
04   [NT Real COM ] | Reverse Terminal | Server Proprietary Protocol]
05   [NT Real COM ] | Device Control | Server Proprietary Protocol]
06   [NT Real COM ] | Multiplex | Server Proprietary Protocol]
07   [NT Real COM ] | Printer | Server Proprietary Protocol]
08   [NT Real COM ] | Multi-Host TTY | Server Proprietary Protocol]
      | NT Real COM |
      | DRDAS |
      | Raw UDP |
      +-----+
    
```

5. TERM_ASC mode is selected by default.

```

CN2510-8          CN2510-8_5631  V2.0
-----
[Mode] Line mOdem Welcome_MSG Quit
Examine/modify the operation mode of async ports

ESC: back to menu  Enter:  select

Port Application      Mode      Description/more setting
01 [NT Real COM      ] [ASPP   ] [Async Server Proprietary Protocol]
02 [NT Real COM      ] [ASPP   ] [Async Server Proprietary Protocol]
03 [NT Real COM      ] [ASPP   ] [Async Server Proprietary Protocol]
04 [NT Real COM      ] [ASPP   ] [Async Server Proprietary Protocol]
05 [NT Real COM      ] [ASPP   ] [Async Server Proprietary Protocol]
06 [Terminal         ] [TERM_ASC] [ASCII Termianl mode (8 sessions) ]
07 [NT Real COM      ] [ASPP   ] [Async Server Proprietary Protocol]
    
```

After configuring a port for the Terminal application, you will need to choose between one of two operation modes: **TERM_ASC** and **TERM_BIN**. The default mode, **TERM_ASC** (short for Terminal ASCII), supports 8 terminal sessions. The other option, **TERM_BIN** (short for Terminal Binary) only supports 1 session.

Configuring TERM_ASC Mode

TERM_ASC supports 8 terminal sessions for each terminal. Hot keys are used to switch between different sessions.

1. Move the cursor to the **Mode** column for the port and press **Enter**.

```

CN2510-8          CN2510-8_5631  V2.0
-----
[Mode] Line mOdem Welcome_MSG Quit
Examine/modify the operation mode of async ports

ESC: back to menu  Enter:  select

Port Application      Mode      Description/more setting
01 [NT Real COM      ] [ASPP   ] [Async Server Proprietary Protocol]
02 [NT Real COM      ] [ASPP   ] [Async Server Proprietary Protocol]
03 [NT Real COM      ] [ASPP   ] [Async Server Proprietary Protocol]
04 [NT Real COM      ] [ASPP   ] [Async Server Proprietary Protocol]
05 [NT Real COM      ] [ASPP   ] [Async Server Proprietary Protocol]
06 [Terminal         ] [TERM_ASC] [ASCII Termianl mode (8 sessions) ]
07 [NT Real COM      ] [ASPP   ] [Async Server Proprietary Protocol]
    
```

2. Use the arrow keys to highlight **TERM_ASC**, and then press **Enter**.

```

CN2510-8          CN2510-8_5631  V2.0
-----
[Mode] Line mOdem Welcome_MSG Quit
Examine/modify the operation mode of async ports

ESC: back to menu  Enter:  select

Port Application      Mode      Description/more setting
01 [NT Real COM      ] [ASPP   ] [Async Server Proprietary Protocol]
02 [NT Real COM      ] [ASPP   ] [Async Server Proprietary Protocol]
03 [NT Real COM      ] [ASPP   ] [Async Server Proprietary Protocol]
04 [NT Real COM      ] [ASPP   ] [Async Server Proprietary Protocol]
05 [NT Real COM      ] [ASPP   ] [TERM_ASC] [rver Proprietary Protocol]
06 [Terminal         ] [TERM_ASC] | TERM_BIN |rminal mode (8 sessions) ]
07 [NT Real COM      ] [ASPP   ] [Async Server Proprietary Protocol]
08 [NT Real COM      ] [ASPP   ] [Async Server Proprietary Protocol]
    
```

3. Move the cursor to the **Description/more setting** column and press **Enter**.

```

CN2510-8          CN2510-8_5631  V2.0
-----
[Mode] Line mOdem Welcome_MSG Quit
Examine/modify the operation mode of async ports
ESC: back to menu  Enter:  select
-----
Port  Application          Mode          Description/more setting
01   [NT Real COM          ] [ASPP        ] [Async Server Proprietary Protocol]
02   [NT Real COM          ] [ASPP        ] [Async Server Proprietary Protocol]
03   [NT Real COM          ] [ASPP        ] [Async Server Proprietary Protocol]
04   [NT Real COM          ] [ASPP        ] [Async Server Proprietary Protocol]
05   [NT Real COM          ] [ASPP        ] [Async Server Proprietary Protocol]
06   [Terminal             ] [TERM_ASC    ] [ASCII Terminal mode (8 sessions)]
07   [NT Real COM          ] [ASPP        ] [Async Server Proprietary Protocol]
08   [NT Real COM          ] [ASPP        ] [Async Server Proprietary Protocol]
    
```

4. The pop-up selector contains input/display fields for **Key Mapping**, **Auto-link protocol**, **Link by input IP**, **Auto-login prompt**, **Terminal type**, **Inactivity time**, **Authentication type**, and **TCP alive check time**. Each item is described in detail below the figure.

```

-----+-----
Key Mapping :
  Max. Sessions      : [ 4 ]
  Change Session     : [ ^T ]
  Quit               : [ ^E ]
  Break              : [   ]
  Interrupt          : [   ]
  Auto-link protocol : [none  ]
  Telnet TCP port    : [23   ]
  Primary host IP    : [     ]
  Link by input IP   : [Disable]
  Secondary host IP  : [     ]
  Auto-login prompt  : [ogin:  ]
  Password prompt    : [assword:]
  Login user name    : [     ]
  Login password     : [     ]
  Terminal type      : [ansi   ]
  Inactivity time    : [0   ] minutes
  Authentication type : [local  ]
  TCP alive check time : [0   ] minutes
-----+-----
    
```

Setting	Value	Notes	Necessity
Key Mapping			
Max. Sessions	1-8	Configure the max. number of sessions	Optional
Change Session	^T	Hot key for changing sessions	Optional
Quit	^E	Hot key for quitting a session	Optional
Erase-line		Hot key for erase-line	Optional
Break		Hot key for sending Telnet break signal	Optional
Interrupt		Hot key for program termination	Optional
Auto-link protocol	None/Telnet/Rlogin	None: Do not connect to the host automatically. Telnet: Connects to the host automatically by Telnet. Rlogin: Connects to the host automatically by Rlogin.	Optional

Setting	Value	Notes	Necessity
Telnet TCP port	23	By default, the Telnet TCP port number is set to 23, which is the default TCP port number for Telnet. If you need to telnet to this CN2510 serial port, set the Telnet TCP port to a different number. We recommend using 4001, 4002, etc. for ports 1, 2, etc. to avoid conflicts with other ports.	Optional
Primary host IP	IP address or the name defined in the [Host] table	If specified, designates a 'permanent' host to which the terminal will always be connected.	Optional
Link by input IP	Enable/Disable	For users to enter the connection IP address manually.	Optional
Secondary host IP	IP address or the name defined in the [Host] table.	If specified, designates a secondary 'permanent' host to which the terminal will be connected.	Optional
Auto-login prompt	ogin:	Send ID information when this prompt is received.	Optional
Password prompt	assword:	Send Password information when this prompt is received	Optional
Login user name		Login ID	Optional
Login password		Login Password	Optional
Terminal type	ansi	Terminal type for outgoing connection	Optional
Inactivity time	0-99 minutes	Idle time before the port is disconnected automatically. If set to 0 minutes, the port will not disconnect.	Optional
Authentication type	None/local/server	None: Authentication is not required. local: Check the ID stored in the User_table (defined under the SERVER MENU). Server: Check the ID with the external RADIUS server. Refer to Appendix C for RADIUS installation information.	Optional
TCP alive check time	0-99 minutes	The time period CN2510 waits before checking if the TCP connection is alive or not. If no response is received, CN2510 will reset the port and terminate the connection.	Optional

5. Press **Esc** to return to the **PORT MENU**.

Configuring TERM_BIN Mode

TERM_BIN (Terminal Binary) mode is used as an application protocol. For example, it can be used to transfer files with XMODEM or ZMODEM. You are only allowed to open one terminal session at a time when in Terminal Binary mode.

1. Move the cursor to the **Mode** column for the port and press **Enter**.

```

CN2510-8          CN2510-8_5631  V2.0
-----
[Mode] Line mOdem Welcome_MSG Quit
Examine/modify the operation mode of async ports

ESC: back to menu  Enter: select

Port Application      Mode      Description/more setting
01 [NT Real COM      ] [ASPP   ] [Async Server Proprietary Protocol]
02 [NT Real COM      ] [ASPP   ] [Async Server Proprietary Protocol]
03 [NT Real COM      ] [ASPP   ] [Async Server Proprietary Protocol]
04 [NT Real COM      ] [ASPP   ] [Async Server Proprietary Protocol]
05 [NT Real COM      ] [ASPP   ] [Async Server Proprietary Protocol]
06 [Terminal         ] [TERM_ASC] [ASCII Terminal mode (8 sessions) ]
07 [NT Real COM      ] [ASPP   ] [Async Server Proprietary Protocol]
    
```

2. Use the arrow keys to highlight **TERM_BIN**, and then press **Enter**.

```

CN2510-8          CN2510-8_5631  V2.0
-----
[Mode] Line mOdem Welcome_MSG Quit
Examine/modify the operation mode of async ports

ESC: back to menu  Enter: select

Port Application      Mode      Description/more setting
01 [NT Real COM      ] [ASPP   ] [Async Server Proprietary Protocol]
02 [NT Real COM      ] [ASPP   ] [Async Server Proprietary Protocol]
03 [NT Real COM      ] [ASPP   ] [Async Server Proprietary Protocol]
04 [NT Real COM      ] [ASPP   ] [Async Server Proprietary Protocol]
05 [NT Real COM      ] [ASPP   ] [Async Server Proprietary Protocol]
06 [Terminal         ] [TERM_ASC] [TERM_BIN] [Terminal mode (8 sessions) ]
07 [NT Real COM      ] [ASPP   ] [Async Server Proprietary Protocol]
08 [NT Real COM      ] [ASPP   ] [Async Server Proprietary Protocol]
    
```

3. Move the cursor to the **Description/more setting** column and press **Enter**.

```

CN2510-8          CN2510-8_5631  V2.0
-----
[Mode] Line mOdem Welcome_MSG Quit
Examine/modify the operation mode of async ports

ESC: back to menu  Enter: select

Port Application      Mode      Description/more setting
01 [NT Real COM      ] [ASPP   ] [Async Server Proprietary Protocol]
02 [NT Real COM      ] [ASPP   ] [Async Server Proprietary Protocol]
03 [NT Real COM      ] [ASPP   ] [Async Server Proprietary Protocol]
04 [NT Real COM      ] [ASPP   ] [Async Server Proprietary Protocol]
05 [NT Real COM      ] [ASPP   ] [Async Server Proprietary Protocol]
06 [Terminal         ] [TERM_BIN] [Binary Terminal mode (1 session) ]
07 [NT Real COM      ] [ASPP   ] [Async Server Proprietary Protocol]
08 [NT Real COM      ] [ASPP   ] [Async Server Proprietary Protocol]
    
```

4. The pop-up selector contains input/display fields for **Quit key**, **Auto-link protocol**, **Link by input IP**, **Auto-login prompt**, **Terminal type**, **Inactivity time**, **Authentication type**, and **TCP alive check time**. Each item is described in detail below the figure.

```

Quit key          : [^E]
Auto-link protocol : [none  ]
  Telnet TCP port  : [23   ]
  Primary host IP  : [          ]
Link by input IP  : [Disable]
  Secondary host IP : [          ]
Auto-login prompt : [ogin:  ]
  Password prompt  : [assword:]
  Login user name   : [          ]
  Login password    : [          ]
Terminal type     : [ansi  ]
Inactivity time   : [0   ] minutes
Authentication type : [local ]
TCP alive check time : [0   ] minutes
    
```

Setting	Value	Notes	Necessity
Quit Key	^E	Defines the Quit key used to disconnect the link between the current terminal session and the remote host. It may be left blank for binary communication.	Optional
Auto-link protocol	None/Telnet/Rlogin	None: Do not connect to the host automatically. Telnet: Connects to the host automatically by Telnet. Rlogin: Connects to the host automatically by Rlogin.	Optional
Telnet TCP port	23	By default, the Telnet TCP port number is set to 23, which is the default TCP port number for Telnet. If you need to telnet to this CN2510 serial port, set the Telnet TCP port to a different number. We recommend using 4001, 4002, etc. for ports 1, 2, etc. to avoid conflicts with other ports.	Optional
Primary host IP	IP address or the name defined in the [Host] table	If specified, designates a 'permanent' host to which the terminal will always be connected.	Optional
Link by input IP	Enable/Disable	For users to enter the connection IP address manually.	Optional
Secondary host IP	IP address or the name defined in the [Host] table.	If specified, designates a secondary 'permanent' host to which the terminal will be connected.	Optional
Auto-login prompt	ogin:	Send ID information when this prompt is received.	Optional
Password prompt	assword:	Send Password information when this prompt is received	Optional
Login user name		Login ID	Optional

Setting	Value	Notes	Necessity
Login password		Login Password	Optional
Terminal type	ansi	Terminal type for outgoing connection	Optional
Inactivity time	0-99 minutes	Idle time before the port is disconnected automatically. If set to 0 minutes, the port will not disconnect.	Optional
Authentication type	None/local/server	None: Authentication is not required. local: Check the ID stored in the User_table (defined under the SERVER MENU). Server: Check the ID with the external RADIUS server. Refer to Appendix C for RADIUS installation information.	Optional
TCP alive check time	0-99 minutes	The time period CN2510 waits before checking if the TCP connection is alive or not. If no response is received, CN2510 will reset the port and terminate the connection.	Optional

5. Press **Esc** to return to the **PORT MENU**.

Configuring the Serial Ports

Open **Port Menu** → **Line** to configure serial port settings.

1. From the **MAIN MENU**, select **Port**, and then press **Enter**.

```

CN2510-8                CN2510-8_5631  V2.0                MAIN MENU
-----
Server [Port] seTting sAve Utility Restart Exit
Examine/modify async server ports configuration

Enter: select  ESC: previous menu
    
```

2. From the **PORT MENU**, select **Line**, and then press **Enter**.

```

CN2510-8                CN2510-8_5631  V2.0                PORT MENU
-----
Mode [Line] mOdem Welcome_MSG Quit
Examine/modify asynchronous port configuration

Enter: select  ESC: previous menu
    
```

You may also save all settings from the **MAIN MENU** by selecting **sAve** and then pressing **Enter**. Press **Enter** again to save, and any other key to cancel.

```

CN2510-8          CN2510-8_5631  V2.0          MAIN MENU
-----
Server Port seTting [sAve] Utility Restart Exit
Save current configuration to Flash ROM
ESC: back to menu  Enter:  select

+-----+
|Enter to updated, other key to cancel|
+-----+
    
```

Restart

1. From the **MAIN MENU**, select **Restart**.

```

CN2510-8          CN2510-8_5631  V2.0          MAIN MENU
-----
Server Port seTting sAve Utility [Restart] Exit
Restart the whole system or selected async ports
Enter: select  ESC: previous menu
    
```

2. Select **System** and then press **Enter** to restart the system and terminate the Telnet session.

```

CN2510-8          CN2510-8_5631  V2.0
-----
[System] Port Quit
Restart the Async Server
ESC: back to menu  Enter:  select

+-----+
|                               Warning !!!                               |
| Restart system will disconnect all ports and clear all status value |
|                               Enter: continue   ESC: cancel           |
+-----+
    
```

Setting Up Multi-host TTY

The Multi-host TTY application is the ideal transmission method for communicating with multiple Unix hosts over the network via several simultaneous sessions.

When the communication starts, a Unix server connected to the network must first activate Moxattyd to use the TTY port's mapping function. Moxattyd will initiate the connection with the CN2510, and the CN2510 will listen on different TCP ports for connection requests from various Moxattyd.

Once a connection is established, the Terminal server can use hot keys to switch sessions. In this way, one terminal can control different Unix hosts.

The following topics are covered in this chapter:

- Accessing the Console Utility**
- Selecting the Application**
- Configuring FIXTTY Mode**
- Configuring the Serial Ports**
- Save**
- Restart**
- Setting up Hosts**
 - Installing and Compiling Moxatty
 - Moxatty for Different Applications
 - Using Moxatty

Accessing the Console Utility

NOTE In this section, we show how to access CN2510's console utility by Telnet over the network. For information on using the console port, see the section "Accessing the Console Utility" in Chapter 2.

1. Telnet over the network to the server's IP address.

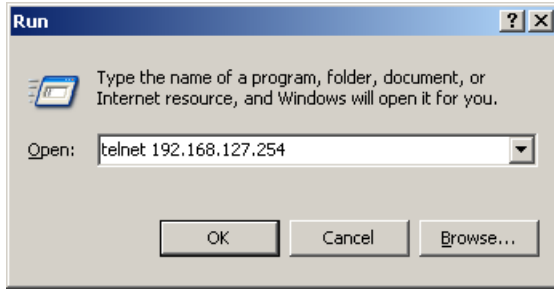

2. Type **1** to choose **ansi/vt100**, and then press **Enter**.

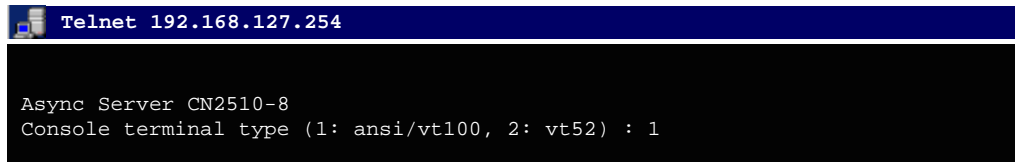

3. CN2510's **MAIN MENU** will open, as shown below.

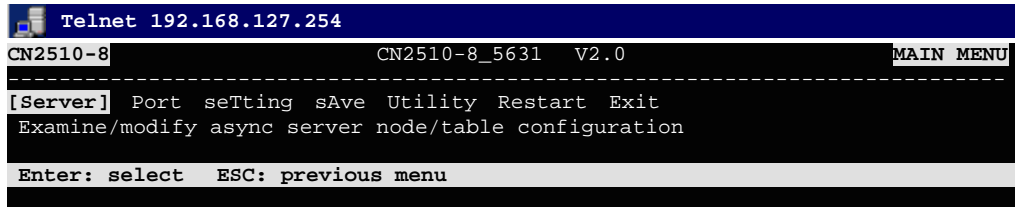

Use the following keystrokes to navigate CN2510's console utility.

Action	Key
Move	[Up/Down/Left/Right] Arrow Key or [Tab] Key
Jump to next menu, or Select item	[Enter] Key
Return to previous menu, or Close pop up selector	[Esc] Key
Shortcut Key	Capitalized letter of the word

Selecting the Application

Open **Port Menu** → **Mode** to configure the **Multi-host TTY** application.

- From the **MAIN MENU**, select **Port**, and then press **Enter**.

```

CN2510-8                CN2510-8_5631  V2.0                MAIN MENU
-----
Server [Port] seTting sAve Utility Restart Exit
Examine/modify async server ports configuration

Enter: select  ESC: previous menu
    
```

- From the **PORT MENU**, select **Mode**, and then press **Enter**.

```

CN2510-8                CN2510-8_5631  V2.0                PORT MENU
-----
[Mode] Line mOdem Welcome_MSG Quit
Examine/modify the operation mode of async ports

Enter: select  ESC: previous menu
    
```

- The **Mode** page has pop-up selection lists for **Application**, **Mode**, and **Description/more setting** for each serial port. Use the arrow keys to move the cursor to the **Application** column for the port to be configured, and then press **Enter**. We use Port 6 to illustrate.

```

CN2510-8                CN2510-8_5631  V2.0
-----
[Mode] Line mOdem Welcome_MSG Quit
Examine/modify the operation mode of async ports

ESC: back to menu  Enter: select

Port  Application          Mode          Description/more setting
01   [NT Real COM ] [ASPP ] [Async Server Proprietary Protocol]
02   [NT Real COM ] [ASPP ] [Async Server Proprietary Protocol]
03   [NT Real COM ] [ASPP ] [Async Server Proprietary Protocol]
04   [NT Real COM ] [ASPP ] [Async Server Proprietary Protocol]
05   [NT Real COM ] [ASPP ] [Async Server Proprietary Protocol]
06   [NT Real COM ] [ASPP ] [Async Server Proprietary Protocol]
07   [NT Real COM ] [ASPP ] [Async Server Proprietary Protocol]
08   [NT Real COM ] [ASPP ] [Async Server Proprietary Protocol]
    
```

- Use the up/down arrow keys to select **Multi-Host TTY**, and then press **Enter**.

```

CN2510-8                CN2510-8_5631  V2.0
-----
[Mode] Line mOdem Welcome_MSG Quit
Examine/modify the operation mode of async ports

ESC: back to menu  Enter: select

Port  Application          +-----+ption/more setting
01   [NT Real COM ] | Disable | Server Proprietary Protocol]
02   [NT Real COM ] | Dialin/out | Server Proprietary Protocol]
03   [NT Real COM ] | Terminal | Server Proprietary Protocol]
04   [NT Real COM ] | Reverse Terminal | Server Proprietary Protocol]
05   [NT Real COM ] | Device Control | Server Proprietary Protocol]
06   [NT Real COM ] | Multiplex | Server Proprietary Protocol]
07   [NT Real COM ] | Printer | Server Proprietary Protocol]
08   [NT Real COM ] | Multi-Host TTY | Server Proprietary Protocol]
      | NT Real COM |
      | DRDAS |
      | Raw UDP |
      +-----+
    
```

- The only operation mode associated with this application is **FIXTTY** mode, which is selected automatically in the Mode column.

```

CN2510-8          CN2510-8_5631  V2.0
-----
[Mode] Line mOdem Welcome_MSG Quit
Examine/modify the operation mode of async ports

ESC: back to menu  Enter:  select

Port Application      Mode      Description/more setting
01 [NT Real COM      ] [ASPP   ] [Async Server Proprietary Protocol]
02 [NT Real COM      ] [ASPP   ] [Async Server Proprietary Protocol]
03 [NT Real COM      ] [ASPP   ] [Async Server Proprietary Protocol]
04 [NT Real COM      ] [ASPP   ] [Async Server Proprietary Protocol]
05 [NT Real COM      ] [ASPP   ] [Async Server Proprietary Protocol]
06 [Multi-Host TTY   ] [FIXTTY ] [Unix fixtty driver mode      ]
04 [NT Real COM      ] [ASPP   ] [Async Server Proprietary Protocol]
05 [NT Real COM      ] [ASPP   ] [Async Server Proprietary Protocol]
    
```

Configuring FIXTTY Mode

- Move cursor to the **Description/more setting** column and then press **Enter**.

```

CN2510-8          CN2510-8_5631  V2.0
-----
[Mode] Line mOdem Welcome_MSG Quit
Examine/modify the operation mode of async ports

ESC: back to menu  Enter:  select

Port Application      Mode      Description/more setting
01 [NT Real COM      ] [ASPP   ] [Async Server Proprietary Protocol]
02 [NT Real COM      ] [ASPP   ] [Async Server Proprietary Protocol]
03 [NT Real COM      ] [ASPP   ] [Async Server Proprietary Protocol]
04 [NT Real COM      ] [ASPP   ] [Async Server Proprietary Protocol]
05 [NT Real COM      ] [ASPP   ] [Async Server Proprietary Protocol]
06 [Multi-Host TTY   ] [FIXTTY ] [Unix fixtty driver mode      ]
07 [NT Real COM      ] [ASPP   ] [Async Server Proprietary Protocol]
    
```

- The pop-up selector contains input/display fields for **Max. Sessions**, **Terminal model no.**, **Inactivity time**, **TCP alive check time**, and also **Session** parameters. Each item is described in detail below the figure.

```

+-----+
| Max. Sessions      : [ 8 ] |
| Terminal model no. : [VT100 ] |
| Inactivity time   : [ 0 ] minutes |
| TCP alive check time : [ 0 ] minutes |
| Session  Hot key  TCP port  Remote IP address |
| 1      [^A]      [4001 ]  [ ] |
| 2      [^B]      [5001 ]  [ ] |
| 3      [^E]      [6001 ]  [ ] |
| 4      [^F]      [7001 ]  [ ] |
| 5      [^T]      [8001 ]  [ ] |
| 6      [^U]      [9001 ]  [ ] |
| 7      [^V]      [10001 ] [ ] |
| 8      [^W]      [11001 ] [ ] |
+-----+
    
```

Setting	Value	Notes	Necessity
Max. Sessions	1-8	Select the maximum number of simultaneous sessions that will be allowed for this serial port.	Optional
Terminal mode no.	Star NT-560+, NL-5000A, VT100	CN2510 provides 3 modes that depend on the connection mode supported by the terminal.	Optional
Inactivity time	0-99 minutes	Idle time before the port is disconnected automatically. If set to 0 minutes, the port will not disconnect.	Optional
TCP alive check time	0-99 minutes	The time period CN2510 waits before checking if the TCP connection is alive or not. If no response is received, CN2510 will reset the port and terminate the connection.	Optional
Session Hot Key TCP port Remote IP		Configure the Hot key , TCP port , and Remote IP address for each session.	

3. Press **Esc** to return to the **PORT MENU**.

Configuring the Serial Ports

Open **Port Menu** → **Line** to configure serial port settings.

1. From the **MAIN MENU**, select **Port**, and then press **Enter**.

```

CN2510-8                CN2510-8_5631  V2.0                MAIN MENU
-----
Server [Port] seTting sAve Utility Restart Exit
Examine/modify async server ports configuration

Enter: select  ESC: previous menu

```

2. From the **PORT MENU**, select **Line**, and then press **Enter**.

```

CN2510-8                CN2510-8_5631  V2.0                PORT MENU
-----
Mode [Line] mOdem Welcome_MSG Quit
Examine/modify asynchronous port configuration

Enter: select  ESC: previous menu

```

- 3. The **Line** page has pop-up selection lists for **Port, Speed, Bits, Stop, Parity, FIFO, RTS/CTS, XON/XOFF, and Discon. ctrl** for each serial port. Each item is described in detail below the figure.

```

CN2510-8                      CN2510-8_5631  V2.0
-----
Mode [Line]  mModem Welcome_MSG Quit
Examine/modify asynchronous port configuration

ESC: back to menu  Enter:  select

Port  Speed   Bits  Stop   Parity  FIFO  RTS/CTS  XON/XOFF  Discon. ctrl
01  [115200] [8]  [ 1 ] [None ] [yes] [yes] [no ] [None ]
02  [115200] [8]  [ 1 ] [None ] [yes] [yes] [no ] [None ]
03  [115200] [8]  [ 1 ] [None ] [yes] [yes] [no ] [None ]
04  [115200] [8]  [ 1 ] [None ] [yes] [yes] [no ] [None ]
05  [115200] [8]  [ 1 ] [None ] [yes] [yes] [no ] [None ]
06  [115200] [8]  [ 1 ] [None ] [yes] [yes] [no ] [None ]
07  [115200] [8]  [ 1 ] [None ] [yes] [yes] [no ] [None ]
08  [115200] [8]  [ 1 ] [None ] [yes] [yes] [no ] [None ]

```

Setting	Value	Notes
Speed	50 bps to 921.6 Kbps	Transmission rate
Bits	5, 6, 7, 8	Data bits
Stop	1, 1.5, 2	Stop bits
Parity	None, Even, Odd, Mark, Space	Odd, Even, Mark, Space
FIFO	Yes, No	First In First Out Device
RTS/CTS	Yes, No	Hardware Flow Control
XON/XOFF	Yes, No	Software Flow Control
Discon. Ctrl	None	DSR off or DCD off will not be interpreted as a disconnection.
	DSR off	DSR off will be interpreted as a disconnection.
	DCD off	DCD off will be interpreted as a disconnection.

- 4. Press **ESC** to return to the **PORT MENU**.

Save

When exiting the **SERVER MENU**, you will be prompted to save settings. Press **Y** to save.

```

CN2510-8                      CN2510-8_5631  V2.0                      SERVER MENU
-----
Info. Lan Adv. Host_table Route_table [User_table] Quit
Examine/modify async server basic configuration

Enter: select  ESC: previous menu

+-----+
|                          Warning !!!                          |
|  You had modified the configuration without saving.            |
|  Would you save it now ?                                       |
|                        'Y': yes      'N': no                  |
+-----+

```

You may also save all settings from the **MAIN MENU** by selecting **sAve** and then pressing **Enter**. Press **Enter** again to save, and any other key to cancel.

```

CN2510-8          CN2510-8_5631  V2.0          MAIN MENU
-----
Server Port seTting [sAve] Utility Restart Exit
Save current configuration to Flash ROM
ESC: back to menu  Enter:  select

+-----+
|Enter to updated, other key to cancel|
+-----+
    
```

Restart

- From the **MAIN MENU**, select **Restart**.

```

CN2510-8          CN2510-8_5631  V2.0          MAIN MENU
-----
Server Port seTting sAve Utility [Restart] Exit
Restart the whole system or selected async ports
Enter: select  ESC: previous menu
    
```

- Select **System** and then press **Enter** to restart the system and terminate the Telnet session.

```

CN2510-8          CN2510-8_5631  V2.0
-----
[System] Port  Quit
Restart the Async Server
ESC: back to menu  Enter:  select

+-----+
|                               Warning !!!                               |
| Restart system will disconnect all ports and clear all status value |
|                               Enter: continue   ESC: cancel           |
+-----+
    
```

Setting up Hosts

Installing and Compiling Moxatty

Installing and Compiling

- Create a directory for Moxatty (e.g. /usr/etc/moxatty) as shown below:

```

#mkdir /usr/etc/moxatty
#cd /usr/etc/moxatty
    
```

- Extract code from the tar-formatted file `moxatty.tar` as follows:

```

#tar xvf moxatty.tar
    
```

- After the extraction is complete, locate the following files:

moxattyd.c	program source code
moxattyd.cf	configuration file
README	description file for moxatty

4. Compile and link documents:

SCO UNIX : cc -O -o moxattyd moxattyd.c -lsocket
LINUX : cc -O -o moxattyd moxattyd.c
AIX : cc -O -o -DAIX moxattyd moxattyd.c

Configuring tty Redirection

The following example illustrates how to map and redirect a tty device to a MOXA CN2510 serial port. Use **vi** or any other text editor to add or modify entries in the file `moxattyd.cf`. There are three columns: **Device Name**, **CN2510 IP address**, and **TCP port number** in the entry for the file `moxattyd.cf`.

Device Name	CN2510 IP address	TCP Port number
ttyp1	192.168.1.1	4001
ttyp2	192.168.1.1	4002
ttyp3	192.168.1.1	4003
ttyp4	192.168.1.1	4004

NOTE

1. Device Names for SCO Unix are ttyp0, ttyp1, ttyp2.
2. Device Names for Linux are tty[pqrs][0-9,a-f].
3. Device Names for AIX are tty p[0-9,a-f].
4. Default TCP port numbers are from 4001 to 4016 for the 16-port CN2510. If necessary, you can customize the TCP port numbers. However, the numbers you use **MUST** be the same as those defined in MOXA CN2510.

Adding Moxatty to system booting procedures

To include MOXATTY in the booting system, add the `moxattyd` daemon process to the `/etc/inittab` file. The following example illustrates how to add the full path name for `moxattyd` to the entries of `/etc/inittab` for different UNIX hosts.

For SCO UNIX

ts:2:respawn:/usr/etc/moxatty/moxattyd -t 1

For LINUX

ts:3:respawn:/usr/etc/moxatty/moxattyd -t 1

For AIX

ts:2:respawn:usr/etc/moxatty/moxattyd -t 1

NOTE

The option “-t 1” means the reconnection time is 1 minute after turning CN2510 on or off.

Moxatty for Different Applications

This section illustrates how to use MOXATTY with a number of different applications.

Terminal Access

To use terminal access, the process `getty` must be activated when the system boots up. To do this, add the following entries to the file `/etc/inittab`.

For SCO UNIX

```
ts1:234:respawn:/etc/getty ttyp1
ts2:234:respawn:/etc/getty ttyp2
ts3:234:respawn:/etc/getty ttyp3
ts4:234:respawn:/etc/getty ttyp4
```

For LINUX

```
p1:345:respawn:/sbin/mingetty ttyp1
p2:345:respawn:/sbin/mingetty ttyp2
p3:345:respawn:/sbin/mingetty ttyp3
p4:345:respawn:/sbin/mingetty ttyp4
```

For AIX

```
ts1:2:respawn:/usr/sbin/getty ttyp1
ts2:2:respawn:/usr/sbin/getty ttyp2
ts3:2:respawn:/usr/sbin/getty ttyp3
ts4:2:respawn:/usr/sbin/getty ttyp4
```

NOTE ttyp1 to ttyp4 device names are mapped to port 1 to port 4 on MOXA CN2510.

Transparent Printer Access

It's not necessary to add additional entries to `/etc/inittab` for printer access, as mentioned in the section on terminal access. Since MOXATTY is a fixed pseudo tty, you can easily connect a serial printer to a Moxa CN2510 serial port to execute printing commands.

The following example is for SCO UNIX:

Command	Description
<code>/usr/lib/lpadmin -pLaser1 -v/dev/ttyp1</code>	set printer name as Laser1 and use ttyp1
<code>/usr/lib/accept Laser1</code>	accept printer Laser1
<code>enable Laser1</code>	enable printer Laser1
<code>lp -dLaser1 file_name</code>	print file to Laser1

Other Applications

As mentioned earlier, the system setup depends on which application you are using. Since MOXATTY is a fixed pseudo tty, no additional setup is required to enable your applications to open tty devices.

Using Moxatty

Starting MOXATTY

Once you have completed the above settings, you can start. Follow the steps given below to ensure that MOXATTY is running correctly.

See if the entries added to `moxattyd.cf` are correct.

Run `init q` or reboot your system to start the MOXATTY daemon. If you see that `moxattyd` is running on your system, then MOXATTY has been successfully started.

Stopping MOXATTY

If for any reason you need to stop the MOXATTY daemon, the two methods listed below allow you to stop the `moxattyd` daemon process:

1. Remove entries related to `moxattyd` daemon in `/etc/inittab` and execute `init q` or reboot your system, or
2. Replace `respawn` with `off` in entries related to `moxattyd` daemon in `/etc/inittab`, and execute `init q` or reboot your system.

For instance, `'ts:2:off:/usr/etc/moxatty/moxattyd'` for SCO UNIX,
`'ts:3:off:/usr/etc/moxatty/moxattyd'` for LINUX, or `'ts:2:off:/usr/etc/moxatty/moxattyd'` for AIX.

10

Setting Up Dialin/out

In this chapter, we describe the steps required to configure Moxa CN2510 as a Dial-in/out Access Server. Dial-in Access allows remote users to access the LAN, whereas Dial-out Access allows LAN hosts to establish connections to other sites.

The following topics are covered in this chapter:

- Accessing the Console Utility**
- Selecting the Application**
- Configuring PPPD/PPP Mode**
- Configuring SLIPD/SLIP Mode**
- Configuring Dynamic Mode**
- Configuring the Serial Ports**
- Configuring Modem Initialization**
- Optional Welcome Message**
- Configuring Optional Local User Information**
- Save**
- Restart**

Accessing the Console Utility

NOTE In this section, we show how to access CN2510's console utility by Telnet over the network. For information on using the console port, see the section "Accessing the Console Utility" in Chapter 2.

1. Telnet over the network to the server's IP address.

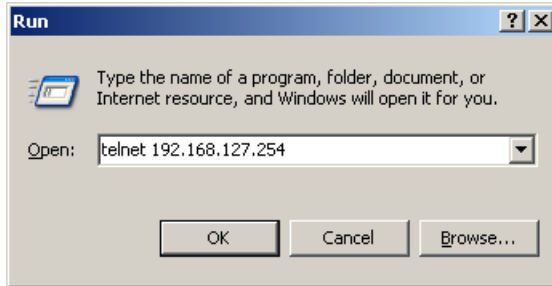

2. Type **1** to choose **ansi/vt100**, and then press **Enter**.

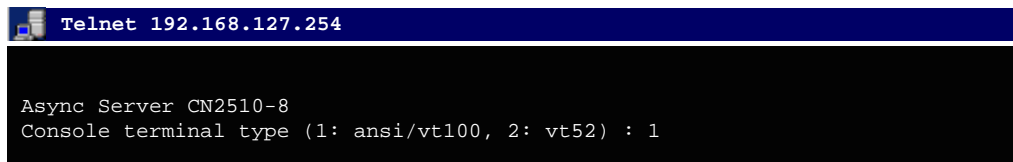

3. CN2510's **MAIN MENU** will open, as shown below.

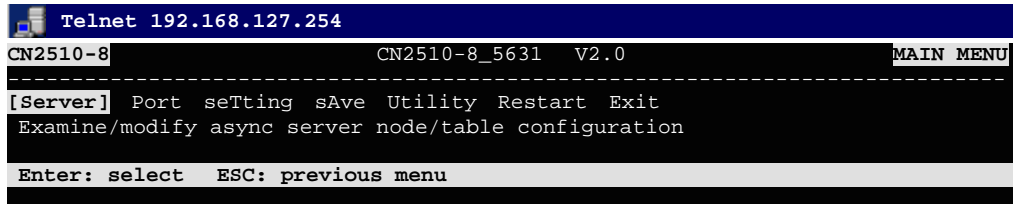

Use the following keystrokes to navigate CN2510's console utility.

Action	Key
Move	[Up/Down/Left/Right] Arrow Key or [Tab] Key
Jump to next menu, or Select item	[Enter] Key
Return to previous menu, or Close pop up selector	[Esc] Key
Shortcut Key	Capitalized letter of the word

Selecting the Application

Open **Port Menu** → **Mode** to configure the **Dial-up/out** application.

- From the **MAIN MENU**, select **Port**, and then press **Enter**.

```

CN2510-8                CN2510-8_5631  V2.0                MAIN MENU
-----
Server [Port] seTting sAve Utility Restart Exit
Examine/modify async server ports configuration
Enter: select  ESC: previous menu
    
```

- From the **PORT MENU**, select **Mode**, and then press **Enter**.

```

CN2510-8                CN2510-8_5631  V2.0                PORT MENU
-----
[Mode] Line mOdem Welcome_MSG Quit
Examine/modify the operation mode of async ports
Enter: select  ESC: previous menu
    
```

- The **Mode** page has pop-up selection lists for **Application**, **Mode**, and **Description/more setting** for each serial port. Use the arrow keys to move the cursor to the **Application** column for the port to be configured, and then press **Enter**. We use Port 6 to illustrate.

```

CN2510-8                CN2510-8_5631  V2.0
-----
[Mode] Line mOdem Welcome_MSG Quit
Examine/modify the operation mode of async ports
ESC: back to menu  Enter: select

Port Application          Mode          Description/more setting
01 [NT Real COM ] [ASPP ] [Async Server Proprietary Protocol]
02 [NT Real COM ] [ASPP ] [Async Server Proprietary Protocol]
03 [NT Real COM ] [ASPP ] [Async Server Proprietary Protocol]
04 [NT Real COM ] [ASPP ] [Async Server Proprietary Protocol]
05 [NT Real COM ] [ASPP ] [Async Server Proprietary Protocol]
06 [NT Real COM ] [ASPP ] [Async Server Proprietary Protocol]
07 [NT Real COM ] [ASPP ] [Async Server Proprietary Protocol]
08 [NT Real COM ] [ASPP ] [Async Server Proprietary Protocol]
    
```

- Use the up/down arrow keys to select **Dialin/out** mode, and then press **Enter**.

```

CN2510-8                CN2510-8_5631  V2.0
-----
[Mode] Line mOdem Welcome_MSG Quit
Examine/modify the operation mode of async ports
ESC: back to menu  Enter: select

Port Application          +-----+ption/more setting
01 [NT Real COM ] | Disable | Server Proprietary Protocol]
02 [NT Real COM ] | Dialin/out | Server Proprietary Protocol]
03 [NT Real COM ] | Terminal | Server Proprietary Protocol]
04 [NT Real COM ] | Reverse Terminal | Server Proprietary Protocol]
05 [NT Real COM ] | Device Control | Server Proprietary Protocol]
06 [NT Real COM ] | Multiplex | Server Proprietary Protocol]
07 [NT Real COM ] | Printer | Server Proprietary Protocol]
08 [NT Real COM ] | Multi-Host TTY | Server Proprietary Protocol]
    
```

- The Dialin/out application supports five operation modes: **DYNAMIC**, **PPP**, **PPPD**, **SLIP**, **SLIPD**. **DYNAMIC** mode is selected by default.

```

CN2510-8          CN2510-8_5631  V2.0
-----
[Mode] Line mOdem Welcome_MSG Quit
Examine/modify the operation mode of async ports

ESC: back to menu  Enter:  select

Port Application      Mode      Description/more setting
01 [NT Real COM      ] [ASPP   ] [Async Server Proprietary Protocol]
02 [NT Real COM      ] [ASPP   ] [Async Server Proprietary Protocol]
03 [NT Real COM      ] [ASPP   ] [Async Server Proprietary Protocol]
04 [NT Real COM      ] [ASPP   ] [Async Server Proprietary Protocol]
05 [NT Real COM      ] [ASPP   ] [Async Server Proprietary Protocol]
06 [Dialin/out       ] [DYNAMIC] [Auto Term/SLIP/PPP identification]
07 [NT Real COM      ] [ASPP   ] [Async Server Proprietary Protocol]
08 [NT Real COM      ] [ASPP   ] [Async Server Proprietary Protocol]
    
```

Configuring PPPD/PPP Mode

PPPD (PPP on demand) is used for dial-in services, since it provides PPP services only when receiving a request from a remote PC. PPP provides standard PPP services for both dial-in and dial-out.

- Move the cursor to the **Mode** column for the port and then press **Enter**.

```

CN2510-8          CN2510-8_5631  V2.0
-----
[Mode] Line mOdem Welcome_MSG Quit
Examine/modify the operation mode of async ports

ESC: back to menu  Enter:  select

Port Application      Mode      Description/more setting
01 [NT Real COM      ] [ASPP   ] [Async Server Proprietary Protocol]
02 [NT Real COM      ] [ASPP   ] [Async Server Proprietary Protocol]
03 [NT Real COM      ] [ASPP   ] [Async Server Proprietary Protocol]
04 [NT Real COM      ] [ASPP   ] [Async Server Proprietary Protocol]
05 [NT Real COM      ] [ASPP   ] [Async Server Proprietary Protocol]
06 [Dialin/out       ] [DYNAMIC] [Auto Term/SLIP/PPP identification]
07 [NT Real COM      ] [ASPP   ] [Async Server Proprietary Protocol]
08 [NT Real COM      ] [ASPP   ] [Async Server Proprietary Protocol]
    
```

- Select **PPPD** for dial-in services only, or **PPP** for both dial-in/out services.

```

CN2510-8          CN2510-8_5631  V2.0
-----
[Mode] Line mOdem Welcome_MSG Quit
Examine/modify the operation mode of async ports

ESC: back to menu  Enter:  select

Port Application      Mode      DYNAMIC  on/more setting
01 [NT Real COM      ] [ASPP   ] PPP      rver Proprietary Protocol]
02 [NT Real COM      ] [ASPP   ] PPPD     rver Proprietary Protocol]
03 [NT Real COM      ] [ASPP   ] SLIP     rver Proprietary Protocol]
04 [NT Real COM      ] [ASPP   ] SLIPD    rver Proprietary Protocol]
05 [NT Real COM      ] [ASPP   ] +-----+rver Proprietary Protocol]
06 [Dialin/out       ] [DYNAMIC] [Auto Term/SLIP/PPP identification]
07 [NT Real COM      ] [ASPP   ] [Async Server Proprietary Protocol]
08 [NT Real COM      ] [ASPP   ] [Async Server Proprietary Protocol]
    
```

3. Move the cursor to the **Description/more setting** column, and then press **Enter**.

```

CN2510-8          CN2510-8_5631  V2.0
-----
[Mode] Line mOdem Welcome_MSG Quit
Examine/modify the operation mode of async ports

ESC: back to menu  Enter:  select

Port Application      Mode      Description/more setting
01 [NT Real COM      ] [ASPP   ] [Async Server Proprietary Protocol]
02 [NT Real COM      ] [ASPP   ] [Async Server Proprietary Protocol]
03 [NT Real COM      ] [ASPP   ] [Async Server Proprietary Protocol]
04 [NT Real COM      ] [ASPP   ] [Async Server Proprietary Protocol]
05 [NT Real COM      ] [ASPP   ] [Async Server Proprietary Protocol]
06 [Dialin/out       ] [PPP    ] [Point-to-Point Protocol]
07 [NT Real COM      ] [ASPP   ] [Async Server Proprietary Protocol]
08 [NT Real COM      ] [ASPP   ] [Async Server Proprietary Protocol]
    
```

4. The pop-up selector contains input/display fields for **Destination IP addr**, **Source IP address**, **IP netmask**, **TCP/IP compression**, **Inactivity time**, **Link quality report**, **Outgoing PAP ID**, **PAP password**, and **Incoming PAP check**. Each item is described in detail below the figure.

```

-----+
Destination IP addr : [      ]
Source IP address  : [      ]
IP netmask         : [      ]
TCP/IP compression : [no  ]
Inactivity time    : [0  ] minutes
Link quality report : [no  ]
Outgoing PAP ID    : [      ]
PAP password       : [      ]
Incoming PAP check : [none ]
-----+
    
```

Setting	Value	Notes	Necessity
Destination IP addr	IP address for the remote Dial-in / Dial-out user	Assign an IP address for the remote user.	Required
Source IP address	IP address for the port	CN2510 will automatically assign an IP address for the port. We recommend leaving this space blank.	Optional
IP netmask	IP netmask	CN2510 automatically assigns the netmask 255.255.255.255. We recommend leaving this space blank.	Optional
TCP/IP compression	Yes/No	Depends on whether the remote user's application requests compression.	Optional
Inactivity time	0-99 minutes	Idle time before the port is disconnected automatically. If set to 0 minutes, the port will not disconnect.	Optional
Link quality report	Yes/No	If you are using software to collect Link quality information, choose YES.	Optional
Outgoing PAP ID	ID	Dial out user/account ID information	Optional
PAP password	Password	Dial out user/account password	Optional

Setting	Value	Notes	Necessity
Incoming PAP check	None/local/server	<p>None: Authentication is not required.</p> <p>local: Check the ID stored in the User_table (defined under the SERVER MENU). You will need to configure the user's information later in this chapter.</p> <p>Server: Check the ID with the external RADIUS server. Refer to Appendix C for RADIUS installation information.</p>	Optional

5. Press **Esc** to return to the **PORT MENU**.

Configuring SLIPD/SLIP Mode

Moxa CN2510 supports SLIP (Serial Line Internet Protocol), and SLIPD (for Dial-in services only).

1. Move the cursor to the **Mode** column for the port and then press **Enter**.

```

CN2510-8                CN2510-8_5631  V2.0
-----
[Mode] Line mOdem Welcome_MSG Quit
Examine/modify the operation mode of async ports

ESC: back to menu  Enter: select

Port Application          Mode          Description/more setting
01 [NT Real COM          ] [ASPP       ] [Async Server Proprietary Protocol]
02 [NT Real COM          ] [ASPP       ] [Async Server Proprietary Protocol]
03 [NT Real COM          ] [ASPP       ] [Async Server Proprietary Protocol]
04 [NT Real COM          ] [ASPP       ] [Async Server Proprietary Protocol]
05 [NT Real COM          ] [ASPP       ] [Async Server Proprietary Protocol]
06 [Dialin/out           ] [DYNAMIC    ] [Auto Term/SLIP/PPP identification]
07 [NT Real COM          ] [ASPP       ] [Async Server Proprietary Protocol]
08 [NT Real COM          ] [ASPP       ] [Async Server Proprietary Protocol]
    
```

2. Select **SLIPD** for dial-in services only, or **SLIP** for both dial-in/out services.

```

CN2510-8                CN2510-8_5631  V2.0
-----
[Mode] Line mOdem Welcome_MSG Quit
Examine/modify the operation mode of async ports

ESC: back to menu  Enter: select

Port Application          Mode          +-----+
01 [NT Real COM          ] [ASPP       ] | DYNAMIC | on/more setting
02 [NT Real COM          ] [ASPP       ] | PPP     | rver Proprietary Protocol]
03 [NT Real COM          ] [ASPP       ] | PPPD    | rver Proprietary Protocol]
04 [NT Real COM          ] [ASPP       ] | SLIP    | rver Proprietary Protocol]
05 [NT Real COM          ] [ASPP       ] | SLIPD   | rver Proprietary Protocol]
06 [Dialin/out           ] [DYNAMIC    ] |         | [Auto Term/SLIP/PPP identification]
07 [NT Real COM          ] [ASPP       ] |         | [Async Server Proprietary Protocol]
08 [NT Real COM          ] [ASPP       ] |         | [Async Server Proprietary Protocol]
    
```

3. Move the cursor to the **Description/more setting** column, and then press **Enter**.

```

CN2510-8                CN2510-8_5631  V2.0
-----
[Mode] Line mOdem Welcome_MSG Quit
Examine/modify the operation mode of async ports

ESC: back to menu  Enter: select

Port  Application          Mode          Description/more setting
01   [NT Real COM          ] [ASPP        ] [Async Server Proprietary Protocol]
02   [NT Real COM          ] [ASPP        ] [Async Server Proprietary Protocol]
03   [NT Real COM          ] [ASPP        ] [Async Server Proprietary Protocol]
04   [NT Real COM          ] [ASPP        ] [Async Server Proprietary Protocol]
05   [NT Real COM          ] [ASPP        ] [Async Server Proprietary Protocol]
06   [Dialin/out           ] [SLIP        ] [Serial Line Internet Protocol]
07   [NT Real COM          ] [ASPP        ] [Async Server Proprietary Protocol]
08   [NT Real COM          ] [ASPP        ] [Async Server Proprietary Protocol]
    
```

4. The pop-up selector contains input/display fields for **Destination IP addr**, **Source IP address**, **IP netmask**, **TCP/IP compression**, **Inactivity time**, **Link quality report**, **Outgoing PAP ID**, **PAP password**, and **Incoming PAP check**. Each item is described in detail below the figure.

```

+-----+
| Destination IP addr  : [          ] |
| Source IP address   : [          ] |
| IP netmask          : [          ] |
| TCP/IP compression  : [no  ]     |
| Inactivity time     : [0  ] minutes |
| Link quality report : [no  ]     |
| Outgoing PAP ID    : [          ] |
| PAP password       : [          ] |
| Incoming PAP check  : [none  ]    |
+-----+
    
```

Setting	Value	Notes	Necessity
Destination IP addr	IP address for the remote Dial-in / Dial-out user	Assign an IP address for the remote user.	Required
Source IP address	IP address for the port	CN2510 will automatically assign an IP address for the port. We recommend leaving this space blank.	Optional
IP netmask	IP netmask	CN2510 automatically assigns the netmask 255.255.255.255. We recommend leaving this space blank.	Optional
TCP/IP compression	Yes/No	Depends on whether the remote user's application requests compression.	Optional
Inactivity time	0-99 minutes	Idle time before the port is disconnected automatically. If set to 0 minutes, the port will not disconnect.	Optional
Link quality report	Yes/No	If you are using software to collect Link quality information, choose YES.	Optional
Outgoing PAP ID	ID	Dial out user/account ID information	Optional
PAP password	Password	Dial out user/account password	Optional

Setting	Value	Notes	Necessity
Incoming PAP check	None/local/server	<p>None: Authentication is not required.</p> <p>local: Check the ID stored in the User_table (defined under the SERVER MENU). You will need to configure the user's information later in this chapter.</p> <p>Server: Check the ID with the external RADIUS server. Refer to Appendix C for RADIUS installation information.</p>	Optional

5. Press **Esc** to return to the **PORT MENU**.

Configuring Dynamic Mode

Dynamic mode integrates PPPD, SLIPD, and Terminal dial-in services. Dynamic mode automatically detects which remote connection mode is being used, and provides corresponding services. You can further enable/disable PPP/SLIP/Terminal services by using the **Description/more setting** pop-ups.

1. Move the cursor to the **Mode** column for the port and then press **Enter**.

```

CN2510-8                CN2510-8_5631  V2.0
-----
[Mode] Line mOdem Welcome_MSG Quit
Examine/modify the operation mode of async ports

ESC: back to menu  Enter:  select

Port  Application          Mode          Description/more setting
01  [NT Real COM ] [ASPP ] [Async Server Proprietary Protocol]
02  [NT Real COM ] [ASPP ] [Async Server Proprietary Protocol]
03  [NT Real COM ] [ASPP ] [Async Server Proprietary Protocol]
04  [NT Real COM ] [ASPP ] [Async Server Proprietary Protocol]
05  [NT Real COM ] [ASPP ] [Async Server Proprietary Protocol]
06  [Dialin/out ] [DYNAMIC ] [Auto Term/SLIP/PPP identification]
07  [NT Real COM ] [ASPP ] [Async Server Proprietary Protocol]
08  [NT Real COM ] [ASPP ] [Async Server Proprietary Protocol]
    
```

2. Select **DYNAMIC** for dial-in/out services.

```

CN2510-8                CN2510-8_5631  V2.0
-----
[Mode] Line mOdem Welcome_MSG Quit
Examine/modify the operation mode of async ports

ESC: back to menu  Enter:  select

Port  Application          Mode          +-----+
01  [NT Real COM ] [ASPP ] | DYNAMIC | on/more setting
02  [NT Real COM ] [ASPP ] | PPP    | rver Proprietary Protocol]
03  [NT Real COM ] [ASPP ] | PPPD   | rver Proprietary Protocol]
04  [NT Real COM ] [ASPP ] | SLIP   | rver Proprietary Protocol]
05  [NT Real COM ] [ASPP ] | SLIPD  | rver Proprietary Protocol]
06  [Dialin/out ] [DYNAMIC ] | +-----+ | rver Proprietary Protocol]
07  [NT Real COM ] [ASPP ] | [Auto Term/SLIP/PPP identification]
08  [NT Real COM ] [ASPP ] | [Async Server Proprietary Protocol]
    
```

3. Move the cursor to the **Description/more setting** column, and then press **Enter**.

```

CN2510-8                CN2510-8_5631  V2.0
-----
[Mode] Line mOdem Welcome_MSG Quit
Examine/modify the operation mode of async ports

ESC: back to menu  Enter:  select

Port  Application          Mode          Description/more setting
01   [NT Real COM          ] [ASPP       ] [Async Server Proprietary Protocol]
02   [NT Real COM          ] [ASPP       ] [Async Server Proprietary Protocol]
03   [NT Real COM          ] [ASPP       ] [Async Server Proprietary Protocol]
04   [NT Real COM          ] [ASPP       ] [Async Server Proprietary Protocol]
05   [NT Real COM          ] [ASPP       ] [Async Server Proprietary Protocol]
06   [Dialin/out           ] [DYNAMIC    ] [Auto Term/SLIP/PPP identification]
07   [NT Real COM          ] [ASPP       ] [Async Server Proprietary Protocol]
08   [NT Real COM          ] [ASPP       ] [Async Server Proprietary Protocol]
    
```

4. The pop-up selector contains input/display fields for **TERM_BIN mode**, **PPPD mode**, and **SLIPD mode**. Each item is described in detail below the figure.

```

+-----+
| Enable  | Detail setting | |
| TERM_BIN mode  | [yes]         | [Term parameters  ] |
| PPPD mode      | [yes]         | [PPP parameters   ] |
| SLIPD mode     | [yes]         | [SLIP parameters  ] |
+-----+
| Authentication type | [local  ] |
+-----+
    
```

Setting	Value	Notes	Necessity
TERM_BIN mode	yes/no	Select yes to enable a Binary Terminal connection	Optional
PPPD mode	yes/no	Select yes to enable a PPPD connection	Optional
SLIPD mode	yes/no	Select yes to enable a SLIPD Terminal connection	Optional
Authentication type	None/ local/ server	None: Authentication is not required. local: Check the ID stored in the User_table (defined under the SERVER MENU). Server: Check the ID with the external RADIUS server. Refer to Appendix C for RADIUS installation information.	Optional

5. To configure the **TERM_BIN mode** parameters, move the cursor to the Detail setting column to highlight **Description/more setting**, and then press **Enter**.

```

+-----+
| Enable  | Detail setting | |
| TERM_BIN mode  | [yes]         | [Term parameters  ] |
| PPPD mode      | [yes]         | [PPP parameters   ] |
| SLIPD mode     | [yes]         | [SLIP parameters  ] |
+-----+
| Authentication type | [none  ] |
+-----+
    
```

6. The pop-up selector contains input/display fields for **Quit key**, **Auto-link protocol**, **Link by input IP**, **Auto-login prompt**, **Terminal type**, **Inactivity time**, **Authentication type**, and **TCP alive check time**. Each item is described in detail below the figure.

```

Quit key           : [^E]
Auto-link protocol : [none  ]
  Telnet TCP port  : [23   ]
  Primary host IP  : [      ]
Link by input IP   : [Disable]
  Secondary host IP : [      ]
Auto-login prompt  : [ogin:  ]
Password prompt    : [assword:]
Login user name    : [      ]
Login password     : [      ]
Terminal type      : [ansi   ]
Inactivity time    : [0   ] minutes
Authentication type : [none  ]
TCP alive check time : [0   ] minutes
    
```

Setting	Value	Notes	Necessity
Quit Key	^E	Defines the Quit key used to disconnect the link between the current terminal session and the remote host. It may be left blank for binary communication.	Optional
Auto-link protocol	None/Telnet/Rlogin	None: Do not connect to the host automatically. Telnet: Connects to the host automatically by Telnet. Rlogin: Connects to the host automatically by Rlogin.	Optional
Telnet TCP port	23	By default, the Telnet TCP port number is set to 23, which is the default TCP port number for Telnet. If you need to telnet to this CN2510 serial port, set the Telnet TCP port to a different number. We recommend using 4001, 4002, etc. for ports 1, 2, etc. to avoid conflicts with other ports.	Optional
Primary host IP	IP address or the name defined in the [Host] table	If specified, designates a 'permanent' host to which the terminal will always be connected.	Optional
Link by input IP	Enable/Disable	For users to enter the connection IP address manually.	Optional
Secondary host IP	IP address or the name defined in the [Host] table.	If specified, designates a secondary 'permanent' host to which the terminal will be connected.	Optional
Auto-login prompt	ogin:	Send ID information when this prompt is received.	Optional

Setting	Value	Notes	Necessity
Password prompt	assword:	Send Password information when this prompt is received	Optional
Login user name		Login ID	Optional
Login password		Login Password	Optional
Terminal type	ansi	Terminal type for outgoing connection	Optional
Inactivity time	0-99 minutes	Idle time before the port is disconnected automatically. If set to 0 minutes, the port will not disconnect.	Optional
Authentication type	None/local/server	None: Authentication is not required. local: Check the ID stored in the User_table (defined under the SERVER MENU). Server: Check the ID with the external RADIUS server. Refer to Appendix C for RADIUS installation information.	Optional
TCP alive check time	0-99 minutes	The time period CN2510 waits before checking if the TCP connection is alive or not. If no response is received, CN2510 will reset the port and terminate the connection.	Optional

- To configure the **PPPD** mode parameters, move the cursor to the Detail setting column to highlight **PPP parameters**, and then press **Enter**.

```

+-----+
| Enable  Detail setting |
| TERM_BIN mode [yes] [Term parameters ] |
| PPPD mode [yes] [PPP parameters ] |
| SLIPD mode [yes] [SLIP parameters ] |
+-----+
| Authentication type [none ] |
+-----+
    
```

- The pop-up selector contains input/display fields for **Destination IP addr**, **Source IP address**, **IP netmask**, **TCP/IP compression**, **Inactivity time**, **Link quality report**, **Outgoing PAP ID**, and, **PAP password**. Each item is described in detail below the figure.

```

+-----+
| Destination IP address : [          ] |
| Source IP address     : [          ] |
| IP netmask            : [          ] |
| TCP/IP compression   : [no ] |
| Inactivity time      : [0 ] minutes |
| Link quality report   : [no ] |
| Outgoing PAP ID      : [          ] |
| PAP password         : [          ] |
+-----+
    
```

Setting	Value	Notes	Necessity
Destination IP addr	IP address for the remote Dial-in / Dial-out user	You need to assign an IP address for the remote user.	Required

Setting	Value	Notes	Necessity
Source IP address	IP address for the port	CN2510 will automatically assign an IP address for the port. We recommend leaving this space blank.	Optional
IP netmask	IP netmask	CN2510 automatically assigns the netmask 255.255.255.255. We recommend leaving this space blank.	Optional
TCP/IP compression	Yes/No	Depends on whether the remote user's application requests compression.	Optional
Inactivity time	0-99 minutes	Idle time before the port is disconnected automatically. If set to 0 minutes, the port will not disconnect.	Optional
Link quality report	Yes/No	If you are using software to collect Link quality information, choose YES.	Optional
Outgoing PAP ID	ID	Dial out user/account ID information	Optional
PAP password	Password	Dial out user/account password	Optional

9. To configure the **SLIPD** mode parameters, move the cursor to the Detail setting column to highlight **SLIP parameters**, and then press **Enter**.

```

+-----+
| Enable | Detail setting |
| TERM_BIN mode [yes] [Term parameters ] |
| PPPD mode [yes] [PPP parameters ] |
| SLIPD mode [yes] [SLIP parameters ] |
+-----+
| Authentication type [none ] |
+-----+
    
```

10. The pop-up selector contains input/display fields for **Destination IP addr**, **Source IP address**, **IP netmask**, **TCP/IP compression**, and **Inactivity time**. Each item is described in detail below the figure.

```

+-----+
| Destination IP address : [ ] |
| Source IP address : [ ] |
| IP netmask : [ ] |
| TCP/IP compression : [no ] |
| Inactivity time : [0 ] minutes |
+-----+
    
```

Setting	Value	Notes	Necessity
Destination IP addr	IP address for the remote Dial-in / Dial-out user	You need to assign an IP address for the remote user.	Required
Source IP address	IP address for the port	CN2510 will automatically assign an IP address for the port. We recommend leaving this space blank.	Optional
IP netmask	IP netmask	CN2510 automatically assigns the netmask 255.255.255.255. We recommend leaving this space blank.	Optional

Setting	Value	Notes	Necessity
TCP/IP compression	Yes/No	Depends on whether the remote user's application requests compression.	Optional
Inactivity time	0-99 minutes	Idle time before the port is disconnected automatically. If set to 0 minutes, the port will not disconnect.	Optional

11. Press **Esc** to return to the **PORT MENU**.

Configuring the Serial Ports

Open **Port Menu** → **Line** to configure serial port settings.

1. From the **MAIN MENU**, select **Port**, and then press **Enter**.

```

CN2510-8                      CN2510-8_5631  V2.0                      MAIN MENU
-----
Server [Port] seTting sAve Utility Restart Exit
Examine/modify async server ports configuration

Enter: select  ESC: previous menu
    
```

2. From the **PORT MENU**, select **Line**, and then press **Enter**.

```

CN2510-8                      CN2510-8_5631  V2.0                      PORT MENU
-----
Mode [Line] mOdem Welcome_MSG Quit
Examine/modify asynchronous port configuration

Enter: select  ESC: previous menu
    
```

3. The **Line** page has pop-up selection lists for **Port**, **Speed**, **Bits**, **Stop**, **Parity**, **FIFO**, **RTS/CTS**, **XON/XOFF**, and **Discon. ctrl** for each serial port. Each item is described in detail below the figure.

```

CN2510-8                      CN2510-8_5631  V2.0
-----
Mode [Line] mOdem Welcome_MSG Quit
Examine/modify asynchronous port configuration

ESC: back to menu  Enter: select

Port  Speed  Bits  Stop  Parity  FIFO  RTS/CTS  XON/XOFF  Discon. ctrl
01  [115200] [8]  [ 1 ] [None ] [yes]  [yes]  [no ]  [None ]
02  [115200] [8]  [ 1 ] [None ] [yes]  [yes]  [no ]  [None ]
03  [115200] [8]  [ 1 ] [None ] [yes]  [yes]  [no ]  [None ]
04  [115200] [8]  [ 1 ] [None ] [yes]  [yes]  [no ]  [None ]
05  [115200] [8]  [ 1 ] [None ] [yes]  [yes]  [no ]  [None ]
06  [115200] [8]  [ 1 ] [None ] [yes]  [yes]  [no ]  [None ]
07  [115200] [8]  [ 1 ] [None ] [yes]  [yes]  [no ]  [None ]
08  [115200] [8]  [ 1 ] [None ] [yes]  [yes]  [no ]  [None ]
    
```

Setting	Value	Notes
Speed	50 bps to 921.6 Kbps	Transmission rate
Bits	5, 6, 7, 8	Data bits
Stop	1, 1.5, 2	Stop bits
Parity	None, Even, Odd, Mark, Space	Odd, Even, Mark, Space
FIFO	Yes, No	First In First Out Device

Setting	Value	Notes
RTS/CTS	Yes, No	Hardware Flow Control
XON/XOFF	Yes, No	Software Flow Control
Discon. Ctrl	None	DSR off or DCD off will not be interpreted as a disconnection.
	DSR off	DSR off will be interpreted as a disconnection.
	DCD off	DCD off will be interpreted as a disconnection.

4. Press **ESC** to return to the **PORT MENU**.

Configuring Modem Initialization

Open **Port Menu** → **Modem** to configure modem dial-out initialization and dial-out phone numbers.

1. From the **MAIN MENU**, use the arrow keys to select **Port**, and then press **Enter**.

```

CN2510-8                      CN2510-8_5631  V2.0                      MAIN MENU
-----
Server [Port] seTting sAve Utility Restart Exit
Examine/modify async server ports configuration
Enter: select  ESC: previous menu
    
```

2. From the **PORT MENU**, select **mOdem**, and then press **Enter**.

```

CN2510-8                      CN2510-8_5631  V2.0                      PORT MENU
-----
Mode Line [mOdem] Welcome_MSG Quit
Modem initialization and dial-out setting
Enter: select  ESC: previous menu
    
```

3. The **Modem** page has input/display fields for **Enable**, **Initialize**, **Dialup**, and **Phone number** for each serial port. Each item is described in detail below the figure.

```

CN2510-8                      CN2510-8_5631  V2.0                      PORT MENU
-----
Mode Line [mOdem] Welcome_MSG Quit
Modem initialization and dial-out setting
ESC: back to menu  Enter: select
+-----+
Port  Enabl| no |ialize           Dial Up           Phone Number
01   [yes]| yes |                ] [ATD ] [          ]
02   [no ]+-----+                ] [ATD ] [          ]
03   [no ] [AT ]                ] [ATD ] [          ]
04   [no ] [AT ]                ] [ATD ] [          ]
05   [no ] [AT ]                ] [ATD ] [          ]
06   [no ] [AT ]                ] [ATD ] [          ]
07   [no ] [AT ]                ] [ATD ] [          ]
08   [no ] [AT ]                ] [ATD ] [          ]
    
```

- From the **SERVER MENU**, select **User_table**, and then press **Enter**.

```

CN2510-8                               CN2510-8_5631  V2.0                               SERVER MENU
-----
Info. Lan Adv. Host_table Route_table [User_table] Quit
Examine/modify the user/password table

Enter: select  ESC: previous menu
    
```

- The **User_table** page has input fields for **User name**, **Password**, and **Phone Number**, for each serial port. Input a Phone Number to activate the automatic call back function. Note that CN2510 can store information for up to 64 users.

```

CN2510-8                               CN2510-8_5631  V2.0                               SERVER MENU
-----
Info. Lan Adv. Host_table Route_table [User_table] Quit
Examine/modify the user/password table

ESC: back to menu  Enter: select

Entry   User name           Password           Phone Number
01      [                   ] [                   ] [                   ]
02      [                   ] [                   ] [                   ]
03      [                   ] [                   ] [                   ]
04      [                   ] [                   ] [                   ]
05      [                   ] [                   ] [                   ]
    
```

- Press **Esc** to return to the **MAIN MENU**.

Save

When exiting the **SERVER MENU**, you will be prompted to save settings. Press **Y** to save.

```

CN2510-8                               CN2510-8_5631  V2.0                               SERVER MENU
-----
Info. Lan Adv. Host_table Route_table [User_table] Quit
Examine/modify async server basic configuration

Enter: select  ESC: previous menu

+-----+
|                               |
|                               |
|      Warning !!!             |
|      You had modified the    |
|      configuration without    |
|      saving.                  |
|      Would you save it now ?  |
|      'Y': yes      'N': no    |
|                               |
+-----+
    
```

You may also save all settings from the **MAIN MENU** by selecting **sAve** and then pressing **Enter**. Press **Enter** again to save, and any other key to cancel.

```

CN2510-8                               CN2510-8_5631  V2.0                               MAIN MENU
-----
Server Port seTting [sAve] Utility Restart Exit
Save current configuration to Flash ROM

ESC: back to menu  Enter: select

+-----+
|                               |
|      Enter to updated, other  |
|      key to cancel            |
|                               |
+-----+
    
```

In this chapter, we describe how to set up Moxa CN2510 as a printer server. Up to 16 serial printers can be connected simultaneously to one CN2510. At the end of the chapter, the settings needed for one-port parallel printing is illustrated for both UNIX and Windows systems.

The following topics are covered in this chapter:

- Accessing the Console Utility**
- Selecting the Application**
- Configuring RAW PRN Mode**
- Configuring LPD PRN Mode**
- Configuring the Serial Ports**
- Save**
- Restart**
- Setting up Unix Hosts**
 - Setting up a SCO Unix Host
 - Setting up a SOLARIS X86 Host
 - Setting up a LINUX Host
- Setting up Windows Hosts**
 - Setting up a Windows NT Host
 - Setting up a Windows 2000 Host

Accessing the Console Utility

NOTE In this section, we show how to access CN2510's console utility by Telnet over the network. For information on using the console port, see the section "Accessing the Console Utility" in Chapter 2.

1. Telnet over the network to the server's IP address.

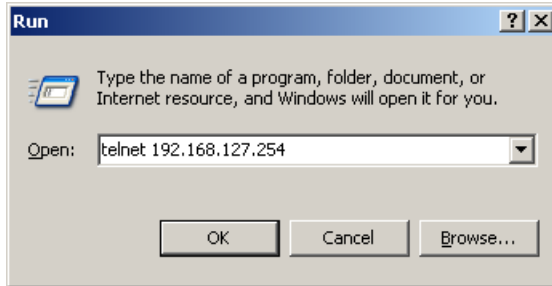

2. Type **1** to choose **ansi/vt100**, and then press **Enter**.

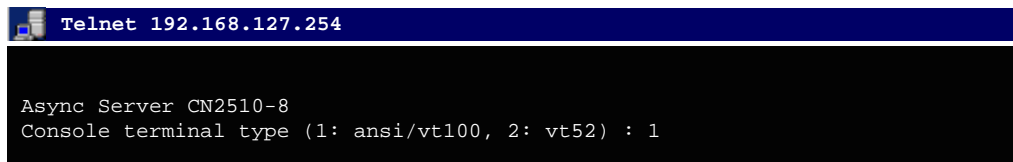

3. CN2510's **MAIN MENU** will open, as shown below.

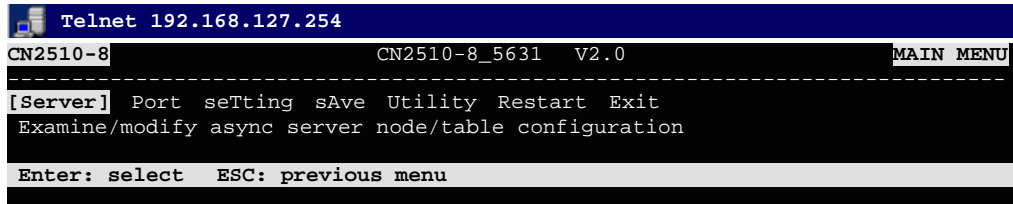

Use the following keystrokes to navigate CN2510's console utility.

Action	Key
Move	[Up/Down/Left/Right] Arrow Key or [Tab] Key
Jump to next menu, or Select item	[Enter] Key
Return to previous menu, or Close pop up selector	[Esc] Key
Shortcut Key	Capitalized letter of the word

Selecting the Application

Open **Port Menu** → **Mode** to set up the **Printer** application.

- From the **MAIN MENU**, select **Port**, and then press **Enter**.

```

CN2510-8                      CN2510-8_5631  V2.0                      MAIN MENU
-----
Server [Port] seTting sAve Utility Restart Exit
Examine/modify async server ports configuration

Enter: select  ESC: previous menu
    
```

- From the **PORT MENU**, select **Mode**, and then press **Enter**.

```

CN2510-8                      CN2510-8_5631  V2.0                      PORT MENU
-----
[Mode] Line mOdem Welcome_MSG Quit
Examine/modify the operation mode of async ports

Enter: select  ESC: previous menu
    
```

- The **Mode** page has pop-up selection lists for **Application**, **Mode**, and **Description/more setting** for each serial port. Use the arrow keys to move the cursor to the **Application** column for the port to be configured, and then press **Enter**. We use Port 6 to illustrate.

```

CN2510-8                      CN2510-8_5631  V2.0
-----
[Mode] Line mOdem Welcome_MSG Quit
Examine/modify the operation mode of async ports

ESC: back to menu  Enter: select

Port  Application          Mode          Description/more setting
01   [NT Real COM ] [ASPP ] [Async Server Proprietary Protocol]
02   [NT Real COM ] [ASPP ] [Async Server Proprietary Protocol]
03   [NT Real COM ] [ASPP ] [Async Server Proprietary Protocol]
04   [NT Real COM ] [ASPP ] [Async Server Proprietary Protocol]
05   [NT Real COM ] [ASPP ] [Async Server Proprietary Protocol]
06   [NT Real COM ] [ASPP ] [Async Server Proprietary Protocol]
07   [NT Real COM ] [ASPP ] [Async Server Proprietary Protocol]
    
```

- Use the up/down arrow keys to select **Printer**, and then press **Enter** to confirm.

```

CN2510-8                      CN2510-8_5631  V2.0
-----
[Mode] Line mOdem Welcome_MSG Quit
Examine/modify the operation mode of async ports

ESC: back to menu  Enter: select

Port  Application          +-----+ption/more setting
01   [Dialin/out ] | Disable | Term/SLIP/PPP identification]
02   [Dialin/out ] | Dialin/out | Term/SLIP/PPP identification]
03   [Dialin/out ] | Terminal | Term/SLIP/PPP identification]
04   [Dialin/out ] | Reverse Terminal | Term/SLIP/PPP identification]
05   [Dialin/out ] | Device Control | Term/SLIP/PPP identification]
06   [Dialin/out ] | Multiplex | Term/SLIP/PPP identification]
07   [Dialin/out ] | Printer | Term/SLIP/PPP identification]
08   [Dialin/out ] | Multi-Host TTY | Term/SLIP/PPP identification]
      | NT Real COM |
      | DRDAS |
      | Raw UDP |
      |-----+
    
```

- The Dialin/out application supports two operation modes: **RAW PRN** and **LPD PRN**. RAW PRN mode is selected by default.

```

CN2510-8          CN2510-8_5631  V2.0
-----
[Mode] Line mOdem Welcome_MSG Quit
Examine/modify the operation mode of async ports

ESC: back to menu  Enter:  select

Port Application      Mode      Description/more setting
01 [NT Real COM      ] [ASPP   ] [Async Server Proprietary Protocol]
02 [NT Real COM      ] [ASPP   ] [Async Server Proprietary Protocol]
03 [NT Real COM      ] [ASPP   ] [Async Server Proprietary Protocol]
04 [NT Real COM      ] [ASPP   ] [Async Server Proprietary Protocol]
05 [NT Real COM      ] [ASPP   ] [Async Server Proprietary Protocol]
06 [Printer           ] [RAW PRN] [Raw serial port printer mode      ]
07 [NT Real COM      ] [ASPP   ] [Async Server Proprietary Protocol]
    
```

Configuring RAW PRN Mode

- Move the cursor to the **Mode** column for the port and then press **Enter**.

```

CN2510-8          CN2510-8_5631  V2.0
-----
[Mode] Line mOdem Welcome_MSG Quit
Examine/modify the operation mode of async ports

ESC: back to menu  Enter:  select

Port Application      Mode      Description/more setting
01 [NT Real COM      ] [ASPP   ] [Async Server Proprietary Protocol]
02 [NT Real COM      ] [ASPP   ] [Async Server Proprietary Protocol]
03 [NT Real COM      ] [ASPP   ] [Async Server Proprietary Protocol]
04 [NT Real COM      ] [ASPP   ] [Async Server Proprietary Protocol]
05 [NT Real COM      ] [ASPP   ] [Async Server Proprietary Protocol]
06 [Printer           ] [RAW PRN] [Raw serial port printer mode      ]
07 [NT Real COM      ] [ASPP   ] [Async Server Proprietary Protocol]
    
```

- Select **RAW PRN**, and then press **Enter**.

```

CN2510-8          CN2510-8_5631  V2.0
-----
[Mode] Line mOdem Welcome_MSG Quit
Examine/modify the operation mode of async ports

ESC: back to menu  Enter:  select

Port Application      Mode      Description/more setting
01 [NT Real COM      ] [ASPP   ] [Async Server Proprietary Protocol]
02 [NT Real COM      ] [ASPP   ] [Async Server Proprietary Protocol]
03 [NT Real COM      ] [ASPP   ] [Async Server Proprietary Protocol]
04 [NT Real COM      ] [ASPP   ] +-----+rver Proprietary Protocol]
05 [NT Real COM      ] [ASPP   ] | RAW PRN |rver Proprietary Protocol]
06 [Printer           ] [RAW PRN] | LPD PRN |al port printer mode      ]
07 [NT Real COM      ] [ASPP   ] +-----+rver Proprietary Protocol]
08 [NT Real COM      ] [ASPP   ] [Async Server Proprietary Protocol]
    
```

3. Move the cursor to the **Description/more setting** column, and then press **Enter**.

```

CN2510-8          CN2510-8_5631  V2.0
-----
[Mode] Line mOdem Welcome_MSG Quit
Examine/modify the operation mode of async ports

ESC: back to menu  Enter:  select

Port Application      Mode      Description/more setting
01 [NT Real COM      ] [ASPP   ] [Async Server Proprietary Protocol]
02 [NT Real COM      ] [ASPP   ] [Async Server Proprietary Protocol]
03 [NT Real COM      ] [ASPP   ] [Async Server Proprietary Protocol]
04 [NT Real COM      ] [ASPP   ] [Async Server Proprietary Protocol]
05 [NT Real COM      ] [ASPP   ] [Async Server Proprietary Protocol]
06 [Printer          ] [RAW PRN] [Raw serial port printer mode      ]
07 [NT Real COM      ] [ASPP   ] [Async Server Proprietary Protocol]
    
```

4. The pop-up selector contains input/display fields for **Group**, **TCP Pcort number**, and **TCP alive check time**. Each item is described in detail below the figure.

```

+-----+
| Group           : [Group01] |
| TCP port number : [2048]   |
| TCP alive check time: [0 ] minutes |
+-----+
    
```

Setting	Value	Notes	Necessity												
Group	Group 01-16	Groups printers attached to different ports. Printers in the same group will share the printing load for printing requests to that group of printers. E.g., setting CN2510's serial ports 1, 3, and 6 for Group01 will allow the printers attached to these three ports to act essentially as one printer.	Optional												
TCP port number	2048-2063	The host uses this value to determine which Group the printer attached to this serial port belongs to. These values are fixed, and cannot be changed by the user. <table border="1" style="margin-left: auto; margin-right: auto;"> <thead> <tr> <th>Group</th> <th>TCP Port No.</th> </tr> </thead> <tbody> <tr> <td>01</td> <td>2048</td> </tr> <tr> <td>02</td> <td>2049</td> </tr> <tr> <td>03</td> <td>2050</td> </tr> <tr> <td>...</td> <td>...</td> </tr> <tr> <td>16</td> <td>2063</td> </tr> </tbody> </table>	Group	TCP Port No.	01	2048	02	2049	03	2050	16	2063	Fixed
Group	TCP Port No.														
01	2048														
02	2049														
03	2050														
...	...														
16	2063														
TCP alive check time	0-99 minutes	The time period CN2510 waits before checking if the TCP connection is alive or not. If no response is received, CN2510 will reset the port and terminate the connection.	Optional												

5. Press **Esc** to return to the **PORT MENU**.

Configuring LPD PRN Mode

1. Move the cursor to the **Mode** column for the port and then press **Enter**.

```

CN2510-8          CN2510-8_5631  V2.0
-----
[Mode] Line mOdem Welcome_MSG Quit
Examine/modify the operation mode of async ports

ESC: back to menu  Enter:  select

Port Application      Mode      Description/more setting
01 [NT Real COM      ] [ASPP   ] [Async Server Proprietary Protocol]
02 [NT Real COM      ] [ASPP   ] [Async Server Proprietary Protocol]
03 [NT Real COM      ] [ASPP   ] [Async Server Proprietary Protocol]
04 [NT Real COM      ] [ASPP   ] [Async Server Proprietary Protocol]
05 [NT Real COM      ] [ASPP   ] [Async Server Proprietary Protocol]
06 [Printer           ] [RAW PRN] [Raw serial port printer mode ]
07 [NT Real COM      ] [ASPP   ] [Async Server Proprietary Protocol]
    
```

2. Select **LPD PRN**, and then press **Enter**.

```

CN2510-8          CN2510-8_5631  V2.0
-----
[Mode] Line mOdem Welcome_MSG Quit
Examine/modify the operation mode of async ports

ESC: back to menu  Enter:  select

Port Application      Mode      Description/more setting
01 [NT Real COM      ] [ASPP   ] [Async Server Proprietary Protocol]
02 [NT Real COM      ] [ASPP   ] [Async Server Proprietary Protocol]
03 [NT Real COM      ] [ASPP   ] [Async Server Proprietary Protocol]
04 [NT Real COM      ] [ASPP   ] +-----+rver Proprietary Protocol]
05 [NT Real COM      ] [ASPP   ] | RAW PRN |rver Proprietary Protocol]
06 [Printer           ] [RAW PRN] | LPD PRN |al port printer mode ]
07 [NT Real COM      ] [ASPP   ] +-----+rver Proprietary Protocol]
08 [NT Real COM      ] [ASPP   ] [Async Server Proprietary Protocol]
    
```

3. Move the cursor to the **Description/more setting** column, and then press **Enter**.

```

CN2510-8          CN2510-8_5631  V2.0
-----
[Mode] Line mOdem Welcome_MSG Quit
Examine/modify the operation mode of async ports

ESC: back to menu  Enter:  select

Port Application      Mode      Description/more setting
01 [NT Real COM      ] [ASPP   ] [Async Server Proprietary Protocol]
02 [NT Real COM      ] [ASPP   ] [Async Server Proprietary Protocol]
03 [NT Real COM      ] [ASPP   ] [Async Server Proprietary Protocol]
04 [NT Real COM      ] [ASPP   ] [Async Server Proprietary Protocol]
05 [NT Real COM      ] [ASPP   ] [Async Server Proprietary Protocol]
06 [Printer           ] [LPD PRN] | LPD serial port printer mode |
07 [NT Real COM      ] [ASPP   ] [Async Server Proprietary Protocol]
    
```

4. The pop-up selector contains input/display fields for **Queue name <RAW>**, **Queue name <ASCII>**, **Append Form Feed**, and **TCP alive check time**. Each item is described in detail below the figure.

```

+-----+
| Queue name <RAW>   : [          ] |
| Queue name <ASCII> : [          ] |
| Append Form Feed   : [Disable]|
| TCP alive check time: [0 ] minu |
+-----+
    
```

Setting	Value	Notes	Necessity
Queue name (RAW)	Text	Specify print queue's name (in RAW mode)	Fixed
Queue name (ASCII)	Text	Specify print queue's name (in ASCII mode)	Fixed
Append Form Feed	Enable/Disable	Specify paging	Optional
TCP alive check time	0-99 minutes	The time period CN2510 waits before checking if the TCP connection is alive or not. If no response is received, CN2510 will reset the port and terminate the connection.	Optional

Configuring the Serial Ports

Open **Port Menu** → **Line** to configure serial port settings.

- From the **MAIN MENU**, select **Port**, and then press **Enter**.

```

CN2510-8                CN2510-8_5631  V2.0                MAIN MENU
-----
Server [Port] seTting sAve Utility Restart Exit
Examine/modify async server ports configuration

Enter: select  ESC: previous menu
    
```

- From the **PORT MENU**, select **Line**, and then press **Enter**.

```

CN2510-8                CN2510-8_5631  V2.0                PORT MENU
-----
Mode [Line] mOdem Welcome_MSG Quit
Examine/modify asynchronous port configuration

Enter: select  ESC: previous menu
    
```

- The **Line** page has pop-up selection lists for **Port**, **Speed**, **Bits**, **Stop**, **Parity**, **FIFO**, **RTS/CTS**, **XON/XOFF**, and **Discon. ctrl** for each serial port. Each item is described in detail below the figure.

```

CN2510-8                CN2510-8_5631  V2.0
-----
Mode [Line] mOdem Welcome_MSG Quit
Examine/modify asynchronous port configuration

ESC: back to menu  Enter: select

Port  Speed  Bits  Stop  Parity  FIFO  RTS/CTS  XON/XOFF  Discon. ctrl
01  [115200] [8]  [ 1 ] [None ] [yes]  [yes]  [no ]  [None ]
02  [115200] [8]  [ 1 ] [None ] [yes]  [yes]  [no ]  [None ]
03  [115200] [8]  [ 1 ] [None ] [yes]  [yes]  [no ]  [None ]
04  [115200] [8]  [ 1 ] [None ] [yes]  [yes]  [no ]  [None ]
05  [115200] [8]  [ 1 ] [None ] [yes]  [yes]  [no ]  [None ]
06  [115200] [8]  [ 1 ] [None ] [yes]  [yes]  [no ]  [None ]
07  [115200] [8]  [ 1 ] [None ] [yes]  [yes]  [no ]  [None ]
08  [115200] [8]  [ 1 ] [None ] [yes]  [yes]  [no ]  [None ]
    
```

Setting	Value	Notes
Speed	50 bps to 921.6 Kbps	Transmission rate
Bits	5, 6, 7, 8	Data bits
Stop	1, 1.5, 2	Stop bits
Parity	None, Even, Odd, Mark, Space	Odd, Even, Mark, Space
FIFO	Yes, No	First In First Out Device
RTS/CTS	Yes, No	Hardware Flow Control
XON/XOFF	Yes, No	Software Flow Control
Discon. Ctrl	None	DSR off or DCD off will not be interpreted as a disconnection.
	DSR off	DSR off will be interpreted as a disconnection.
	DCD off	DCD off will be interpreted as a disconnection.

4. Press **ESC** to return to the **PORT MENU**.

Save

When exiting the **SERVER MENU**, you will be prompted to save settings. Press **Y** to save.

```

CN2510-8          CN2510-8_5631  V2.0          SERVER MENU
-----
Info. Lan Adv. Host_table Route_table [User_table] Quit
Examine/modify async server basic configuration

Enter: select   ESC: previous menu

+-----+
|                                     |
|           Warning !!!              |
| You had modified the configuration  |
| without saving.                    |
| Would you save it now ?            |
|           'Y': yes      'N': no    |
|                                     |
+-----+
    
```

You may also save all settings from the **MAIN MENU** by selecting **sAve** and then pressing **Enter**. Press **Enter** again to save, and any other key to cancel.

```

CN2510-8          CN2510-8_5631  V2.0          MAIN MENU
-----
Server Port seTting [sAve] Utility Restart Exit
Save current configuration to Flash ROM

ESC: back to menu   Enter: select

+-----+
| Enter to updated, other key to cancel |
+-----+
    
```

Restart

1. From the **MAIN MENU**, select **Restart**.

```

CN2510-8          CN2510-8_5631  V2.0          MAIN MENU
-----
Server Port seTting sAve Utility [Restart] Exit
Restart the whole system or selected async ports
Enter: select  ESC: previous menu

```

2. Select **System** and then press **Enter** to restart the system and terminate the Telnet session.

```

CN2510-8          CN2510-8_5631  V2.0
-----
[System] Port  Quit
Restart the Async Server
ESC: back to menu  Enter: select

+-----+
|                               Warning !!!                               |
| Restart system will disconnect all ports and clear all status value   |
|                               Enter: continue   ESC: cancel             |
+-----+

```

Setting up Unix Hosts

UNIX uses the RLP program for remote parallel printing. For serial printing, Moxa provides the `asprint` utility program, which consists of two files, `asprint.c` and `asprint.mak`. First uncompress `printer.tar.Z` to the `\printer` directory, and then locate the files `asprint.c` and `asprint.mak`. To compile and link, you may need to modify the source file `asprint.c`. For instance, in SCO UNIX you must link to the `libnls.a` library, in Solaris to `libnsl.a`, and in Venix to the `libnsl_s.a`.

Setting up a SCO Unix Host

Steps	SCO UNIX Command	Description
Uncompress all programs	<code>#uncompress print.tar.Z</code>	
Uncompress <code>printer.tar.Z</code> to <code>./printer</code>	<code>#tar xvf printer.tar</code>	
compile/link	<code>#make -f sco_unix.mak</code>	
make printer node	<code>#mknod /dev/iop1 p</code>	Create a unique pipe name for each printer group. Since there are 16 groups of TCP port numbers (from 2048 to 2063), you need to create 16 respective pipe names. For example: <code>iop1</code> , <code>iop2</code> , <code>iop3</code> , etc.
set it to printer	<code>#chown lp /dev/iop1</code>	Change the pipe owner to <code>lp</code>

Steps	SCO UNIX Command	Description
set rw	#chmod 600 /dev/iop1	Change access permission to 600 or rw-----
set printer name	#/usr/lib/lpadmin -pLaser1 -v/dev/iop1	Redirect the printer spooler to write to pipe 'iop1'. Assumes the printer name is Laser1.
execute asprint for Group 01	#!/asprint /dev/iop1 'CN2510 IP address' 2048 &	Start 'asprint' utility to read from pipe 'iop1' and write to the CN2510 printer port. '/dev/iop1': the device name the spooler is writing to. 'CN2510': the host name of the CN2510 as defined in /etc/hosts, or its IP address. '2048': the TCP port number (Group01) of the printer port on the CN2510.
accept printer Laser1	#/usr/lib/accept Laser1	Set Laser 1 to accept print request.
enable Laser1	#enable Laser1	enable Laser1
print file to Laser1	#lp -dLaser1 file_name	send print job to the CN2510
Repeat		Repeat the above steps to set up another printer. For printers in the same group, it is not necessary to repeat every step.

Setting up a SOLARIS X86 Host

Steps	SCO UNIX Command	Description
Set free the occupied Floppy disk	#/etc/init.d/volmgt stop	
Uncompress all programs	#tar /dev/fd0 ./	
Uncompress printer.tar.Z to ./printer	#tar xvf printer.tar.Z	
compile/link	#make -f sco_unix.mak	
make printer node	#mknod /dev/iop1 p	Create a unique pipe name for each printer group. Since there are 16 groups of TCP port numbers (from 2048 to 2063), you need to create 16 respective pipe names. For example: iop1, iop2, iop3, etc.
set it to printer	#chown lp /dev/iop1	Change the pipe owner to lp
set rw	#chmod 600 /dev/iop1	Change access permission to 600 or rw-----
set printer name	#/usr/lib/lpadmin -pLaser1 -v/dev/iop1	Redirect the printer spooler to write to pipe 'iop1'. Assumes the printer name is Laser1.

Steps	SCO UNIX Command	Description
execute asprint for Group 01	<code>#!/asprint /dev/iop1 'CN2510 IP address' 2048 &</code>	Start 'asprint' utility to read from pipe 'iop1' and write to the CN2510 printer port. '/dev/iop1': the device name the spooler is writing to. 'CN2510': the host name of the CN2510 as defined in /etc/hosts, or its IP address. '2048': the TCP port number (Group01) of the printer port on the CN2510.
accept printer Laser1	<code>#!/usr/lib/accept Laser1</code>	Set Laser 1 to accept print request.
enable Laser1	<code>#!/enable printer Laser1</code>	enable Laser1
print file to Laser1	<code>#!/lp -dLaser1 file_name</code>	send print job to the CN2510
Repeat		Repeat the above steps to set up another printer. For printers in the same group, it is not necessary to repeat every step.

Setting up a LINUX Host

Steps	SCO UNIX Command	Description
Uncompress all programs	<code>#!/tar /dev/fd0 ./</code>	
Uncompress printer.tar.Z to ./printer	<code>#!/tar xvf printer.tar.Z</code>	
compile/link	<code>#!/make -f sco_unix.mak</code>	
make printer node	<code>#!/mknod /dev/iop1 p</code>	Create a unique pipe name for each printer group. Since there are 16 groups of TCP port numbers (from 2048 to 2063), you need to create 16 respective pipe names. For example: iop1, iop2, iop3, etc.
set it to printer	<code>#!/chown lp /dev/iop1</code>	Change the pipe owner to lp
set rw	<code>#!/chmod 600 /dev/iop1</code>	Change access permission to 600 or rw----
set printer name	<code>#!/usr/lib/lpadmin -pLaser1 -v/dev/iop1</code>	Redirect the printer spooler to write to pipe 'iop1'. Assumes the printer name is Laser1.
	add one line to /etc/printcap file Laser1:lp=/dev/iop1,sd=/usr/spool/Laser1	
make spool directory	<code>#!/mkdir /usr/spool/Laser1</code>	1.

Steps	SCO UNIX Command	Description
execute asprint for Group 01	<code>#!/asprint /dev/iop1 'CN2510 IP address' 2048 &</code>	Start 'asprint' utility to read from pipe 'iop1' and write to the CN2510 printer port. '/dev/iop1': the device name the spooler is writing to. 'CN2510': the host name of the CN2510 as defined in /etc/hosts, or its IP address. '2048': the TCP port number (Group01) of the printer port on the CN2510.
accept printer Laser1	<code>#lpr -PLaser1 file_name.txt</code>	Set Laser 1 to accept print request.
Repeat		Repeat the above steps to set up another printer. For printers in the same group, it is not necessary to repeat every step.

Setting up Windows Hosts

Windows uses the LPD/LPR application to access printers. Moxa provides LPD PRN mode for serial printing. In this section, we explain how to install a LPD/LPR printer in a Windows NT/2000 environment to access a serial printer connected to a CN2510 Async Server.

Setting up a Windows NT Host

1. First, you need to add TCP/IP printing service to your Windows NT.
2. Go to **Start** → **Settings** → **Control Panel** → **Network**. Click on the **Services** tab, and then select **Add**.

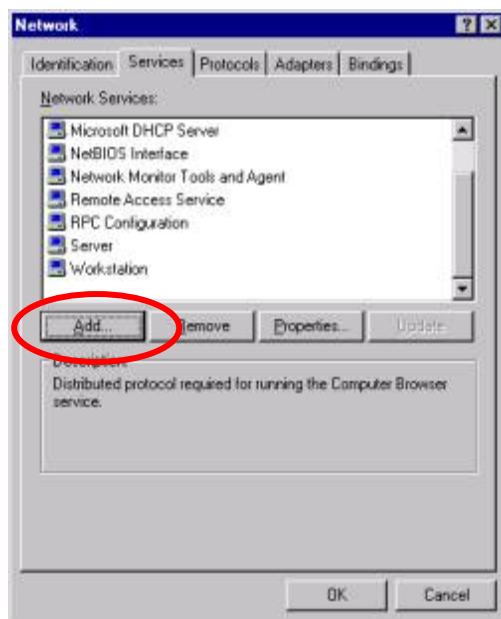

3. Select **Microsoft TCP/IP Printing**, and then click on **OK** to continue.

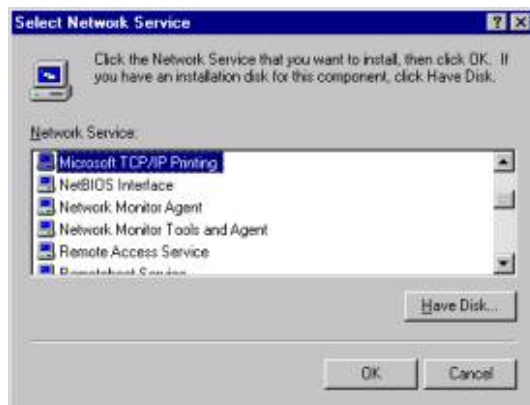

4. Insert the Windows NT installation CD to your computer's CD driver.
5. After the Microsoft TCP/IP Printing service is added, reboot your computer.

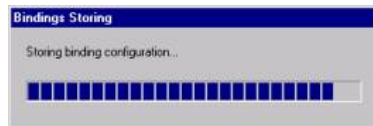

6. At this point, you can start configuring your LPR/LPD Printer.
7. Click on **Start → Settings → Printers**.



8. Click on **Add Printer** to start the **Add Printer Wizard**.



9. Select **My Computer**, and then click on **Next** to continue.

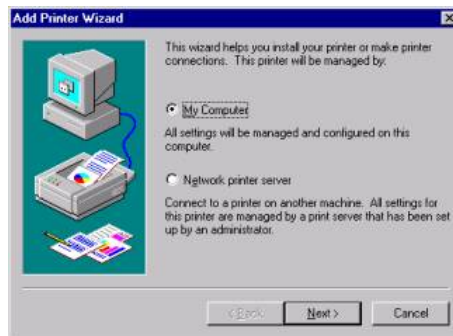

10. In the window that opens next, click on **Add Port**.

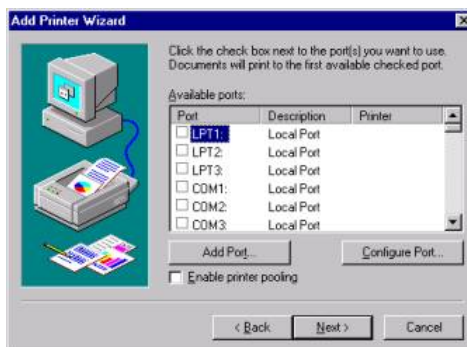

11. Select **LPR Port**. Click on **New Port...**

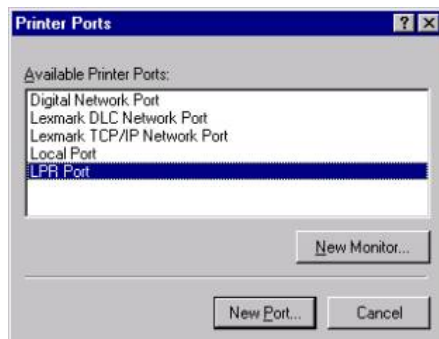

12. Enter CN2510's IP Address, and then enter the Print Queue's name. Click on **OK** to continue.

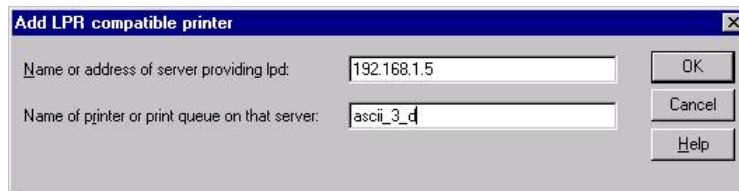

13. Select **logical printer port** for the LPR port you just added. The LPR port should be the IP address of the port.



14. Select the printer's manufacturer and model name. Click on **Next** to continue.

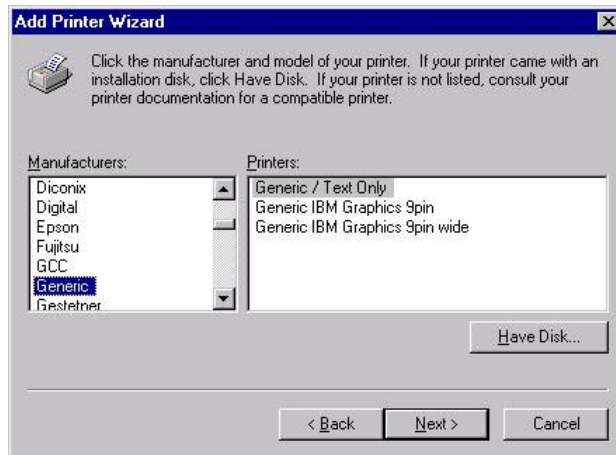

15. Enter the printer's name, and select **yes** if you wish to set this printer as the default printer. Click on **Next** to continue.



16. Select **Shared** when prompted with questions asking if the printer is to be shared or not, and then enter the name of the shared printer.

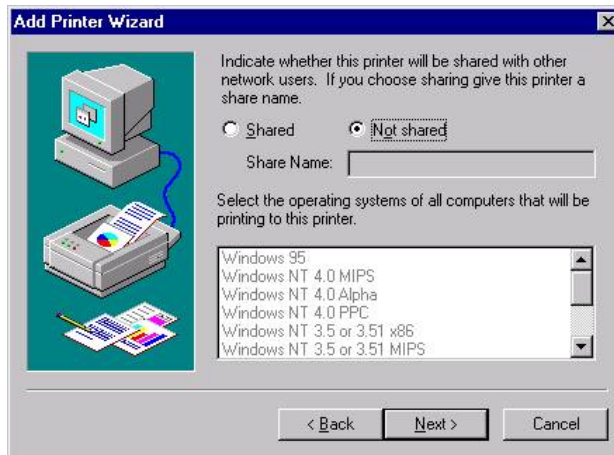

17. Print a test page to verify that the printer is configured correctly, and then click on **OK** to finish.

Setting up a Windows 2000 Host

1. Click on **Start** → **Settings** → **Printers**.

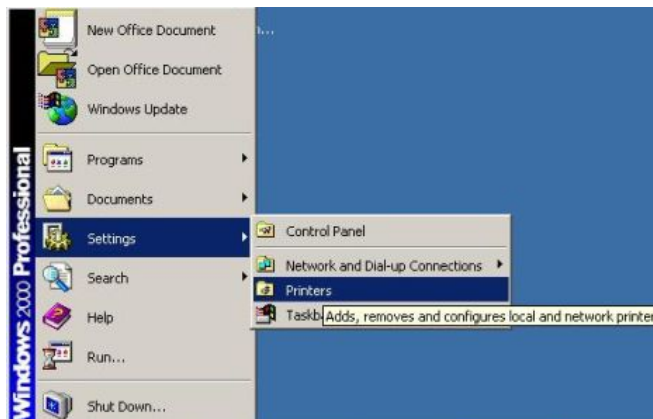

2. Click on **Add Printer** to start and **Add Printer Wizard**.
3. A Welcome message will appear. Click on **Next** to continue.



4. Select **Local printer**, and click on **Next** to continue.

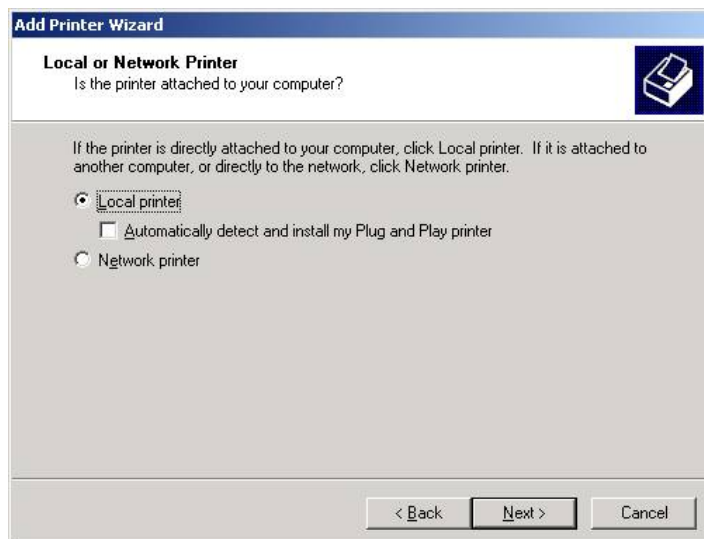

5. Select **Create a new port:**, and then select **LPR Port** from the drop down list. Click on **Next** to continue.

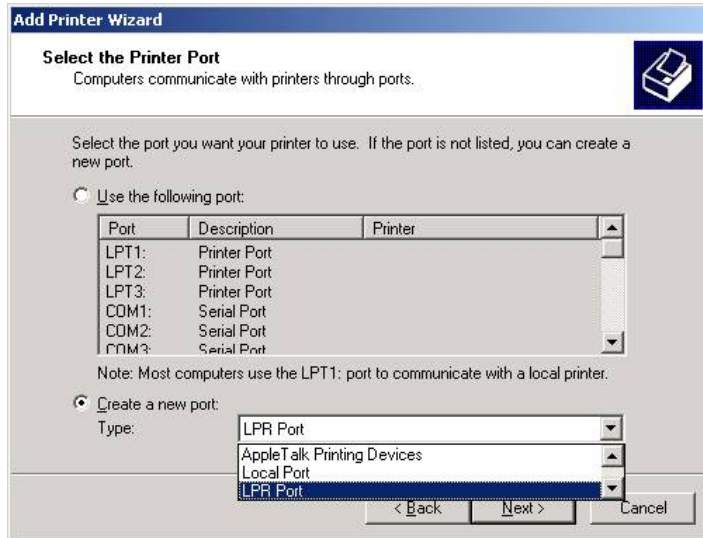

6. Enter CN2510's IP Address, and then enter the Print Queue's name. Click on **OK** to continue.

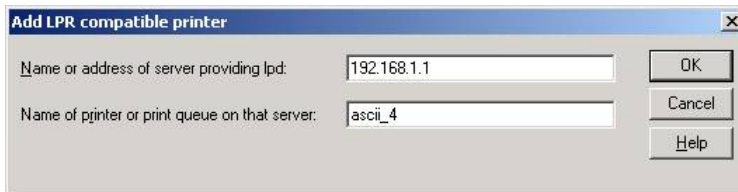

7. Select the printer's manufacturer and model name. Click on **Next** to continue.

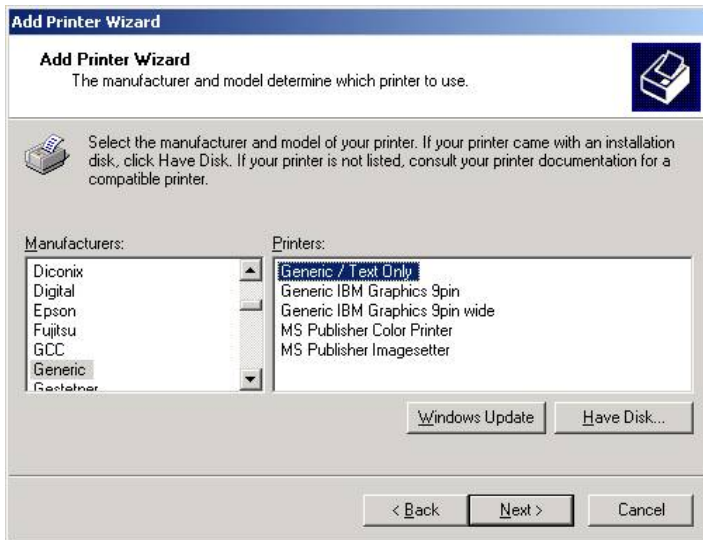

8. Enter the printer's name, and select yes if you wish to set this printer as the default printer. Click on **Next** to continue.

The screenshot shows the 'Add Printer Wizard' dialog box with the title 'Name Your Printer'. Below the title, it says 'You must assign a name for this printer.' There is a printer icon in the top right corner. The main text reads: 'Supply a name for this printer. Some programs do not support server and printer name combinations of more than 31 characters.' Below this is a text box labeled 'Printer name:' containing the text 'Your Name here'. Underneath is the question 'Do you want your Windows-based programs to use this printer as the default printer?' with two radio buttons: 'Yes' (unselected) and 'No' (selected). At the bottom, there are three buttons: '< Back', 'Next >', and 'Cancel'.

9. Select **Shared** when prompted with questions asking if the printer is to be shared or not, and then enter the name of the shared printer. Click on **Next** to continue.

The screenshot shows the 'Add Printer Wizard' dialog box with the title 'Printer Sharing'. Below the title, it says 'You can share this printer with other network users.' There is a printer icon in the top right corner. The main text reads: 'Indicate whether you want this printer to be available to other users. If you share this printer, you must provide a share name.' Below this are two radio buttons: 'Do not share this printer' (unselected) and 'Share as:' (selected). The 'Share as:' radio button is followed by a text box containing the text 'YourName'. At the bottom, there are three buttons: '< Back', 'Next >', and 'Cancel'.

10. You will need to reboot Windows 2000 to enable the printer you just added. When asked if you want to print a test page, select **No**. Click on **Next** to continue.

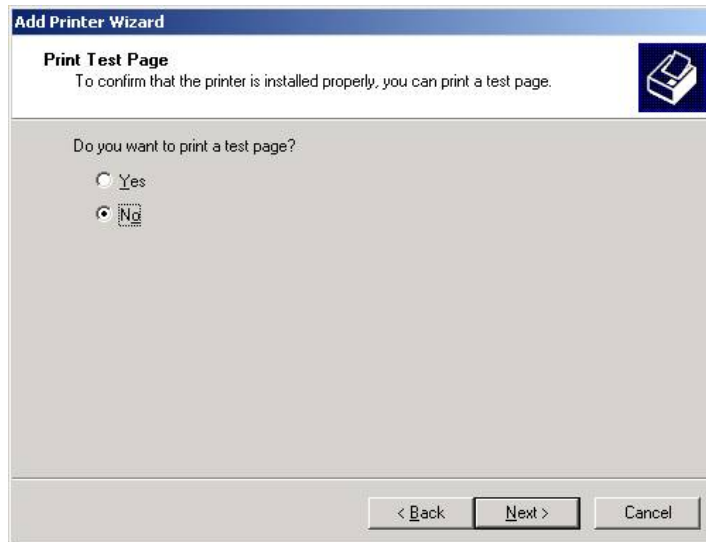

11. If you want to print a test page, reboot Windows 2000, select this printer, and click on **Print Test Page**.

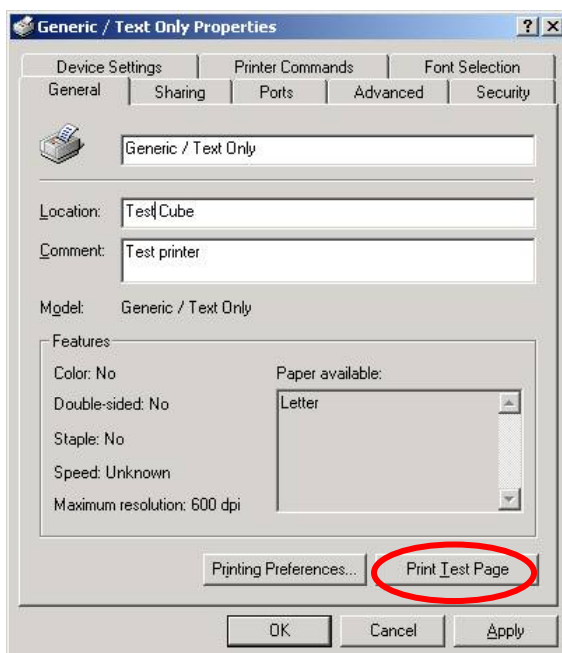

12

Setting Up Multiplex

In this chapter, we describe how to configure Moxa CN2510 as a Multiplexor and De-Multiplexor. Using the Multiplexor/De-Multiplexor application requires two Async Servers—one attached to a host with a multi-port serial board and several serial lines, and the other connected to external devices. In this way, the original host can use a TCP/IP connection to control serial devices from a remote location.

The following topics are covered in this chapter:

- Accessing the Console Utility**
- Selecting the Application**
- Configuring the “Host” CN2510**
- Configuring the “Device” CN2510**
- Configuring the Serial Ports**
- Save**
- Restart**

Accessing the Console Utility

NOTE In this section, we show how to access CN2510's console utility by Telnet over the network. For information on using the console port, see the section "Accessing the Console Utility" in Chapter 2.

1. Telnet over the network to the server's IP address.

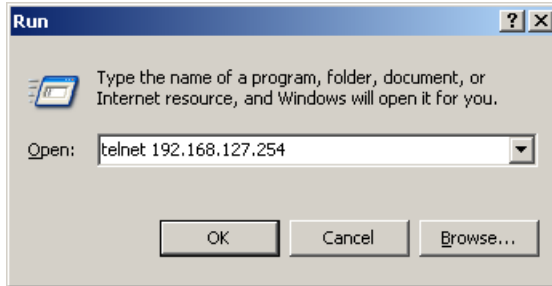

2. Type **1** to choose **ansi/vt100**, and then press **Enter**.

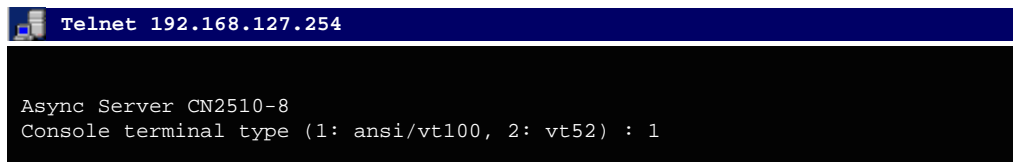

3. CN2510's **MAIN MENU** will open, as shown below.

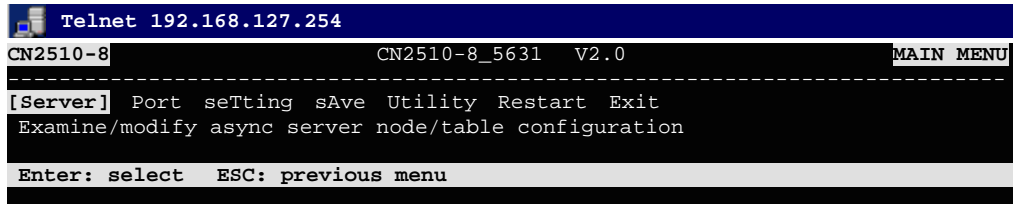

Use the following keystrokes to navigate CN2510's console utility.

Action	Key
Move	[Up/Down/Left/Right] Arrow Key or [Tab] Key
Jump to next menu, or Select item	[Enter] Key
Return to previous menu, or Close pop up selector	[Esc] Key
Shortcut Key	Capitalized letter of the word

Selecting the Application

The Multiplex application uses two Async Servers. One of the servers (called the “host” CN2510) is attached to a host with a multi-port serial board and mutiple serial lines. The other server (called the “device” CN2510) is connected to external serial devices. In this way, one host can use a TCP/IP connection to control multiple serial devices from a remote location. We use ports 5, 6, 7, and 8 on both CN2510's to illustrate.

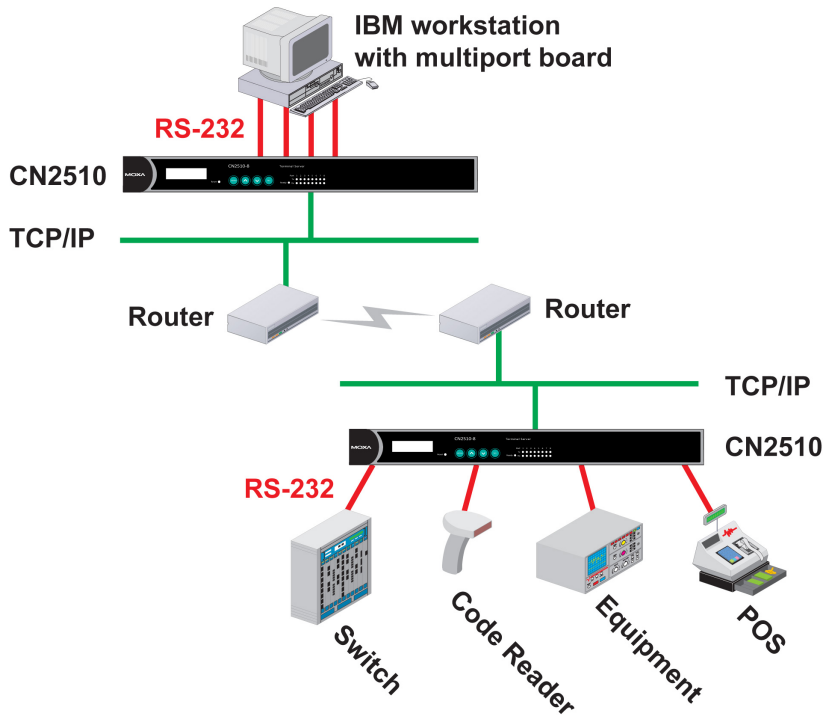

NOTE Configure the “Host” CN2510’s serial ports for RTELNET mode, and configure the “Device” CN2510’s serial ports for TERM_BIN mode.

Configuring the “Host” CN2510

Open Port Menu → Mode to select the Multiplex application.

1. From the MAIN MENU, select **Port**, and then press **Enter**.

```

CN2510-8                               CN2510-8_5631  V2.0                               MAIN MENU
-----
Server [Port] seTting sAve Utility Restart Exit
Examine/modify async server ports configuration
Enter: select  ESC: previous menu
    
```

- From the **PORT MENU**, select **Mode**, and then press **Enter**.

```

CN2510-8          CN2510-8_5631  V2.0          PORT MENU
-----
[Mode] Line mOdem Welcome_MSG Quit
Examine/modify the operation mode of async ports

Enter: select  ESC: previous menu
    
```

- The **Mode** page has pop-up selection lists for **Application**, **Mode**, and **Description/more setting** for each serial port. Use the arrow keys to move the cursor to the **Application** column for the port to be configured, and then press **Enter**. We first use Port 6 to illustrate.

```

CN2510-8          CN2510-8_5631  V2.0
-----
[Mode] Line mOdem Welcome_MSG Quit
Examine/modify the operation mode of async ports

ESC: back to menu  Enter: select

Port  Application          Mode          Description/more setting
01  [NT Real COM ] [ASPP ] [Async Server Proprietary Protocol]
02  [NT Real COM ] [ASPP ] [Async Server Proprietary Protocol]
03  [NT Real COM ] [ASPP ] [Async Server Proprietary Protocol]
04  [NT Real COM ] [ASPP ] [Async Server Proprietary Protocol]
05  [NT Real COM ] [ASPP ] [Async Server Proprietary Protocol]
06  [NT Real COM ] [ASPP ] [Async Server Proprietary Protocol]
07  [NT Real COM ] [ASPP ] [Async Server Proprietary Protocol]
08  [NT Real COM ] [ASPP ] [Async Server Proprietary Protocol]
    
```

- Use the up/down arrow keys to select **Multiplex**, and then press **Enter**.

```

CN2510-8          CN2510-8_5631  V2.0
-----
[Mode] Line mOdem Welcome_MSG Quit
Examine/modify the operation mode of async ports

ESC: back to menu  Enter: select

Port  Application          +-----+ption/more setting
01  [NT Real COM ] | Disable | Server Proprietary Protocol]
02  [NT Real COM ] | Dialin/out | Server Proprietary Protocol]
03  [NT Real COM ] | Terminal | Server Proprietary Protocol]
04  [NT Real COM ] | Reverse Terminal | Server Proprietary Protocol]
05  [NT Real COM ] | Device Control | Server Proprietary Protocol]
06  [NT Real COM ] | Multiplex | Server Proprietary Protocol]
07  [NT Real COM ] | Printer | Server Proprietary Protocol]
08  [NT Real COM ] | Multi-Host TTY | Server Proprietary Protocol]
    | NT Real COM |
    | Raw UDP |
    ]+-----+
    
```

- The Multiplex application supports two operation modes: **RTELNET** and **TERM_BIN**. RTELNET mode is selected by default. For the "Host" CN2510, use **RTELNET** mode.

```

CN2510-8          CN2510-8_5631  V2.0
-----
[Mode] Line mOdem Welcome_MSG Quit
Examine/modify the operation mode of async ports

ESC: back to menu  Enter:  select

Port  Application      Mode      Description/more setting
01   [NT Real COM      ] [ASPP   ] [Async Server Proprietary Protocol]
02   [NT Real COM      ] [ASPP   ] [Async Server Proprietary Protocol]
03   [NT Real COM      ] [ASPP   ] [Async Server Proprietary Protocol]
04   [NT Real COM      ] [ASPP   ] [Async Server Proprietary Protocol]
05   [NT Real COM      ] [ASPP   ] [Async Server Proprietary Protocol]
06   [Multiplex        ] [RTELNET] [Reverse Telnet mode                ]
07   [NT Real COM      ] [ASPP   ] [Async Server Proprietary Protocol]
08   [NT Real COM      ] [ASPP   ] [Async Server Proprietary Protocol]
    
```

NOTE Reverse Telnet, or RTELNET, supports the Telnet program used by Ethernet hosts to login to serial hosts. Ethernet hosts recognize serial ports by the specified source IP address, or by the TCP port number followed by CN2510's IP address.

- Move the cursor to the **Description/more setting** column, and then press **Enter**.

```

CN2510-8          CN2510-8_5631  V2.0
-----
[Mode] Line mOdem Welcome_MSG Quit
Examine/modify the operation mode of async ports

ESC: back to menu  Enter:  select

Port  Application      Mode      Description/more setting
01   [NT Real COM      ] [ASPP   ] [Async Server Proprietary Protocol]
02   [NT Real COM      ] [ASPP   ] [Async Server Proprietary Protocol]
03   [NT Real COM      ] [ASPP   ] [Async Server Proprietary Protocol]
04   [NT Real COM      ] [ASPP   ] [Async Server Proprietary Protocol]
05   [NT Real COM      ] [ASPP   ] [Async Server Proprietary Protocol]
06   [Multiplex        ] [RTELNET] [Reverse Telnet mode                ]
07   [NT Real COM      ] [ASPP   ] [Async Server Proprietary Protocol]
08   [NT Real COM      ] [ASPP   ] [Async Server Proprietary Protocol]
    
```

- The pop-up selector contains input/display fields for **TCP port**, **Source IP address**, **Destination IP addr**, **Inactivity time**, **Map keys <CR-LF> to**, **Authentication type**, and **TCP alive check time**. Each item is described in detail below the figure.

```

+-----+
| TCP port      : [4006 ] |
| Source IP address : [          ] |
| Destination IP addr : [          ] |
| Inactivity time : [0 ] minutes |
| Map keys <CR-LF> to : [CR-LF] |
| Authentication type : [none ] |
| TCP alive check time : [0 ] minutes |
+-----+
    
```

Setting	Value	Notes	Necessity
TCP port	number	Each of CN2510's serial ports is mapped to a TCP port. To avoid conflicts with the TCP port numbers for CN2510's other serial ports, use the default values: 4001 for port 1, 4002 for port 2, etc.	Required
Source IP address	IP address for the port	Specify an IP address for this port for application purposes. If left blank, CN2510 will use its own IP address, in which case you will need to specify different TCP port numbers for different serial ports.	Optional
Destination IP addr	IP address	Assign a host IP address on the LAN for exclusive port access. If left blank, all hosts on the network will have access to this port.	Optional
Map Keys <CR-LF> to	CR/LF/CR-LF	When you enter the string <CR-LF>, CN2510 will determine whether to send <CR>, <LF>, or <CR-LF>.	Optional
Inactivity time	0-99 minutes	Idle time before the port is disconnected automatically. If set to 0 minutes, the port will not disconnect.	Optional
Authentication type	None/local /server	None: Authentication is not required. local: Check the ID stored in the User_table (defined under the SERVER MENU). Server: Check the ID with the external RADIUS server. Refer to Appendix C for RADIUS installation information.	Optional
TCP alive check time	0-99 minutes	The time period CN2510 waits before checking if the TCP connection is alive or not. If no response is received, CN2510 will reset the port and terminate the connection.	Optional

8. Repeat the previous steps for ports 5, 7, and 8.

```

CN2510-8                               CN2510-8_5631  V2.0
-----
[Mode] Line mOdem Welcome MSG Quit
Examine/modify the operation mode of async ports

ESC: back to menu  Enter: select

Port  Application      Mode      Description/more setting
01  [NT Real COM      ] [ASPP   ] [Async Server Proprietary Protocol]
02  [NT Real COM      ] [ASPP   ] [Async Server Proprietary Protocol]
03  [NT Real COM      ] [ASPP   ] [Async Server Proprietary Protocol]
04  [NT Real COM      ] [ASPP   ] [Async Server Proprietary Protocol]
05  [Multiplex        ] [RTELNET] [Reverse Telnet mode                ]
06  [Multiplex        ] [RTELNET] [Reverse Telnet mode                ]
07  [Multiplex        ] [RTELNET] [Reverse Telnet mode                ]
08  [Multiplex        ] [RTELNET] [Reverse Telnet mode                ]

```

Configuring the "Device" CN2510

1. From the **MAIN MENU**, select **Port**, and then press **Enter**.

```

CN2510-8          CN2510-8_5631  V2.0          MAIN MENU
-----
Server [Port] seTting sAve Utility Restart Exit
Examine/modify async server ports configuration

Enter: select  ESC: previous menu
    
```

2. From the **PORT MENU**, select **Mode**, and then press **Enter**.

```

CN2510-8          CN2510-8_5631  V2.0          PORT MENU
-----
[Mode] Line mOdem Welcome_MSG Quit
Examine/modify the operation mode of async ports

Enter: select  ESC: previous menu
    
```

3. The **Mode** page has pop-up selection lists for **Application**, **Mode**, and **Description/more setting** for each serial port. Use the arrow keys to move the cursor to the **Application** column for the port to be configured, and then press **Enter**. We first use Port 6 to illustrate.

```

CN2510-8          CN2510-8_5631  V2.0
-----
[Mode] Line mOdem Welcome_MSG Quit
Examine/modify the operation mode of async ports

ESC: back to menu  Enter: select

Port  Application          Mode          Description/more setting
01   [NT Real COM ] [ASPP ] [Async Server Proprietary Protocol]
02   [NT Real COM ] [ASPP ] [Async Server Proprietary Protocol]
03   [NT Real COM ] [ASPP ] [Async Server Proprietary Protocol]
04   [NT Real COM ] [ASPP ] [Async Server Proprietary Protocol]
05   [NT Real COM ] [ASPP ] [Async Server Proprietary Protocol]
06   [NT Real COM ] [ASPP ] [Async Server Proprietary Protocol]
07   [NT Real COM ] [ASPP ] [Async Server Proprietary Protocol]
08   [NT Real COM ] [ASPP ] [Async Server Proprietary Protocol]
    
```

4. Use the up/down arrow keys to select **Multiplex**, and then press **Enter** to confirm.

```

CN2510-8          CN2510-8_5631  V2.0
-----
[Mode] Line mOdem Welcome_MSG Quit
Examine/modify the operation mode of async ports

ESC: back to menu  Enter: select

Port  Application          +-----+ption/more setting
01   [NT Real COM ] | Disable | Server Proprietary Protocol]
02   [NT Real COM ] | Dialin/out | Server Proprietary Protocol]
03   [NT Real COM ] | Terminal | Server Proprietary Protocol]
04   [NT Real COM ] | Reverse Terminal | Server Proprietary Protocol]
05   [NT Real COM ] | Device Control | Server Proprietary Protocol]
06   [NT Real COM ] | Multiplex | Server Proprietary Protocol]
07   [NT Real COM ] | Printer | Server Proprietary Protocol]
08   [NT Real COM ] | Multi-Host TTY | Server Proprietary Protocol]
      | NT Real COM |
      | Raw UDP |
      +-----+
    
```

- The Multiplex application supports two operation modes: **RTELNET** and **TERM_BIN**. RTELNET mode is selected by default. For the "Device" CN2510, select **TERM_BIN** mode.

```

CN2510-8          CN2510-8_5631  V2.0
-----
[Mode] Line mOdem Welcome_MSG Quit
Examine/modify the operation mode of async ports

ESC: back to menu  Enter:  select

Port  Application      Mode      Description/more setting
01   [NT Real COM      ] [ASPP   ] [Async Server Proprietary Protocol]
02   [NT Real COM      ] [ASPP   ] [Async Server Proprietary Protocol]
03   [NT Real COM      ] [ASPP   ] [Async Server Proprietary Protocol]
04   [NT Real COM      ] [ASPP   ] [Async Server Proprietary Protocol]
05   [NT Real COM      ] [ASPP   ] [Async Server Proprietary Protocol]
06   [Multiplex         ] [RTELNET] [Reverse Telnet mode                ]
07   [NT Real COM      ] [ASPP   ] [Async Server Proprietary Protocol]
08   [NT Real COM      ] [ASPP   ] [Async Server Proprietary Protocol]
    
```

- Move the cursor to the **Mode** column for the port and then press **Enter**.

```

CN2510-8          CN2510-8_5631  V2.0
-----
[Mode] Line mOdem Welcome_MSG Quit
Examine/modify the operation mode of async ports

ESC: back to menu  Enter:  select

Port  Application      Mode      Description/more setting
01   [NT Real COM      ] [ASPP   ] [Async Server Proprietary Protocol]
02   [NT Real COM      ] [ASPP   ] [Async Server Proprietary Protocol]
03   [NT Real COM      ] [ASPP   ] [Async Server Proprietary Protocol]
04   [NT Real COM      ] [ASPP   ] [Async Server Proprietary Protocol]
05   [NT Real COM      ] [ASPP   ] [Async Server Proprietary Protocol]
06   [Multiplex         ] [RTELNET] [Reverse Telnet mode                ]
07   [NT Real COM      ] [ASPP   ] [Async Server Proprietary Protocol]
08   [NT Real COM      ] [ASPP   ] [Async Server Proprietary Protocol]
    
```

- Use the arrow keys to highlight **TERM_BIN**, and then press **Enter**.

```

CN2510-8          CN2510-8_5631  V2.0
-----
[Mode] Line mOdem Welcome_MSG Quit
Examine/modify the operation mode of async ports

ESC: back to menu  Enter:  select

Port  Application      Mode      Description/more setting
01   [NT Real COM      ] [ASPP   ] [Async Server Proprietary Protocol]
02   [NT Real COM      ] [ASPP   ] [Async Server Proprietary Protocol]
03   [NT Real COM      ] [ASPP   ] [Async Server Proprietary Protocol]
04   [NT Real COM      ] [ASPP   ] [Async Server Proprietary Protocol]
05   [NT Real COM      ] [ASPP   ] [RTELNET |rver Proprietary Protocol]
06   [Multiplex         ] [RTELNET] [TERM_BIN |Telnet mode                ]
07   [NT Real COM      ] [ASPP   ] [Async Server Proprietary Protocol]
08   [NT Real COM      ] [ASPP   ] [Async Server Proprietary Protocol]
    
```

- The next step is to configure the TERM_BIN parameters.

```

CN2510-8          CN2510-8_5631  V2.0
-----
[Mode] Line mOdem Welcome_MSG Quit
Examine/modify the operation mode of async ports

ESC: back to menu  Enter:  select

Port Application      Mode      Description/more setting
01 [NT Real COM      ] [ASPP   ] [Async Server Proprietary Protocol]
02 [NT Real COM      ] [ASPP   ] [Async Server Proprietary Protocol]
03 [NT Real COM      ] [ASPP   ] [Async Server Proprietary Protocol]
04 [NT Real COM      ] [ASPP   ] [Async Server Proprietary Protocol]
05 [NT Real COM      ] [ASPP   ] [Async Server Proprietary Protocol]
06 [Multiplex        ] [TERM_BIN] [Binary Terminal mode (1 session) ]
07 [NT Real COM      ] [ASPP   ] [Async Server Proprietary Protocol]
08 [NT Real COM      ] [ASPP   ] [Async Server Proprietary Protocol]
    
```

NOTE Terminal Binary, or TERM_BIN mode, supports automatic link to Ethernet hosts for Terminal or Telnet users by redirecting Telnet requests to the specified Ethernet host. Below we describe how to set auto-link host and login ID information. Auto-linking one TERM_BIN port to a port in RTELNET mode provides a transparent link through the network.

- Move the cursor to the **Description/more setting** column, and then press **Enter**.

```

CN2510-8          CN2510-8_5631  V2.0
-----
[Mode] Line mOdem Welcome_MSG Quit
Examine/modify the operation mode of async ports

ESC: back to menu  Enter:  select

Port Application      Mode      Description/more setting
01 [NT Real COM      ] [ASPP   ] [Async Server Proprietary Protocol]
02 [NT Real COM      ] [ASPP   ] [Async Server Proprietary Protocol]
03 [NT Real COM      ] [ASPP   ] [Async Server Proprietary Protocol]
04 [NT Real COM      ] [ASPP   ] [Async Server Proprietary Protocol]
05 [NT Real COM      ] [ASPP   ] [Async Server Proprietary Protocol]
06 [Multiplex        ] [TERM_BIN] [Binary Terminal mode (1 session) ]
07 [NT Real COM      ] [ASPP   ] [Async Server Proprietary Protocol]
08 [NT Real COM      ] [ASPP   ] [Async Server Proprietary Protocol]
    
```

- The pop-up selector contains input/display fields for **Quit key**, **Auto-link protocol**, **Link by input IP**, **Auto-login prompt**, **Terminal type**, **Inactivity time**, **Authentication type**, and **TCP alive check time**. Each item is described in detail below the figure.

```

+-----+
Quit key           : [^E]
Auto-link protocol : [none  ]
  Telnet TCP port  : [23   ]
  Primary host IP  : [          ]
Link by input IP   : [Disable]
  Secondary host IP: [          ]
Auto-login prompt  : [ogin:  ]
  Password prompt  : [assword:]
  Login user name  : [          ]
  Login password   : [          ]
Terminal type      : [ansi   ]
Inactivity time    : [0  ] minutes
Authentication type: [local  ]
TCP alive check time: [0  ] minutes
+-----+
    
```

Setting	Value	Notes	Necessity
Quit Key	^E	Defines the Quit key used to disconnect the link between the current terminal session and the remote host. It may be left blank for binary communication.	Optional
Auto-link protocol	None/Telnet/Rlogin	None: Do not connect to the host automatically. Telnet: Connects to the host automatically by Telnet. Rlogin: Connects to the host automatically by Rlogin.	Optional
Telnet TCP port	23	By default, the Telnet TCP port number is set to 23, which is the default TCP port number for Telnet. If you need to telnet to this CN2510 serial port, set the Telnet TCP port to a different number. We recommend using 4001, 4002, etc. for ports 1, 2, etc. to avoid conflicts with other ports.	Required
Primary host IP	IP address or the name defined in the [Host] table	If specified, designates a 'permanent' host to which the terminal will always be connected.	Optional
Link by input IP	Enable/Disable	For users to enter the connection IP address manually.	Optional
Secondary host IP	IP address or the name defined in the [Host] table.	If specified, designates a secondary 'permanent' host to which the terminal will be connected.	Optional
Auto-login prompt	ogin:	Send ID information when this prompt is received.	Optional
Password prompt	assword:	Send Password information when this prompt is received	Optional
Login user name		Login ID	Optional
Login password		Login Password	Optional
Terminal type	ansi	Terminal type for outgoing connection	Optional
Inactivity time	0-99 minutes	Idle time before the port is disconnected automatically. If set to 0 minutes, the port will not disconnect.	Optional
Authentication type	None/local/server	None: Authentication is not required. local: Check the ID stored in the User_table (defined under the SERVER MENU). Server: Check the ID with the external RADIUS server. Refer to Appendix C for RADIUS installation information.	Optional

Setting	Value	Notes	Necessity
TCP alive check time	0-99 minutes	The time period CN2510 waits before checking if the TCP connection is alive or not. If no response is received, CN2510 will reset the port and terminate the connection.	Optional

- Repeat the previous steps for ports 5, 7, and 8.

```

CN2510-8                               CN2510-8_5631  V2.0
-----
[Mode] Line mOdem Welcome_MSG Quit
Examine/modify the operation mode of async ports

ESC: back to menu  Enter: select

Port Application      Mode      Description/more setting
01 [NT Real COM      ] [ASPP   ] [Async Server Proprietary Protocol]
02 [NT Real COM      ] [ASPP   ] [Async Server Proprietary Protocol]
03 [NT Real COM      ] [ASPP   ] [Async Server Proprietary Protocol]
04 [NT Real COM      ] [ASPP   ] [Async Server Proprietary Protocol]
05 [Multiplex        ] [TERM_BIN] [Binary Terminal mode (1 session) ]
06 [Multiplex        ] [TERM_BIN] [Binary Terminal mode (1 session) ]
07 [Multiplex        ] [TERM_BIN] [Binary Terminal mode (1 session) ]
08 [Multiplex        ] [TERM_BIN] [Binary Terminal mode (1 session) ]
    
```

Configuring the Serial Ports

Open **Port Menu** → **Line** to configure serial port settings.

- From the **MAIN MENU**, select **Port**, and then press **Enter**.

```

CN2510-8                               CN2510-8_5631  V2.0                               MAIN MENU
-----
Server [Port] seTting sAve Utility Restart Exit
Examine/modify async server ports configuration

Enter: select  ESC: previous menu
    
```

- From the **PORT MENU**, select **Line**, and then press **Enter**.

```

CN2510-8                               CN2510-8_5631  V2.0                               PORT MENU
-----
Mode [Line] mOdem Welcome_MSG Quit
Examine/modify asynchronous port configuration

Enter: select  ESC: previous menu
    
```

You may also save all settings from the **MAIN MENU** by selecting **sAve** and then pressing **Enter**. Press **Enter** again to save, and any other key to cancel.

```

CN2510-8          CN2510-8_5631  V2.0          MAIN MENU
-----
Server Port seTting [sAve] Utility Restart Exit
Save current configuration to Flash ROM
ESC: back to menu  Enter:  select

+-----+
|Enter to updated, other key to cancel|
+-----+
    
```

Restart

1. From the **MAIN MENU**, select **Restart**.

```

CN2510-8          CN2510-8_5631  V2.0          MAIN MENU
-----
Server Port seTting sAve Utility [Restart] Exit
Restart the whole system or selected async ports
Enter: select  ESC: previous menu
    
```

2. Select **System** and then press **Enter** to restart the system and terminate the Telnet session.

```

CN2510-8          CN2510-8_5631  V2.0
-----
[System] Port Quit
Restart the Async Server
ESC: back to menu  Enter:  select

+-----+
|Warning !!!|
|Restart system will disconnect all ports and clear all status value|
|Enter: continue  ESC: cancel|
+-----+
    
```

Setting Up Routing

Routing is the main process used by Internet hosts to deliver packets. The Internet uses a hop-by-hop routing model, which means that each host or router that handles a packet examines the Destination Address in the IP header, computes the next hop that will bring the packet one step closer to its destination, and then delivers the packet to the next hop, where the process is repeated.

Two things are needed to make this work: (1) Routing tables must match destination addresses with next hops, and (2) routing protocols must determine the contents of these tables.

CN2510 provides easy-to-use routing functions that support both static routing tables and dynamic RIP1/RIP2 routing protocols. This chapter illustrates how to configure static routing tables and dynamic RIP1/RIP2 protocols. A few routing examples are also given to illustrate some basic routing concepts.

The following topics are covered in this chapter:

- Accessing the Console Utility**
- What is RIP?**
- Configuring RIP**
- Configuring the Static Routing Table**
- Static Routing Examples**
 - Configuring Routes to the Internet
 - Configuring Routes to the Internet and Intranet
 - Configuring Multiple-Point Routes
- Save**
- Restart**

Accessing the Console Utility

NOTE In this section, we show how to access CN2510's console utility by Telnet over the network. For information on using the console port, see the section "Accessing the Console Utility" in Chapter 2.

1. Telnet over the network to the server's IP address.

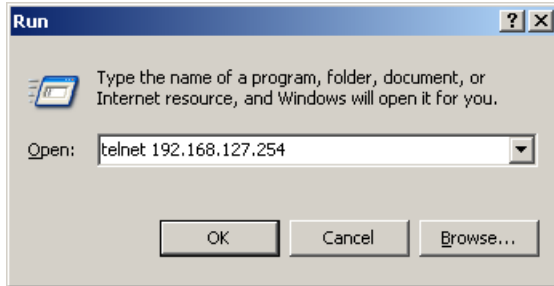

2. Type **1** to choose **ansi/vt100**, and then press **Enter**.

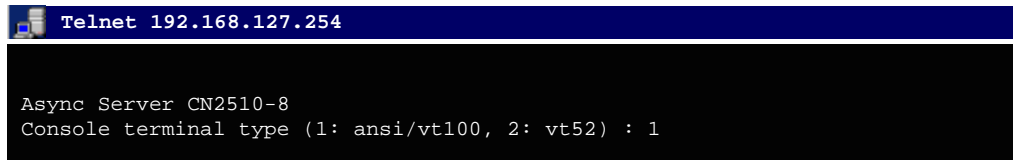

3. CN2510's **MAIN MENU** will open, as shown below.

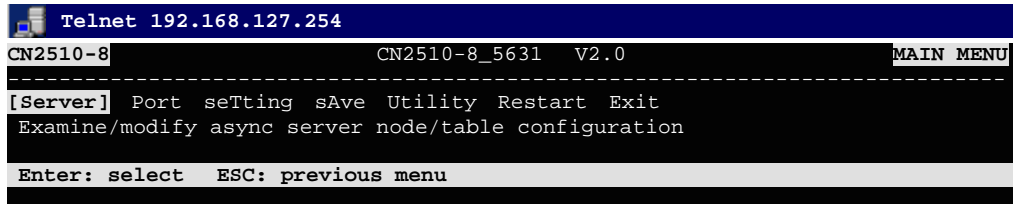

Use the following keystrokes to navigate CN2510's console utility.

Action	Key
Move	[Up/Down/Left/Right] Arrow Key or [Tab] Key
Jump to next menu, or Select item	[Enter] Key
Return to previous menu, or Close pop up selector	[Esc] Key
Shortcut Key	Capitalized letter of the word

What is RIP?

RIP (Routing Information Protocol) is a protocol used widely to manage routing information within a self-contained network, such as a corporate LAN (Local Area Network) or an interconnected group of such LANs.

By using RIP, a gateway host with a router can send its entire routing table, which lists all the other hosts it knows about, to its closest neighbor host every 30 seconds. The neighbor host in turn will pass this information on to its closest neighbor, and so on, until all hosts within the network have the same routing path information. This state is known as network convergence. RIP uses a hop count as a way of determining network distance. (Other protocols use more sophisticated algorithms that also include timing.) After receiving a packet headed for a specific destination, a network host with a router uses the routing table information to determine the next host to route the packet to.

RIP is considered an effective solution for small homogeneous networks. For larger, more complicated networks, transmitting the entire routing table every 30 seconds can bog down the network with a lot of extra traffic.

RIP 2 is an extension of RIP. Its purpose is to expand the amount of useful information contained in RIP packets, and to add security elements. RIP version 2 recently became the standard version of RIP, and the original RIP is no longer in use.

Configuring RIP

Open **Server Menu** → **Adv.** to configure **Dynamic routing**.

1. From the **MAIN MENU**, select **Server**, and then press **Enter**.

```

CN2510-8                      CN2510-8_5631  V2.0                      MAIN MENU
-----
[Server] Port seTting sAve Utility Restart Exit
Examine/modify async server node/table configuration
Enter: select  ESC: previous menu

```

2. From the **SERVER MENU**, select **Adv.**, and then press **Enter**.

```

CN2510-8                      CN2510-8_5631  V2.0                      SERVER MENU
-----
Info.  Lan [Adv.] Host_table Route_table User_table Quit
Examine/modify async server advance configuration
Enter: select  ESC: previous menu

```

- Use the Up/Down arrow keys to move the cursor to the **Routing protocol** pop-up selector. Press **Enter** to see the options. Select **RIP-1** or **RIP-2**. The RIP setting is only for sending packets. For receiving packets, CN2510 supports both RIP-1 and RIP-2.

```

CN2510-8          CN2510-8_5631  V2.0
-----
Info.  Lan  [Adv.]  Host_table  Route_table  User_table  Quit
Examine/modify async server advance configuration

ESC: back to menu  Enter:  select

RADIUS server IP      [          ]
RADIUS key            [          ]
UDP port <1:1645 2:1812> [1]
Enable RADIUS accounting [no ]

SNMP community name  [public          ]
SNMP trap server IP address [          ]

Ethernet IP forwarding [no ] | None |
Routing protocol      [None ] | RIP-1 |
                       | RIP-2 |

TCP retransmission timeout [          ]+-----+: 50 - 60000 ms)
SIO data transfer timeout [          ] (range: 0 - 1000 ms)
    
```

- Press **Esc** to return to the **MAIN MENU**.

Configuring the Static Routing Table

Although RIP-1 and RIP-2 periodically update routing tables between different routers, you still need to add routing entries in the routing table for routes only directed to you.

Open **Server Menu** → **Route_table** to configure the static routing table.

- From the **MAIN MENU**, select **Server**, and then press **Enter**.

```

CN2510-8          CN2510-8_5631  V2.0          MAIN MENU
-----
[Server]  Port seTting sAve Utility Restart Exit
Examine/modify async server node/table configuration

Enter: select  ESC: previous menu
    
```

- From the **SERVER MENU**, select **Route_table** and then press **Enter**.

```

CN2510-8          CN2510-8_5631  V2.0          SERVER MENU
-----
Info.  Lan  Adv.  Host_table  [Route_table]  User_table  Quit
Examine/modify the routing table

Enter: select  ESC: previous menu
    
```

- Use the tab and arrow keys to move the cursor to configure **Gateway**, **Destination**, **Netmask**, and **Metric**. Each item is described in detail below the figure.

```

CN2510-8          CN2510-8_5631  V2.0
-----
Info. Lan Adv. Host_table [Route_table] User_table Quit
Examine/modify the routing table
ESC: back to menu  Enter: select

Entry   Gateway   Destination   Netmask   Metric
01      [         ] [         ] [         ] [         ] [01]
02      [         ] [         ] [         ] [         ] [01]
03      [         ] [         ] [         ] [         ] [01]
04      [         ] [         ] [         ] [         ] [01]
    
```

Setting	Value	Notes	Necessity
Entry	01-32	A maximum of 32 entries are allowed.	Fixed
Gateway	xxx.xxx.xxx.xxx	The IP address of the next-hop router.	Required
Destination	xxx.xxx.xxx.xxx	The host IP address or network address of the route's destination.	Required
Netmask	xxx.xxx.xxx.xxx	The destination network's netmask.	Required
Metric	1-15	The number of hops from the source destination.	Required

- Press **Esc** to return to the **MAIN MENU**.

Static Routing Examples

Configuring Routes to the Internet

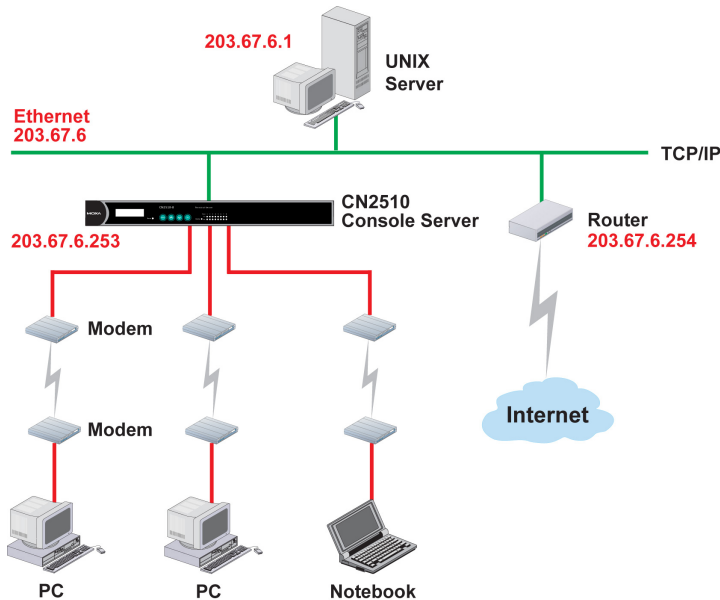

For this example, the Notebook PC dials in to the CN2510 to request a connection to Internet host 210.48.96.9 (for example), which is not on local network 203.67.6. This causes CN2510 to act as a router and send the datagram to the default next-hop router, 203.67.6.254. In this case we should add the default gateway IP address (203.67.6.254) to the routing table, as shown in the following figure, to handle hops to any destination beyond the local network (203.67.6).

```

CN2510-8                               CN2510-8_5631  V2.0
-----
Info. Lan Adv. Host_table [Route_table] User_table Quit
Examine/modify the routing table
ESC: back to menu  Enter: select
-----
Entry   Gateway           Destination         Netmask           Metric
01     [203.67.6.254 ] [0.0.0.0           ] [0.0.0.0         ] [01]
02     [                ] [                  ] [                 ] [01]
03     [                ] [                  ] [                 ] [01]
    
```

Configuring Routes to the Internet and Intranet

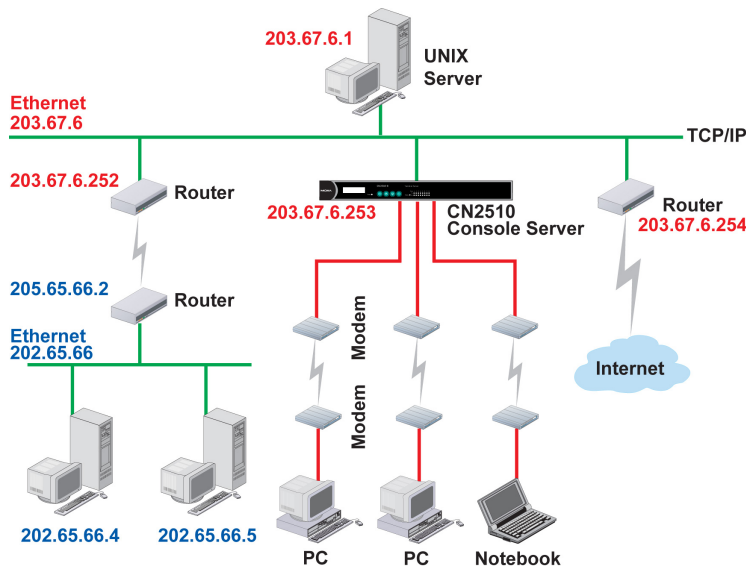

For this example, in addition to sending requests to the Internet, dial-in users can make requests to Intranet hosts 202.65.66.4 or 202.65.66.5, which are on network 202.65.66 (located outside network 203.67.6). In this case, add a route entry for the next-hop router, 203.67.6.252, that delivers requests to network 202.65.66. The metric hop in this case is 2 route hops.

```

CN2510-8                               CN2510-8_5631  V2.0
-----
Info. Lan Adv. Host_table [Route_table] User_table Quit
Examine/modify the routing table
ESC: back to menu  Enter: select
-----
Entry   Gateway           Destination         Netmask           Metric
01     [203.67.6.254 ] [0.0.0.0           ] [0.0.0.0         ] [01]
02     [203.67.6.252 ] [203.65.66.0       ] [255.255.255.0   ] [01]
03     [                ] [                  ] [                 ] [01]
    
```

Configuring Multiple-Point Routes

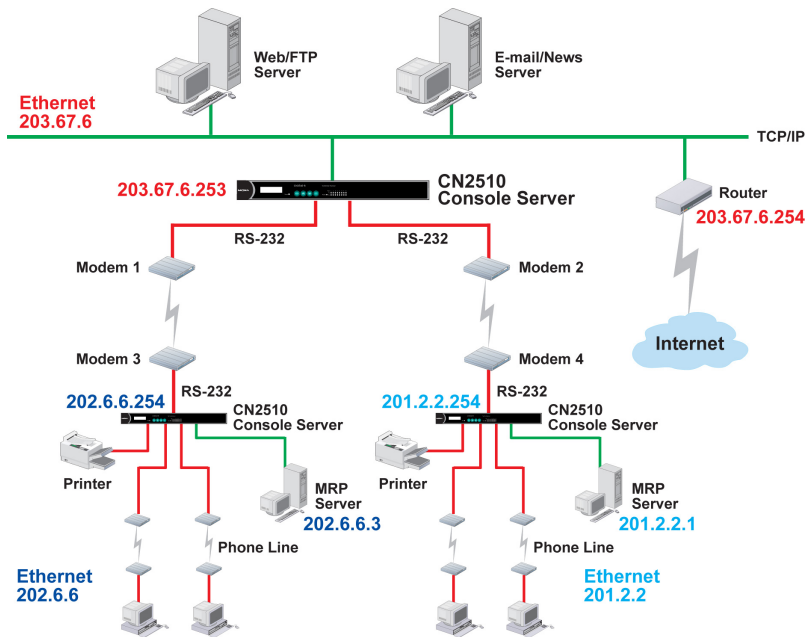

For multi-location enterprises, CN2510 can be placed in different branch offices and used as both a multi-point router and remote access server. When hosts (e.g., the Web/FTP and E-mail/News servers shown in the figure) send requests to hosts on another network, such as 202.6.6 or 201.2.2, CN2510 delivers the request to the remote end CN2510, 202.6.6.254 or 201.2.2.254, as the next-hop router. Requests to Internet hosts are still sent through router 203.67.6.254 as the next-hop router.

For this example, assume that the PPP source and destination IPs of modems 1, 2, 3, and 4 are:

	Source IP	Destination IP		Source IP	Destination IP
Modem 1	203.67.6.250	202.6.6.250	Modem 3	202.6.6.250	203.67.6.250
Modem 2	203.67.6.249	201.2.2.249	Modem 4	201.2.2.249	203.67.6.249

In this case, you will need to add three entries to the routing table, as shown below.

```

CN2510-8                               CN2510-8_5631  V2.0
-----
Info. Lan Adv. Host_table [Route_table] User_table Quit
Examine/modify the routing table

ESC: back to menu  Enter: select

Entry   Gateway           Destination       Netmask          Metric
01      [203.67.6.254 ] [0.0.0.0 ] [0.0.0.0 ] [01]
02      [203.67.6.250 ] [202.6.6.0 ] [255.255.255.0 ] [01]
03      [203.67.6.249 ] [201.2.2.0 ] [255.255.255.0 ] [01]
04      [                ] [                ] [                ] [01]
    
```

Administrative Utilities

In this chapter, we show how to use CN2510 administrative utilities, which include **Ping** (to see if a LAN host is still active), and how to get information with **Monitor → Line**, **Monitor → Network**, **Monitor → Async**, **Monitor → Routing**, and **Monitor → PPP-Trace**.

The following topics are covered in this chapter:

- ❑ **Ping**
- ❑ **Monitor**
 - Line
 - Network
 - Async
 - Routing
 - PPP-Trace
- ❑ **Diagnostic**
- ❑ **Upgrade**
 - Upgrading with the Windows Utility
 - Console Terminal Upgrade
 - Upgrading through the Serial Console
 - Remote RCP Upgrade
- ❑ **Export**
 - Console Terminal Export
 - Remote RCP Export
- ❑ **Import**
 - Console Terminal Import
 - Remote RCP Import
- ❑ **Default**

Ping

Ping is used to test network hardware connectivity and whether a network host is active.

1. From the **MAIN MENU**, select **Utility**, and then press **Enter**.

```

CN2510-8          CN2510-8_5631  V2.0          MAIN MENU
-----
Server Port seTting sAve [Utility] Restart Exit
Async server utilities
Enter: select  ESC: previous menu
    
```

2. From the **UTILITY MENU**, select **Ping**, and then press **Enter**.

```

CN2510-8          CN2510-8_5631  V2.0          UTILITY MENU
-----
[Ping] Monitor Diagnostic Upgrade Quit
Ping a host
Enter: select  ESC: previous menu
    
```

3. Enter the **target host IP address** or **target host name**, and then press **Enter**.

```

CN2510-8          CN2510-8_5631  V2.0
-----
[Ping] Monitor Diagnostic Upgrade Quit
Ping a host
ESC: back to menu  Enter: select

Press ESC to cancel ...
PING 192.168.1.3: 56 data bytes
64 bytes from 192.168.1.3: icmp_seq=0. time=0 ms
64 bytes from 192.168.1.3: icmp_seq=1. time=0 ms
64 bytes from 192.168.1.3: icmp_seq=2. time=0 ms
    
```

4. Press **Esc** to return to **Ping**.

Monitor

The **Monitor** utility allows you to monitor serial line status (**Line**), network status (**Network**), serial transmission flow (**Async**, **async-Setting**), **routing**, and **PPP trace**.

1. From the **MAIN MENU**, select **Utility**, and then press **Enter**.

```

CN2510-8          CN2510-8_5631  V2.0          MAIN MENU
-----
Server Port seTting sAve [Utility] Restart Exit
Async server utilities
Enter: select  ESC: previous menu
    
```

2. From the **UTILITY MENU**, select **Monitor**, and then press **Enter**.

```

CN2510-8          CN2510-8_5631  V2.0          UTILITY MENU
-----
Ping [Monitor] Diagnostic Upgrade Quit
Monitor async server status
Enter: select  ESC: previous menu
    
```

- Each item is discussed in the following subsections.

```

CN2510-8                      CN2510-8_5631  V2.0                      MONITOR MENU
-----
[Line] Network Async async-Setting Routing PPP-Trace Quit
Monitor asynchronous port connective utilization

Enter: select  ESC: previous menu
    
```

Line

- From the **MONITOR MENU**, select **Line**, and then press **Enter**.

```

CN2510-8                      CN2510-8_5631  V2.0                      MONITOR MENU
-----
[Line] Network Async async-Setting Routing PPP-Trace Quit
Monitor asynchronous port connective utilization

Enter: select  ESC: previous menu
    
```

- The **Line** page shows the status of each port.

```

CN2510-8                      CN2510-8_5631  V2.0
-----
[Line] Network Async async-Setting Routing PPP-Trace Quit
Monitor asynchronous port connective utilization

ESC: back to menu  Enter: select

Port  Type      Idle      Status
01    PPP       39Sec    negotiation
02    TERM_BIN  39Sec    select protocol
03    RTELNET   39Sec    listen
04    ASPP      39Sec    listen
05    TERM_BIN  39Sec    select protocol
06    RAW PRN   39Sec    listen
07    FIXTTY    39Sec    #S1:listen S2:listen
08    ASPP      39Sec    listen
09    RAW UDP   39Sec    data transfer
    
```

- Type** The current operation mode of the port (set in **PORT MENU** → **Mode**).
- Idle** The amount of time the port has been idle.
- Status** The current status of the port. (If a host is connected to this port, then the host's IP address is displayed in this column.)

- Press **Esc** to return to **Line**.

Network

- From the **MONITOR MENU**, select **Network**, and then press **Enter**.

```

CN2510-8                               CN2510-8_5631  V2.0
-----
Line  [Network]  Async  async-Setting  Routing  PPP-Trace  Quit
Monitor Network protocol status
-----
ESC:  back to menu  Enter:  select
-----
ETHERNET:  Received  636                               Sent      106
PPP:       Received  0                               Sent      27
          RDiscard  0                               ErrSum    0          SDiscard  0
IP:        Received  209                              Sent      104
          RDiscard  0                               SNoRoute  0          SDiscard  0
          ErrHeader 0                               ErrProto  0          ErrAddr   0
ICMP:      Received  9                               Sent      0
          REchoReq  0                               SEchoReq  0
          REchoRply 0                               SEchoRply 0
UDP:       Received  4                               Sent      18
          ErrHeader 0                               ErrPorts  0
TCP:       Received  55                              Sent      86
          ErrHeader 0                               ErrPorts  0          ReSent    1
          CurrEstab 1                               Opens     0
    
```

Ethernet statistics

Received: Total number of input datagram packets received from the Ethernet.
Sent: Total number of output datagram packets delivered to the Ethernet.

PPP statistics

Received: Received IP datagram packets.
RDiscard: Received but discarded IP datagram packets.
ErrSum: Checksum error packets.
Sent: Sent IP datagram packets.
SDiscard: Sent but discarded IP datagram packets.

IP statistics

Received: Received IP datagram packets.
RDiscard: Received but discarded PPP datagram packets.
ErrHeader: Received but discarded IP datagram packets due to errors in IP headers.
SNoRoute: Received IP datagram packets for wrong route.
ErrProto: Locally addressed IP datagram packet received successfully but discarded for not matching one of TCP, UDP, ICMP protocols offered by CN2500.
Sent: Sent IP datagram packets.
SDiscard: Sent but discarded IP datagram packets.
ErrAddr: Sent datagram packet discarded for invalid destination IP address.

ICMP statistics

Received: Received packets of ICMP messages.
Sent: Sent packets of ICMP messages.
REchoReq: Received packets from remote Ping request.
REchoRply: Responding packets to remote Ping request.
SEchoReq: Received packets from local ping request.
SEchoRply: Responding packets to local ping request.

UDP statistics

- Received:** Received UDP datagram packets.
- ErrPorts:** Received UDP datagram packets with invalid destination port.
- ErrHeader:** Received UDP datagram packet with incorrect header.
- Sent:** Sent UDP datagram packets.

TCP statistics

- Received:** Total received packets of segments, including error packets.
- ErrHeader:** Error packets (e.g., bad TCP checksums).
- CurrEstab:** The counter of TCP connections for which the current state is either ESTABLISHED or CLOSE-WAIT.
- ErrPorts:** Received TCP datagram packets with invalid destination port.
- Opens:** TCP connections.
- Sent:** Total sent packets, including those on current connections.
- ReSent:** Retransmitted packets.

2. Press **Esc** to return to **Network**

Async

1. From the **MONITOR MENU**, select **Async**, and then press **Enter**.

```

CN2510-8                      CN2510-8_5631  V2.0                      MONITOR MENU
-----
Line Network  [Async]  async-Setting  Routing  PPP-Trace  Quit
Monitor asynchronous port line status
Enter: select  ESC: previous menu
    
```

```

CN2510-8                      CN2510-8_5631  V2.0                      MONITOR MENU
-----
Line Network  [Async]  async-Setting  Routing  PPP-Trace  Quit
Monitor asynchronous port line status
ESC: back to menu  Enter: select

Port TXTotalCnt  RxTotalCnt  TXBuf  RXBuf  TXAvg  RXAvg  DTR  RTS  DSR  CTS  DCD
01  180          0          0      0      0      0   ON  ON  --- OFF ---
02  21          0          231    0      0      0   ON  ON  --- OFF ---
03  0           0          0      0      0      0   OFF ON  --- OFF ---
04  0           0          0      0      0      0   OFF ON  --- OFF ---
05  21          0          231    0      0      0   ON  ON  --- OFF ---
06  0           0          0      0      0      0   ON  ON  --- OFF ---
07  4           0          0      0      0      0   OFF ON  --- OFF ---
08  0           0          0      0      0      0   OFF ON  --- OFF ---
09  0           0          0      0      0      0   ON  ON  --- OFF ---
10  21          0          231    0      0      0   ON  ON  --- OFF ---
    
```

- TXTotalCnt:** Total transmitted characters.
- RXTotalCnt:** Total received characters.
- TXBuf:** Queued data bytes in the transmit raw buffer.
- RXBuf:** Received data bytes in the receiving raw buffer.
- TXAvg:** Current approx. characters per second transmit rate.
- RXAvg:** Current approx. characters per second receiving rate.
- DTR:** Current DTR status.
- RTS:** Current RTS status.
- DSR:** Current DSR status.
- CTS:** Current CTS status.
- DCD:** Current DCD status.

2. Press **Esc** to return to **Async**.

Routing

- From the **MONITOR MENU**, select **Routing**, and then press **Enter**.

```

CN2510-8                               CN2510-8_5631  V2.0
-----
Line  Network  Async  async-Setting  [Routing]  PPP-Trace  Quit
Monitor current routing table

ESC: back to menu  Enter: select

Iface  Destination  Gateway/HA  Netmask  Metric  Flag  Use
eth0   0.0.0.0      192.168.1.3  0.0.0.0  15      UGT+  0
eth0   201.2.2.0    203.67.6.251 255.255.255.0 1  UGT  0
eth0   203.65.66.0  203.67.6.252 255.255.255.0 2  UGT  0
eth0   0.0.0.0      203.67.6.254 0.0.0.0  1  UGT  9
eth0   192.168.0.0  192.168.2.180 255.255.0.0 1  U  389
lo17   192.168.2.180 *  *  0  UH

```

Iface: Name of the physical network interface.

Destination: Network or host that the router allows you to connect to.

Gateway: IP Address of the gateway you configured for this route. If you are directly connected, this is a local address. Otherwise, it is the address of the machine through which packets must be routed.

Netmask: Network pattern of the gateway.

Metric: Number of hops to the destination.

Flags: State of the route. Valid states are:

- U up
- D down
- G route to a gateway
- H route to a host
- T setting in route table
- R dynamic by RIP

Use: Correct number of packets being sent in this route.

- Press **Esc** to return to **Routing**.

PPP-Trace

- From the **MONITOR MENU**, select **PPP-Trace**, and then press **Enter**.

```

CN2510-8                               CN2510-8_5631  V2.0  MONITOR MENU
-----
Line  Network  Async  async-Setting  Routing  [PPP-Trace]  Quit
Trace PPP protocol connect messages

Enter: select  ESC: previous menu

```

- Use the arrow keys to select the port you wish to trace, and then press **Enter** to select.

```

CN2510-8          CN2510-8_5631  V2.0
-----
Line  Network  Async  async-Setting  Routing  [PPP-Trace]  Quit
Trace PPP protocol connect messages
ESC: back to menu  Enter:  select

+-----+
| Select port:                                     |
| *01   02   *03   04   05   *06   07   08       |
| 09   10   [ 11]  12   13   14   *15   16       |
| Enter: select   ESC: cancel   SPACE: start     |
+-----+

```

- After selecting the ports that need monitoring, press **Space** to start.

```

CN2510-8          CN2510-8_5631  V2.0
-----
Line  Network  Async  async-Setting  Routing  [PPP-Trace]  Quit
Trace PPP protocol connect messages
ESC: back to menu  Enter:  select

TRACE PORTs: 01
P01 state: LCP Req-Sent
P01 send: C0210145001C010405DC0206000000000304C0230506BE2B92D707020802

```

PPP states for the selected ports are shown. LCP (Link Control Protocol), which is an essential part of the PPP link, is used for establishing, configuring, and testing the data link connection.

- Press **Esc** to return to **PPP-Trace**.

Diagnostic

CN2510 Diagnostic Utility, which is used to test async ports, Ethernet controllers, and printer ports, supports the following functions.

- Async port controller and internal loop-back test.
 - Ethernet controller, internal and external loop-back test.
 - Printer port test.
- From the **UTILITY** menu, select **Diagnostic**, and then press **Enter**.

```

CN2510-8          CN2510-8_5631  V2.0          UTILITY MENU
-----
Ping  Monitor  [Diagnostic]  Upgrade  Quit
Loopback test and self-diagnose
Enter: Select   ESC: previous menu

```

- If any of these tests fails, contact Moxa to request repair services.

```

CN2510-8                               CN2510-8_5631   V2.0
-----
Ping Monitor  [Diagnostic] Upgrade  Quit
Loopback test and self-diagnose

ESC: back to menu   Enter: select

Asynchronous port controller test... OK.
Asynchronous port loopback test... OK.
Ethernet port controller test... OK.
Ethernet port 1 controller loopback test... OK.
Ethernet port 1 transceiver loopback test... OK.
    
```

- Press **Esc** to restart the system.

Upgrade

The operating system in CN2510 is kept in the Flash ROM. It can be upgraded using the Windows Utility, from a locally connected CONSOLE Terminal using XMODEM protocol, or from a Unix host using RCP protocol.

Upgrading with the Windows Utility

One of the main features provided by the Windows Utility is to upgrade firmware. If the CN2510 is connected to a Windows network, this is the simplest method available for upgrading the firmware.

- Run Upgrade .exe from the CN2510 CD.

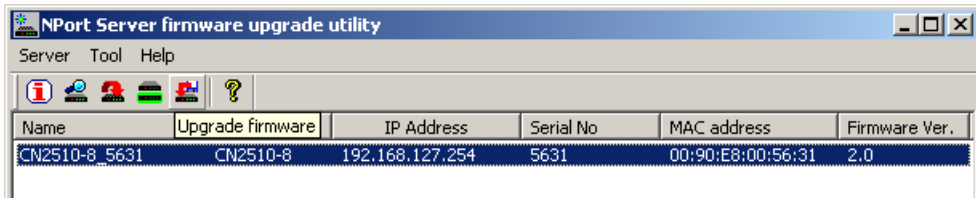

- Select the CN2510 server by clicking the  button on the toolbar. If the CN2510 server is at a remote site, use  to add it to the list.

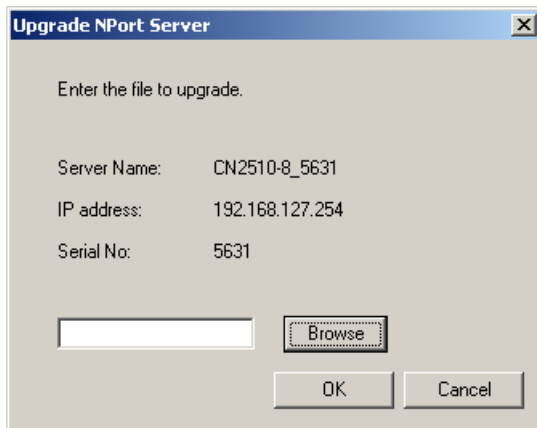

- Specify the new firmware file used to upgrade. Click on **OK** to start.

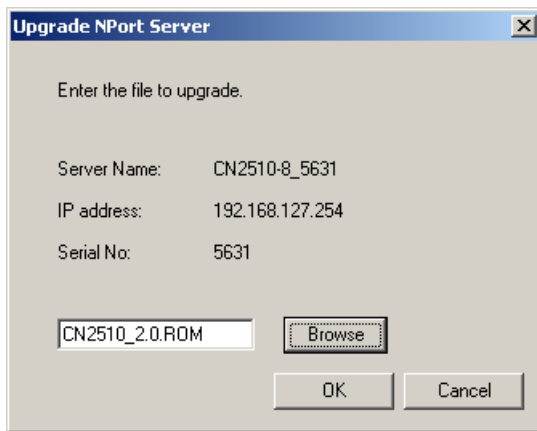

- When the **Download ok!** window appears, click on **OK**.

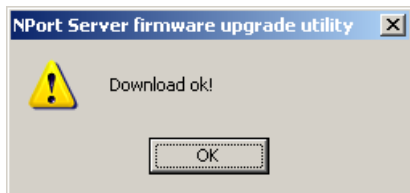
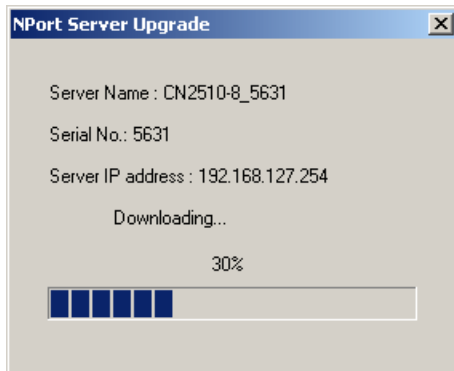

Console Terminal Upgrade

- Run **Start** → **Programs** → **PComm Terminal Emulator**. (If you cannot find the software on your computer, install PComm Lite from the CN2510 CD, and then run the program.)

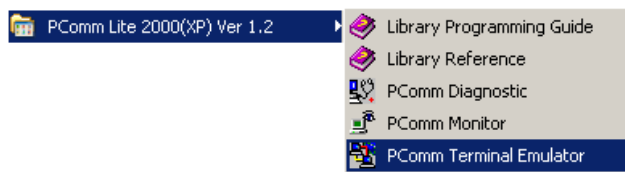

- Use an RJ45-DB9 female cable to connect to the console port, and then turn on CN2510. Start the PComm Terminal program and then open a new connection.

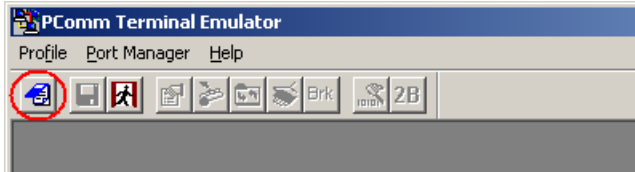

- On the **Communication Parameter** page, select **COM2** for **Ports**, **115200** for **Baud Rate**, **8** for **Data Bits**, **None** for **Parity**, and **1** for **Stop Bits**.

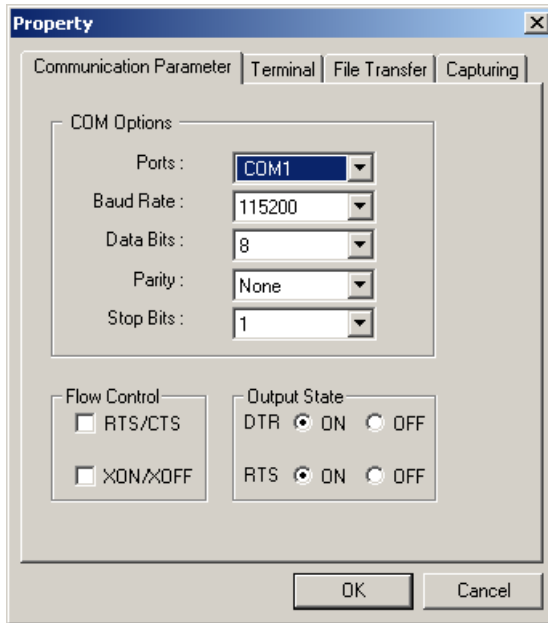

- On the **Terminal** page, select **VT100** for **Terminal Type**, and then press **Enter**.

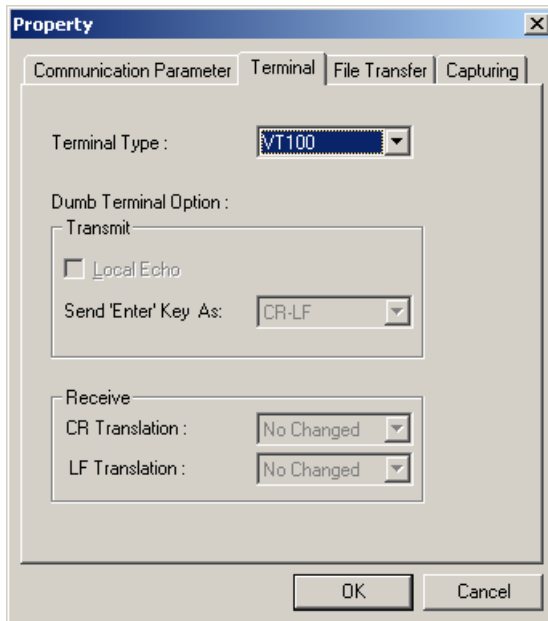

- Type **1** to choose **ansi/VT100** terminal type, and then press **Enter** to enter the **MAIN MENU**.

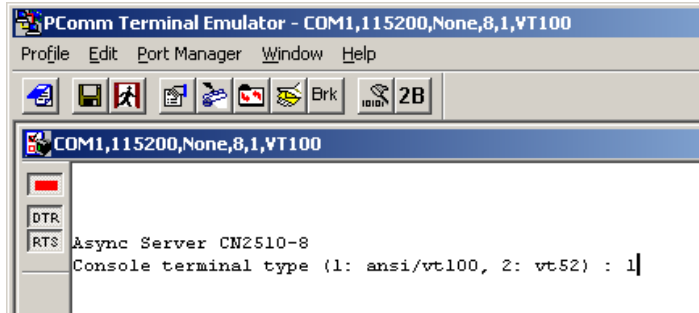

- Use the following keystrokes to navigate CN2510's console utility.

Action	Key
Move	[Up/Down/Left/Right] Arrow Key or [Tab] Key
Jump to next menu, or Select item	[Enter] Key
Return to previous menu, or Close pop up selector	[Esc] Key
Shortcut Key	Capitalized letter of the word

Upgrading through the Serial Console

- From the **MAIN MENU**, select **Utility**, and then press **Enter**.

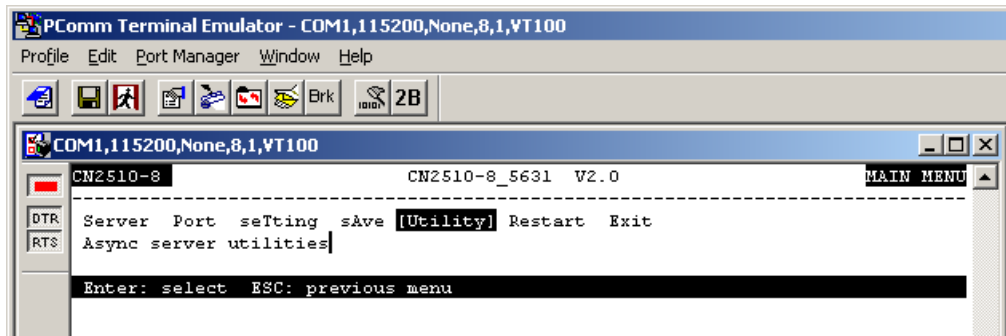

- From the **UTILITY MENU**, select **Upgrade**, and then press **Enter**.

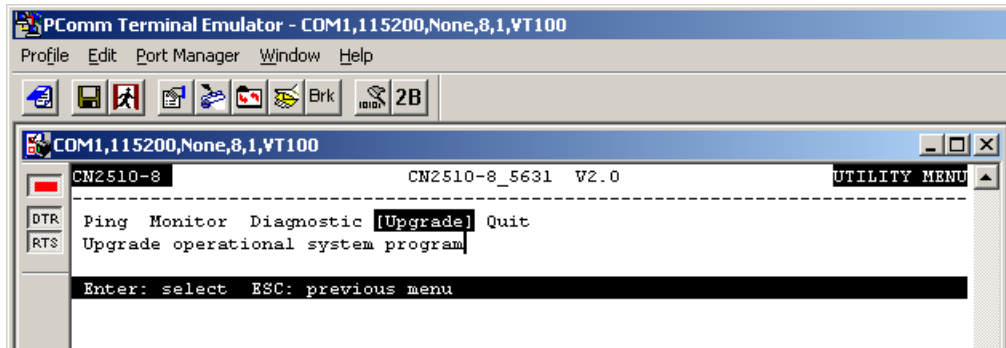

3. Select **Console port (using XMODEM)** for **Upgrade type**, and then press **Ctrl-U** to start.

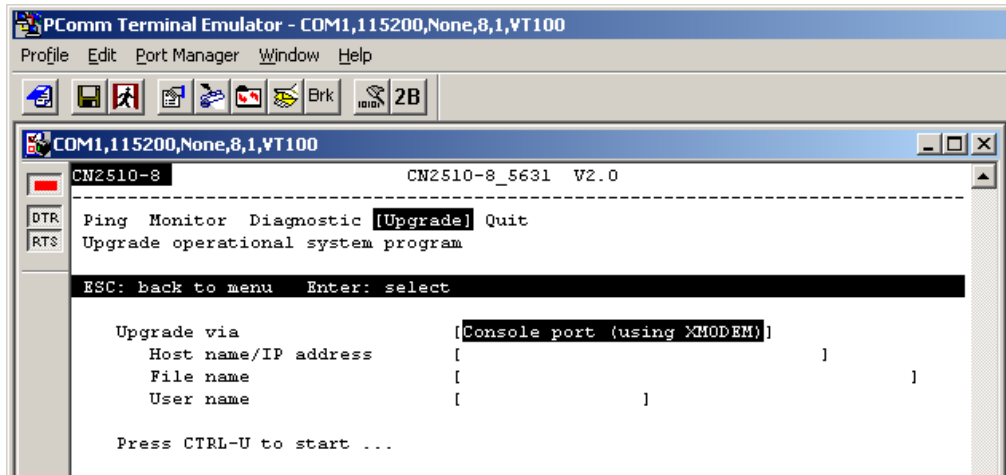

4. When you see **Start loading file ...** near the bottom of the screen, click on the **Port Manager** menu.

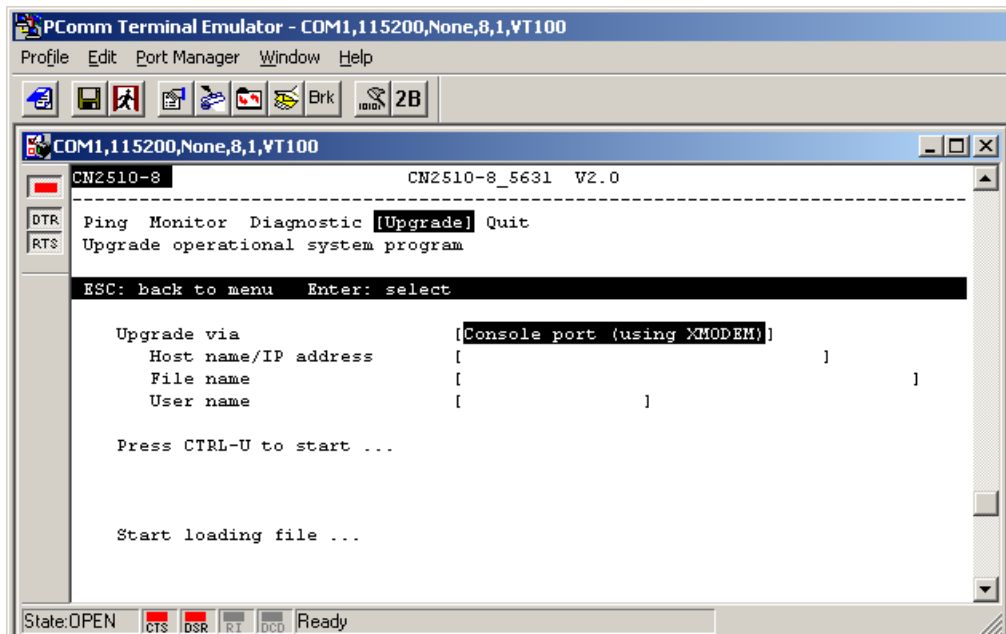

5. Select **Port Manager** → **File Transfer** from the menu bar.

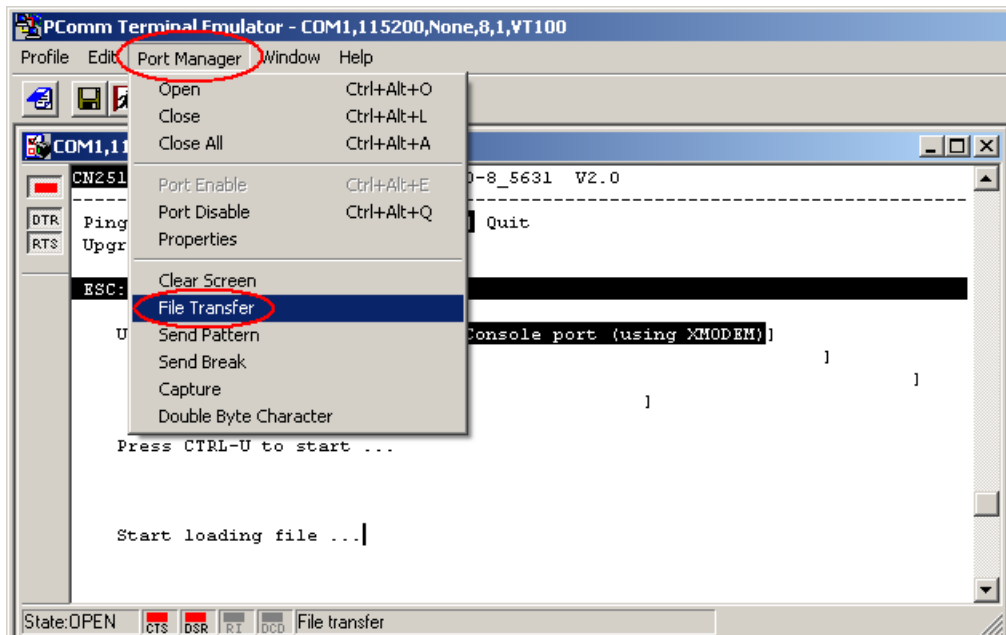

6. In the File Transfer window select **XModem-Checksum** for **Protocol** and **Transmit** for **Direction**, and then click on **OK**. The file will be transmitted to the CN2510.

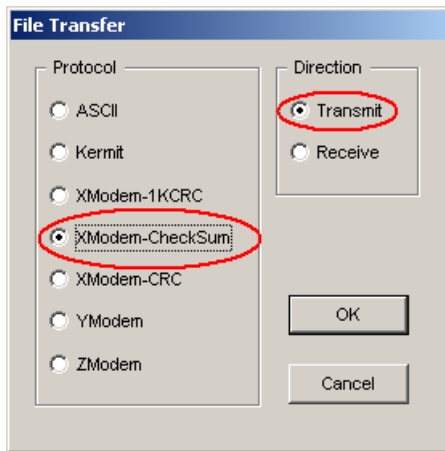

7. Locate the upgrade file, CN2510_2.ROM for example, and then click on **Open** to transfer the firmware to the CN2510.

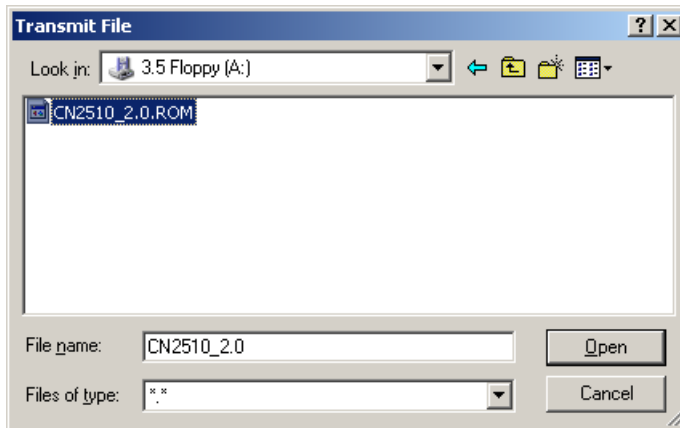

8. The CN2510 will store the new firmware in its Flash ROM, and then restart the entire system, completing the Firmware Upgrade procedure.

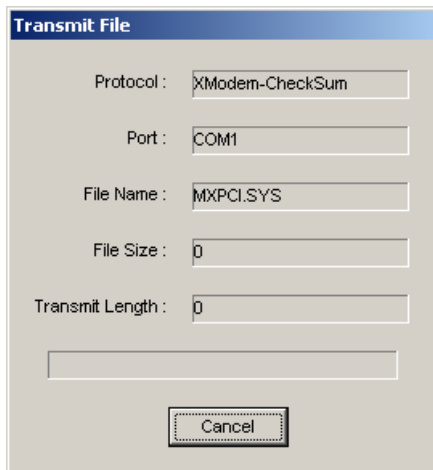

Remote RCP Upgrade

RCP (Remote Copy Program) is the Unix utility for copying files over the Ethernet. RCP allows transparent copying of files between hosts, without the need to enter passwords. This can be done using the security file `.rhosts`.

NOTE The format of RCP is as follows: `rcp from to`
 The *from* and *to* arguments can either be specified as local files or remote files. To specify a remote file, use the format: `user@hostname:filename`. If the remote login ID is identical to the local login ID, then `user@` can be omitted (i.e., only `hostname:filename` is required).

NOTE The security file `.rhosts` is a plain text file that must reside in the local user's home directory, and must be owned by that user. This file identifies those users who are "equivalent" to the local user, and are given access without needing to enter a password.

NOTE The file must contain at least a host, and if the login ID is different on the remote host, it must also contain the login ID. This sample `.rhosts` file is for the user `john` on the host `sun`. The following three accounts are considered “equivalent” accounts. The user has accounts on `moxa1` and `moxa3` with the same login ID, and has an account on `moxa2` as `johnwu`.

```
# This comment line is ignored by the operating system.
Moxa1.com.tw john
Moxa2.com.tw johnwu
Moxa3.com.tw john.
```

1. Login to your UNIX/LINUX host. For example, login to 203.67.8.22 as user “john”.
2. Copy the CN2510 firmware file, e.g., “CN2510.rom”, to the current directory.
3. Create a file named `.rhosts` in this directory. Enter CN2510’s IP address, e.g., 192.168.205.21, in the `.rhosts` file, or enter CN2510’s domain name if it’s defined in your `/etc/hosts` file.
4. Telnet CN2510’s IP address.
5. After entering CN2510’s **MAIN MENU**, select **Utility → Upgrade**.

```
CN2510-8 CN2510-8_5631 V2.0 UTILITY MENU
-----
Ping Monitor Diagnostic [Upgrade] Quit
Upgrade operational system program
Enter: select ESC: previous menu
```

6. In the **Upgrade via** column, select **Network host (using RCP)**.

```
CN2510-8 CN2510-8_5631 V2.0
-----
Ping Monitor Diagnostic [Upgrade] Quit
Upgrade operational system program
ESC: back to menu Enter: select
+-----+
Upgrade via [Console port ( | Console port (using XMODEM) |
Host name/IP address [ | Network host (using RCP) |
File name [ |
User name [ |
Press CTRL-U to start ...
```

7. In **Host name/IP address**, enter the IP address of the UNIX/LINUX host.
8. In **File name**, enter the CN2510 firmware file name in the UNIX/LINUX host.
9. In **User name**, enter the user name for logging into the UNIX/LINUX host.
10. Press **CTRL-U** to start.
11. After downloading, CN2510 will restart the system.

```
CN2510-8 CN2510-8_5631 V2.0
-----
Ping Monitor Diagnostic [Upgrade] Quit
Upgrade operational system program
ESC: back to menu Enter: select
Upgrade via [Network host (using RCP) ]
Host name/IP address [203.67.8.22 ]
File name [/home/john/cn2510.rom ]
User name [john ]
Press CTRL-U to start ...
```

Export

Settings can be exported to a file to backup the configuration, or to set up another CN2510 with the same configuration. There are two types of exported file settings: Console Terminal or Remote RCP.

Console Terminal Export

1. Run **Start** → **Programs** → **PComm Terminal Emulator**. Follow the steps given earlier to enter the **MAIN MENU**.
2. From the **MAIN MENU** select **seTting**, and then press **Enter**.

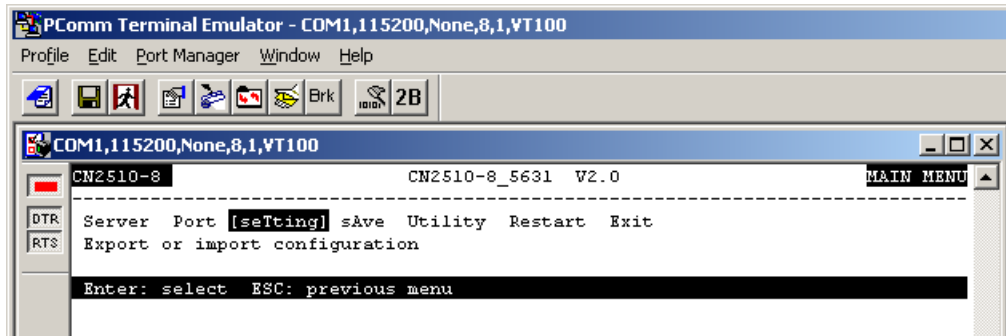

3. From the **SETTING MENU** select **Export**, and then press **Enter**.

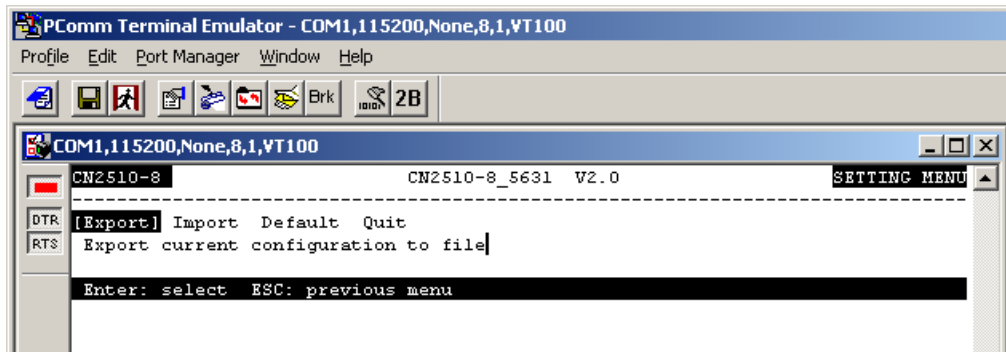

- 4. Select **Console port (using XMODEM)** for upgrade type, and then press **Ctrl-U** to start.

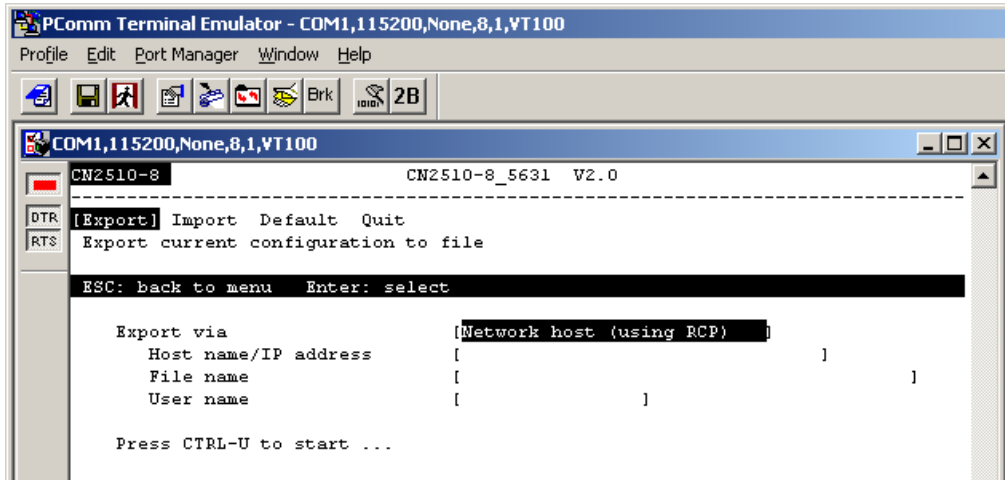

- 5. When you see **Start loading file ...** near the bottom of the screen, click on the **Port Manager** menu.

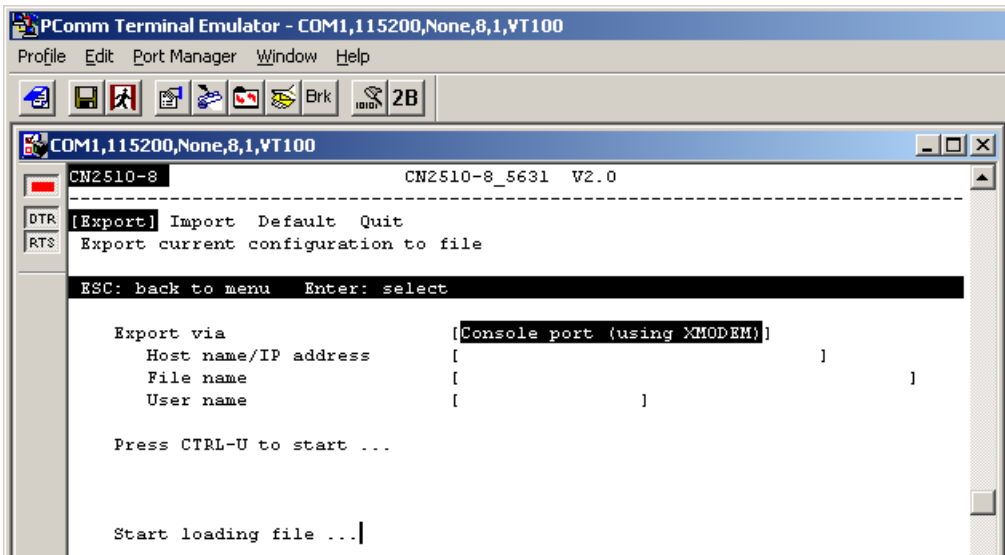

- 6. Select **Port Manager** → **File Transfer** from the menu.

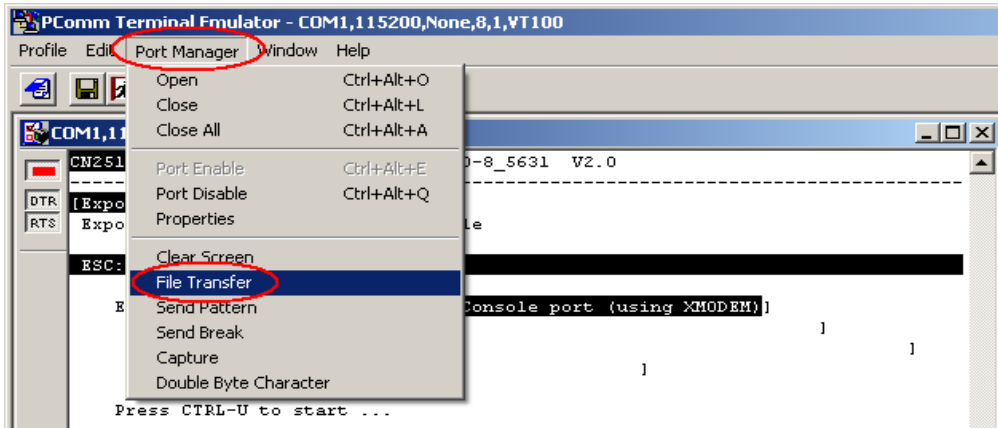

- 7. In the **File Transfer** window select **XModem-Checksum** for **Protocol**, and **Receive** for **Direction**. Selecting **OK** causes the terminal to receive settings from the CN2510.

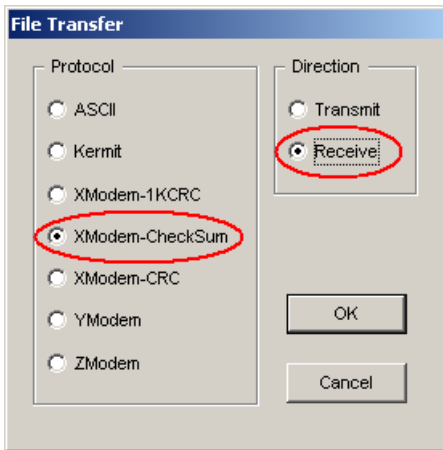

- 8. Choose the backup filename, CN2510.bak for example, and then click on **Save**.

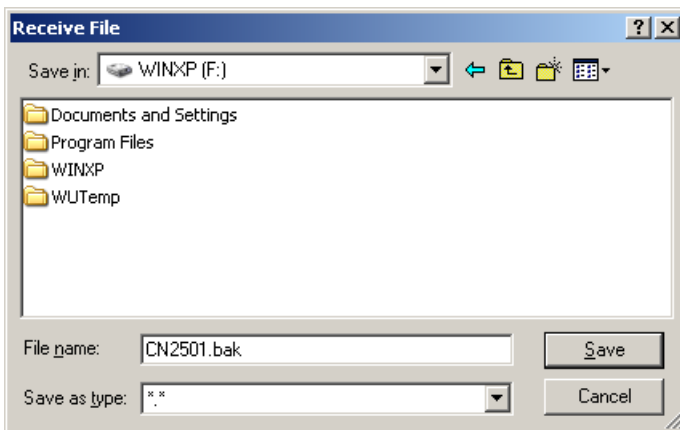

- 9. CN2510 will export settings to the file.

Remote RCP Export

As we pointed out earlier, RCP is a file transfer protocol that does not require a password.

1. Login to your UNIX/LINUX host. For example, login to 203.67.8.22 as user john.
2. Create a file named .rhosts in this directory. Enter CN2510's IP address, e.g., 192.168.205.21, or CN2510's domain name (if it's defined in your /etc/hosts file), in the .rhosts file.
3. Telnet CN2510's IP address.
4. After entering CN2510's **MAIN MENU**, select **setting** → **Export**.
5. In the **Export via** column, select **Network host (using RCP)**.
6. Enter the UNIX/LINUX host's IP address for **Host name/IP address**.
7. Enter CN2510's firmware file name on the UNIX/LINUX host for **File name**.
8. Enter the user name required to login to the UNIX/LINUX host for **User name**.
9. Press **CTRL-U** to start.

```

CN2510-8                               CN2510-8_5631  V2.0
-----
[Export] Import Default Quit
Export current configuration to file

ESC: back to menu  Enter: select

Export via                               [Network host (using RCP)      ]
Host name/IP address                     [203.67.8.22                  ]
File name                                 [/home/john/cn2510.rom        ]
User name                                 [john                          ]

Press CTRL-U to start ...
    
```

Import

Saved settings can be imported back to the CN2510. There are two settings to choose from for importing from a file, **Console Terminal** or **Remote RCP**.

Console Terminal Import

1. Run **Start** → **Programs** → **PComm Terminal Emulator**. Follow the steps given earlier to enter the **MAIN MENU**.
2. From the **MAIN MENU**, select **seTting**, and then press **Enter**.

The screenshot shows a window titled "PComm Terminal Emulator - COM1,115200,None,8,1,VT100". The terminal content is as follows:

```

COM1,115200,None,8,1,VT100
CN2510-8                               CN2510-8_5631  V2.0
-----
Server Port [seTting] sAve Utility Restart Exit
Export or import configuration

Enter: select  ESC: previous menu
    
```

- From the **SETTING MENU**, select **Import**, and then press **Enter**.

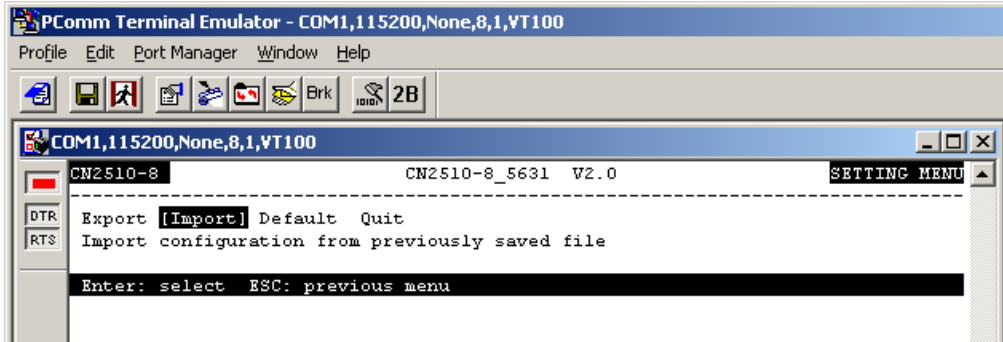

- Select **Console port (using XMODEM)** for **Import type** and then press **Ctrl-U** to start.

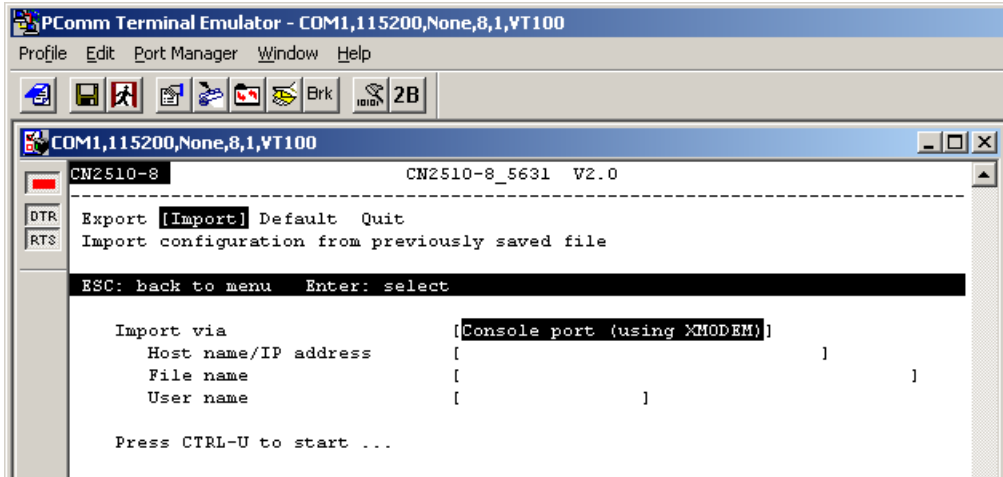

- When you see **Start loading file ...** near the bottom of the screen, click on the **Port Manager** menu.

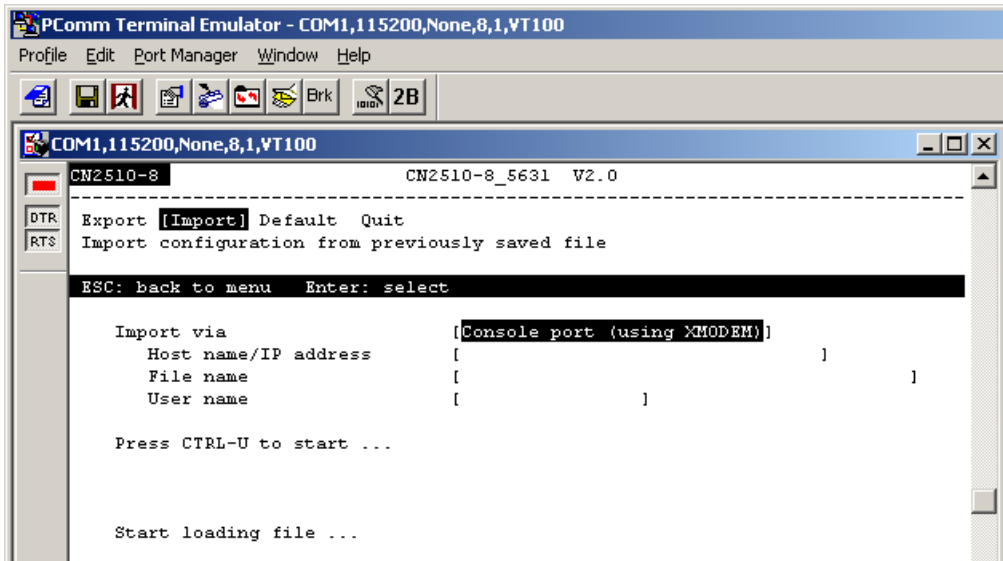

- 6. Select **Port Manager** → **File Transfer** from the menu.

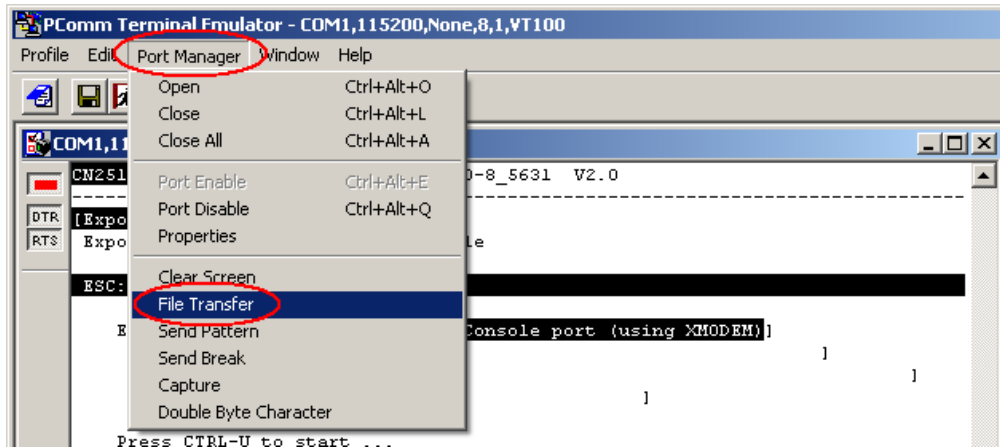

- 7. In the **File Transfer** window select **XModem-Checksum** for **Protocol** and **Transmit** for **Direction**. This causes the file to be sent from the terminal to CN2510. Click on **OK**.

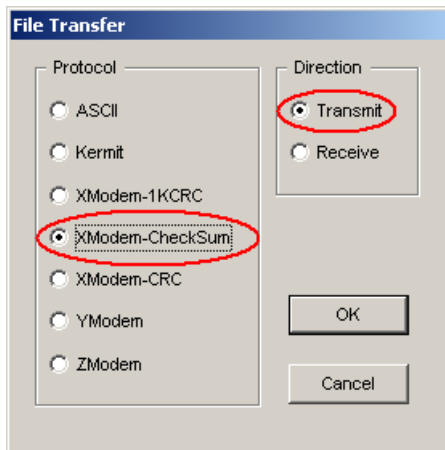

- 8. Choose the backup filename, CN2510.bak for example, and then click on **Open**.

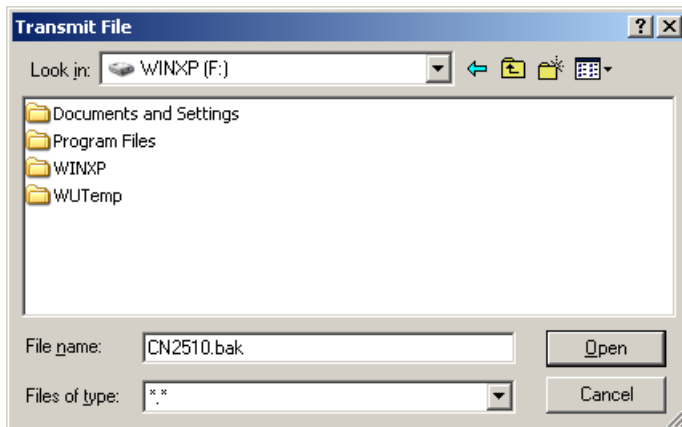

- 9. CN2510 will import settings from the file.

Remote RCP Import

As we pointed out earlier, RCP is a file transfer protocol that does not require a password.

1. Login to your UNIX/LINUX host. For example, login to 203.67.8.22 as user john.
2. Create a file named .rhosts in this directory. Enter CN2510's IP address, e.g., 192.168.205.21, or CN2510's domain name (if it's defined in your /etc/hosts file), in the .rhosts file.
3. Telnet CN2510's IP address.
4. After accessing CN2510's **MAIN MENU**, select **seTting** → **Import**. In **Import via** column, select **Network host (using RCP)**.
5. Enter the UNIX/LINUX host's IP address for Host name/IP address.
6. Enter CN2510's firmware file name on the UNIX/LINUX host for **File name**.
7. Enter the user name required to login to the UNIX/LINUX host for **User name**.
8. Press **CTRL-U** to start.

```

CN2510-8                               CN2510-8_5631  V2.0
-----
Export  [Import]  Default  Quit
Import configuration from previously saved file

ESC: back to menu  Enter: select

Import via                [Network host (using RCP)      ]
  Host name/IP address    [203.67.8.22                ]
  File name               [/home/john/cn2510.rom      ]
  User name               [john                      ]

Press CTRL-U to start ...
    
```

Default

CN2510 can restore default settings if necessary. Note that the IP address will not be changed to default.

1. From the **MAIN MENU** select **seTting**, and then press **Enter**.

```

CN2510-8                               CN2510-8_5631  V2.0                               MAIN MENU
-----
Server Port [seTting]  sAve  Utility  Restart  Exit
Export or import configuration

Enter: select  ESC: previous menu
    
```

2. From the **SETTING MENU**, select **Default**, and then press **Enter**.

```

CN2510-8                               CN2510-8_5631  V2.0                               SETTING MENU
-----
Export  Import  [Default]  Quit
Load the factory setting

Enter: select  ESC: previous menu
    
```

3. Press **Enter** to confirm that you wish to erase all settings and restore the default settings.
Press any key to cancel.

```
CN2510-8          CN2510-8_5631  V2.0
-----
Export  Import  [Default]  Quit
Load the factory setting
ESC:  back to menu  Enter:  select

+-----+
|Enter to load factory setting, other key to cancel|
+-----+
```

A

Troubleshooting

In this appendix, we give solutions to various problems you may come across when using CN2510.

The following topics are covered in this appendix:

- Console Terminal Problems**
- Terminal Port Problems**
- How to Save CN2510's Parameters**
- ASPP Port Problems**
- SLIP/PPP Connection Problems**
- RADIUS Problems**

Console Terminal Problems

Problem: No message is displayed on the console terminal.

Solutions:

- Check to see if the terminal is set to 115200 bps, 8 data bits, no parity, 1 stop bit.
- Check to see if the RS-232 cable is wired correctly. The console needs CTS/DCD signals to trigger. Refer to the “Cable Wiring” section in Appendix D.
- The console may be blocked waiting for an event. Press ESC to try unblocking.

Problem: Garbage characters are displayed on the console terminal.

Solutions:

- Check to see if the terminal is set to 115200 bps, 8 data bits, no parity, 1 stop bit.
- Check to see if terminal type setting is correct. The console only accepts ansi/vt100 or vt52.
- Press Ctrl-L to refresh the display.

Question: How can I restore CN2510 to the factory default settings?

Solution:

- After entering the Console window, select setting → Default, and then press Enter. The CN2510 will be restored to the factory default settings.

```

CN2510-8                               CN2510-8_5631  V2.0                               MAIN MENU
-----
Server Port [seTting] sAve Utility Restart Exit
Export or import configuration
Enter: select  ESC: previous menu

```

```

CN2510-8                               CN2510-8_5631  V2.0
-----
Export Import [Default] Quit
Load the factory setting
ESC: back to menu  Enter: select

+-----+
|Enter to load factory setting, other key to cancel|
+-----+

```

Question: If I forget the password for my CN2510, what should I do?

Solution:

- Press the Reset button on the CN2510's front panel for more than 5 seconds. The password stored in the Flash ROM will be erased. In addition, all settings will be reset to their factory default values. CN2510 will beep twice when the configuration has been reset. Refer to Chapter 1 for more details.

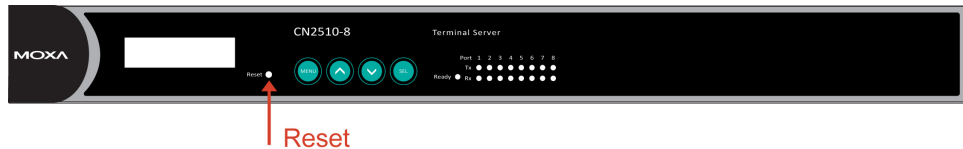

Problem: I used Telnet Console in a Windows 9x/NT environment, but I couldn't use the arrow keys to select options.

Solution:

- In Telnet, click on the **Terminal** menu, choose **Preferences**, and then select **VT100 Arrows** in the **Terminal Preferences** window. Click on **OK** to return to the **MAIN MENU**. The arrow keys should work properly now.

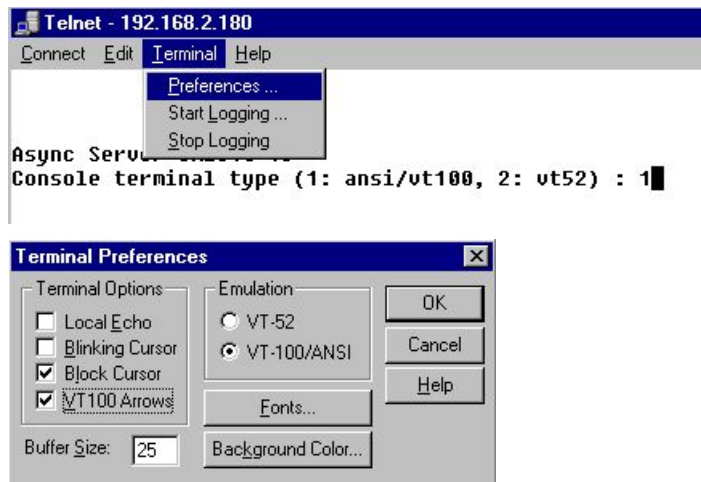

Question: My application involves connecting the console port of a CISCO router/switch to a Moxa Async Server serial port. I connect to the CISCO router/switch console by Telnet over the network from a remote site. Why does the CISCO router/switch receive two "Enter" commands even though I only pressed the "Enter" key once?

Solution:

- The "Enter" Map keys of Async server are <CR-LF>, causing the CISCO router to receive two commands instead of one.
- Access Async server.
- Access Async server serial console to change the "Map keys" type from <CR-LR> to <CR>.

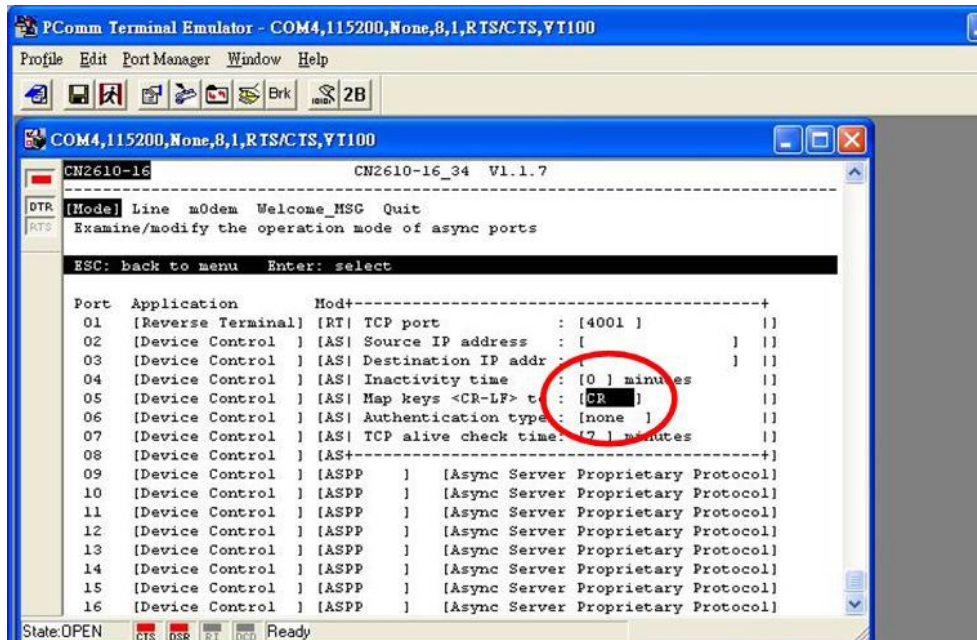

Terminal Port Problems

Problem: When a terminal is connected to one of CN2510's serial ports, no message is displayed on the terminal attached to the CN2510 terminal port when it is powered on.

Solutions:

- One of the possible reasons is that this serial port is configured to Disable mode, or to another application mode. Using the Serial Console or Telnet Console, select Port → Mode, and then move the cursor to the Application corresponding to the serial port, and change Disable to Terminal.
- Check to see if the terminal's serial port is set to the same settings as CN2510's serial port. Use Serial Console or Telnet Console, select Port → Line, and then move the cursor to the corresponding serial port, and check to see if Speed, Bits, Stop, Parity, FIFO, RTS/CTS, XON/XOFF, and Discon.ctrl settings are the same as the terminal's serial port.
- Check to see if the RS-232 cable is wired correctly. If the port is utilizing RTS/CTS hardware flow control, then the RTS, CTS pins should be included. In this case, a cable with only TxD, RxD, and GND pins will not work.
- The terminal may be unlocked by pressing [Ctrl-S] (Hex Code 0x13) if software flow control is used. Press [Ctrl-Q] (Hex Code 0x11) to relieve it.

How to Save CN2510's Parameters

Question: How can I save CN2510's parameters to recover from unexpected power failures, or to transfer the same parameters to another CN2510?

Solutions:

- After entering the Console screen, select **seTting** → **Export**, and press **Enter**. Then you can use **XMODEM** for a Windows host, or **RCP** for a UNIX host, to save the parameters to a file.

```

CN2510-8                               CN2510-8_5631  V2.0                               MAIN MENU
-----
Server Port [seTting] sAve Utility Restart Exit
Export or import configuration
Enter: select  ESC: previous menu

```

```

CN2510-8                               CN2510-8_5631  V2.0                               SETTING MENU
-----
[Export] Import Default Quit
Export current configuration to file
Enter: select  ESC: previous menu

```

```

CN2510-8                               CN2510-8_5631  V2.0
-----
[Export] Import Default Quit
Export current configuration to file
ESC: back to menu  Enter: select

Export via                               [Console port (using XMODEM)]
Host name/IP address [                               ]
File name             [                               ]
User name             [                               ]

Press CTRL-U to start ...

```

ASPP Port Problems

Problem: The application utilizing the ASPP subroutines could not connect to the CN2510.

Solutions:

- Check to see if the target port's mode is set to ASPP. The connection will fail if the port mode is set to something other than ASPP. After entering the Console screen, select **Port** → **Mode**, move the cursor to the **Application** corresponding to the serial port, and set it to **Device Control**. In the **Mode** column, select **ASPP**.
- Moxa provides example programs on the website (www.moxa.com) that can be downloaded.

SLIP/PPP Connection Problems

Problem: Cannot make a SLIP connection to a remote host.

Solutions:

- Check to see if the CN2510's SLIP port baud rate (in the **Port** → **Line** menu) is the same as the remote host's baud rate.
- Check to see if data bits = 8.
- Check to see if the XON/XOFF flow control is the same as the remote site.
- Check to see if the RS-232 cable is wired correctly. If the port is utilizing RTS/CTS hardware flow control, then the RTS, CTS pins should be included. In this case, cables with only pins 2, 3, and 7 will not work.
- Make sure there is no "getty" or other process using the SLIP port on the remote site.

RADIUS Problems

Question: What can I do if there is an authentication check failure on the radius server?

Solutions:

- Check to see if the console password is the same as the radius server's radius key.
- Make sure the password was entered correctly.
- Make sure the account and password in the login script are correct.
- If the authentication check runs for a long time and then times out, check to see if the RADIUS Server's IP is correct. E.g., set up one port as Rtelnet, telnet CN2510's TCP port from radius, and then telnet CN2510's console and check the Monitor {line} status. Check to see if the remote IP address matches the radius IP address you set in the CN2510.

Question: Why can't I compile radius software on a system running Linux Red hat 5.0?

Solutions:

Take the following steps if you compiled RADIUS2.3 on Red hat 5.0 or above:

1. Save makefile-SCO as a file named makefile-LINUX, and then modify the content as follows:

```
#
# make file for LINUX
#
```

```
LIBS = -lcrypt
include Makefile
```

2. Add two similar line to the shell program "mk_radius" at read_os "1". For example, they might appear as follows:

```
read_os
case $ans in
'1')
clear
mk_src
echo "enter lib directory"
cd lib
echo "compiling source program ...."
make
cd ..
echo "linking program ....."
make -f Makefile-LINUX;;
```

B

RADIUS Server

Managing dispersed serial lines and modem pools for large numbers of users can create the need for significant administrative support. Since modem pools are a link to the outside world, they require careful attention to security, authorization, and accounting. This can best be achieved by managing a single “database” of users, allowing for authentication (verifying user name and password) as well as configuring information which details the type of service to deliver to the user (for example: SLIP, PPP, Telnet, rlogin). Moxa CN2510 Async Server supports RADIUS protocol, which requires only one database for remote user management.

The following topics are covered in this appendix:

- ❑ **What is RADIUS?**
 - Definition
 - Client/Server Architecture
- ❑ **Setting up CN2510**
 - Setting up the RADIUS Server IP Address
 - Setting up Port Configuration
- ❑ **Setting up UNIX Hosts**
- ❑ **Setting up Windows NT Hosts**
- ❑ **Setting up Windows 2000 Hosts**
- ❑ **Setting up Windows 2003 Hosts**

What is RADIUS?

Definition

Remote Authentication Dial-up User Service, or RADIUS, is the standard for centralizing the authentication, authorization, and accounting of remote access users.

Here is a brief description of how RADIUS works: When a user dials in to a remote access device, that device communicates with the central RADIUS server to determine if the user is authorized to connect to the LAN. The RADIUS server performs the authentication and responds with the result—either accept or reject. If the user is accepted, the remote access server routes the user onto the network; if not, the RAS will terminate the user's connection. The RADIUS server also provides accounting services if supported by the remote access server.

With RADIUS, a network manager or ISP only needs to maintain a single, central database against which all remote user authentication takes place. This greatly eases the management burden associated with administering large numbers of Dial-in users.

Client/Server Architecture

RADIUS is a type of client-server software. Communication servers, such as CN2510, play an active role, whereas a RADIUS server is passive.

1. When a remote host is connected to CN2510, it is prompted to enter its user ID and password.
2. After receiving the user ID and password, CN2510 sends the information to a defined RADIUS server. Up to this point, the remote user is still unable to access the network.
3. The RADIUS server compares the user ID and password with its internal database, and then uses the internet to respond, either accepting or rejecting.
4. If CN2510 receives the "accept" message from the RADIUS server, the remote user is allowed to enter the network. Otherwise, CN2510 will wait for another try, or terminate the connection when a specified time limit has been reached.

Setting up CN2510

Setting up the RADIUS Server IP Address

1. From the **MAIN MENU**, select **Server**, and then press **Enter**.

```

CN2510-8                               CN2510-8_5631  V2.0                               MAIN MENU
-----
[Server] Port seTting sAve Utility Restart Exit
Examine/modify async server node/table configuration
Enter: select  ESC: previous menu

```

- From the **SERVER MENU**, select **Adv.**, and then press **Enter**.

```

CN2510-8          CN2510-8_5631  V2.0
-----
Info.  Lan [Adv.] Host_table Route_table User_table Quit
Examine/modify async server basic configuration

ESC: back to menu  Enter:  select

RADIUS server IP      [          ]
RADIUS key            [          ]
UDP port <1:1645 2:1812> [1]
Enable RADIUS accounting [no ]

SNMP community name  [public          ]
SNMP trap server IP address [          ]

Ethernet IP forwarding [no ] | None |
Routing protocol      [None ] | RIP-1 |
                       | RIP-2 |
TCP retransmission timeout [          ]+-----+: 50 - 60000 ms)
SIO data transfer timeout [          ] (range: 0 - 1000 ms)
    
```

- RADIUS settings.

RADIUS server IP: [RADIUS server IP address]

RADIUS key: [RADIUS password] (must be the same in the RADIUS server)

UDP port: [1/2]

Mode 1: An earlier but rather common setting is 1645. If you choose 1645, the authentication has to be set as 1645, and accounting as 1646 in the RADIUS Server.

Mode 2: The latest setting is 1812. If you choose 1812, the authentication must be set as 1812, and accounting as 1813 in the RADIUS Server.

Enable RADIUS accounting: [yes/no]

- Save, and then restart CN2510.

Setting up Port Configuration

RADIUS is effective for dial-up services. Apart from dial-in services (PPP, SLIP, Dynamic), it also supports RADIUS settings in Terminal applications and Console Management application.

Dialin/out—Dynamic Mode

```

CN2510-8          CN2510-8_5631  V2.0
-----
[Mode] Line mOdem Welcome_MSG Quit
Examine/modify the operation mode of async ports

ESC: back to menu  Enter:  select

Port Application      Mode      Description/more setting
01 [Dialin/out] [DYNAMIC ] [Auto Term/SLIP/PPP identification]
02 [Dialin/out] [DYNAMIC ] [Auto Term/SLIP/PPP identification]
03 [Dialin/out] [DYNAMIC ] [Auto Term/SLIP/PPP identification]
04 [Dialin/out] [DYNAMIC ] [Auto Term/SLIP/PPP identification]
    
```

```

+-----+
|                                     |
| Enable      Detail-setting         |
| TERM_BIN mode [yes] [Term parameters] |
| PPPD mode   [yes] [PPP parameters]   |
| SLIPD mode  [yes] [SLIP parameters]  |
|                                     |
| TERM_BIN mode [none ]                |
|                                     |
+-----+
    
```

Dialin/out—PPP/PPPD Mode

```

CN2510-8          CN2510-8_5631  V2.0
-----
[Mode] Line m0dem Welcome_MSG Quit
Examine/modify the operation mode of async ports
ESC: back to menu  Enter: select
-----
Port Application      Mode      Description/more setting
01 [Dialin/out] ] [PPP]      ] [Point-to-Point Protocol ]
02 [Dialin/out] ] [PPP]      ] [Point-to-Point Protocol ]
03 [Dialin/out] ] [PPP]      ] [Point-to-Point Protocol ]
04 [Dialin/out] ] [PPP]      ] [Point-to-Point Protocol ]
    
```

```

+-----+
| Destination IP address : [          ] |
| Source IP address     : [          ] |
| IP netmask            : [          ] |
| TCP/IP compression    : [no ]      |
| Inactivity time       : [0 ] minutes |
| Link quality report   : [no ]      |
| Outgoing PAP ID       : [          ] |
| PAP password          : [          ] |
| Incoming PAP check    : [none ]     |
|                                     |
+-----+
    
```

Dialin/out—TERM_BIN / TERM_ASC Mode

```

CN2510-8          CN2510-8_5631  V2.0
-----
[Mode] Line m0dem Welcome_MSG Quit
Examine/modify the operation mode of async ports
ESC: back to menu  Enter: select
-----
Port Application      Mode      Description/more setting
01 [Terminal] ] [TERM_ASC] ] [ASCII Terminal mode (8 sessions)]
02 [Terminal] ] [TERM_ASC] ] [ASCII Terminal mode (8 sessions)]
03 [Terminal] ] [TERM_ASC] ] [ASCII Terminal mode (8 sessions)]
    
```



```

+-----+
| Key Mapping :                               |
|   Max. Sessions      : [ 8 ]                |
|   Change Session    : [ ^T ]                |
|   Quit               : [ ^E ]                |
|   Break              : [   ]                |
|   Interrupt          : [   ]                |
|   Auto-link protocol : [ none ]             |
|   Telnet TCP port    : [ 23 ]               |
|   Primary host IP    : [                   ] |
|   Link by input IP   : [ Disable ]          |
|   Secondary host IP  : [                   ] |
|   Auto-login prompt  : [ ogin: ]           |
|   Password prompt   : [ assword: ]         |
|   Login user name    : [                   ] |
|   Login password     : [                   ] |
|   Terminal type      : [ ansi ]             |
|   Inactivity time    : [ 0 ] minutes        |
|   Authentication type : [ none ]            |
|   TCP alive check time : [ 0 ] minutes      |
+-----+

```

Console Management—RADIUS Settings

```

CN2510-8                               CN2510-8_5631  V2.0
+-----+
| [Mode] Line mOdem Welcome_MSG Quit      |
| Examine/modify the operation mode of async ports |
+-----+
| ESC: back to menu  Enter: select         |
+-----+
| Port  Application      Mode           Description/more setting |
| 01    [Reverse Terminal] [RTELNET ] [Reverse Telnet mode  ] |
| 02    [Reverse Terminal] [RTELNET ] [Reverse Telnet mode  ] |
| 03    [Reverse Terminal] [RTELNET ] [Reverse Telnet mode] |
| 04    [Reverse Terminal] [RTELNET ] [Reverse Telnet mode  ] |
| 05    [Reverse Terminal] [RTELNET ] [Reverse Telnet mode  ] |
+-----+

```

```

+-----+
| TCP port      : [ 4003 ]                   |
| Source IP address : [                   ] |
| Destination IP addr : [                   ] |
| Inactivity time : [ 0 ] minutes           |
| Map keys <CR-LF> to : [ CR-LF ]          |
| Authentication type : [ none ]            |
| TCP alive check time : [ 0 ] minutes      |
+-----+

```

Setting up UNIX Hosts

MOXA recommends the FreeRADIUS server for UNIX users. FreeRADIUS is the premiere open source RADIUS server, and is well within the top 5 RADIUS servers in use world-wide. It is suitable for embedded systems with small amounts of memory, to systems with millions of users. It is fast, flexible, configurable, and supports more authentication protocols than many commercial servers.

The server is released under the GNU General Public License (GPL), which means that it is free to download and install. FreeRADIUS can be downloaded from the following website:

<http://www.freeradius.com/>

Setting up Windows NT Hosts

Install Windows NT OPTION PACK 4.0 to Windows NT server.

1. **Start** → **Programs** → **Windows NT 4.0 Option Pack** → **Microsoft Internet Information Server** → **Management Console Manger**.

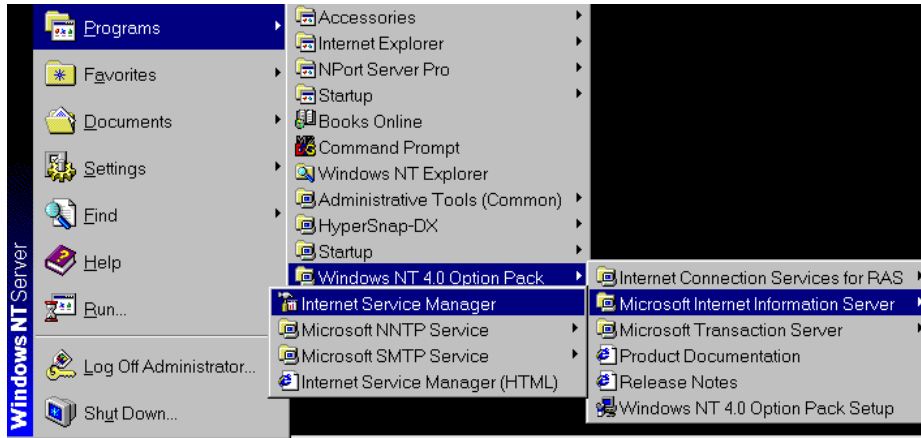

2. Click **Console Root** → **Internet Information Server** (in the left info window). Your computer's name will be visible.
3. Click **your computer name**, after which you will see **RADIUS** in the right info window.

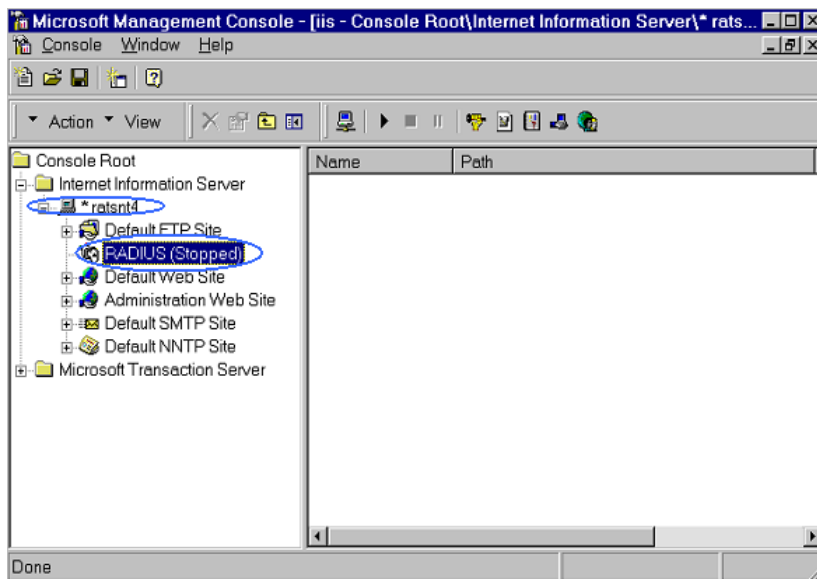

- Right click on **RADIUS** in the left info window, and then select **Properties**.

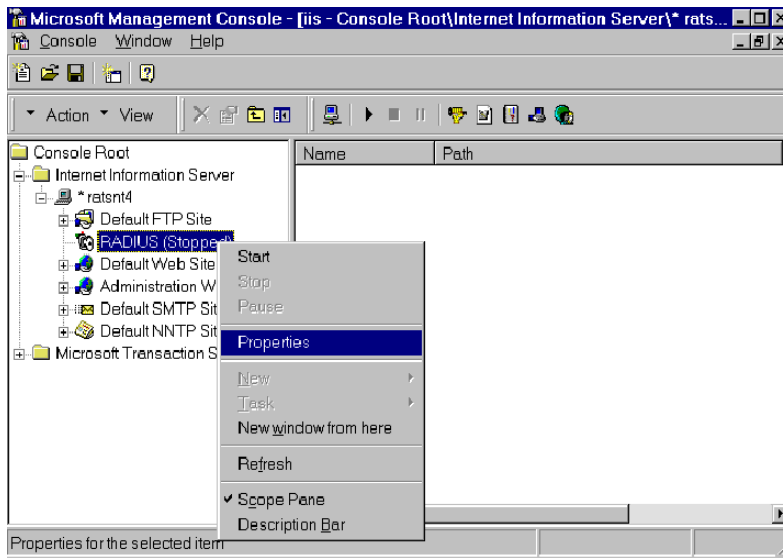

- Select **Service**. Check the **RADIUS ports**.

[Authentication] 1645
 [Accounting] 1646

- Select **Client**, and then click on **Add**. Enter CN2510's IP address in the **IP address** field. Enter CN2510's password in the **password** field. The password corresponds to the RADIUS key setting in the CN2510 Console.

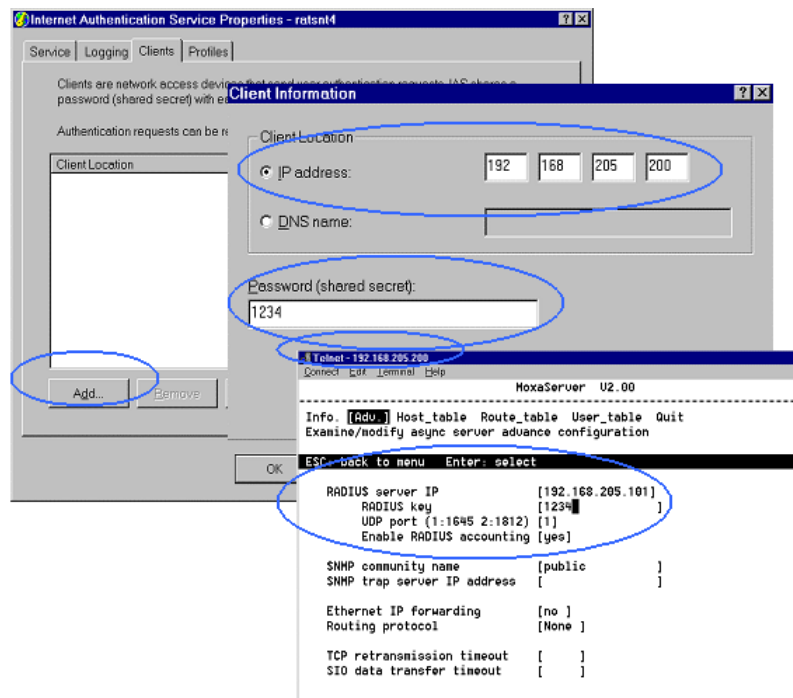

- Click **Apply**.
- Right click on **RADIUS** in the left info window, and select **Start**.
- You will now see that RADIUS is running.

Setting up Windows 2000 Hosts

1. Click on **Start** → **Programs** → **Administrative Tools** → **Routing and Remote Access**.
2. Follow the steps below to install. Right click on **Server (Local)** to select **Configure and Enable Routing and Remote Access**. Click on **Next** to continue.
3. Select **Remote access server**, and then click on **Next** to continue.

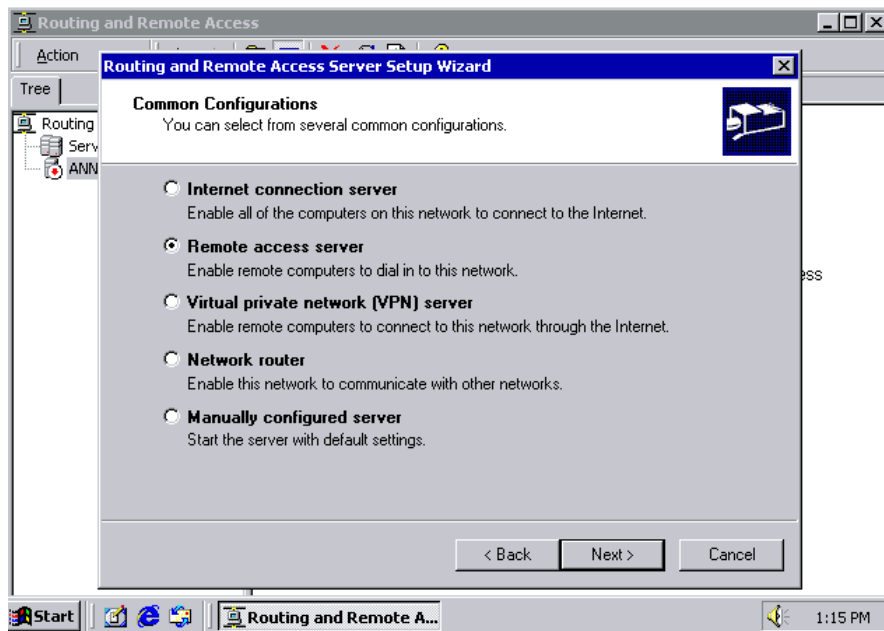

4. Select **Set up an advanced remote access server**, and then click on **Next** to continue.

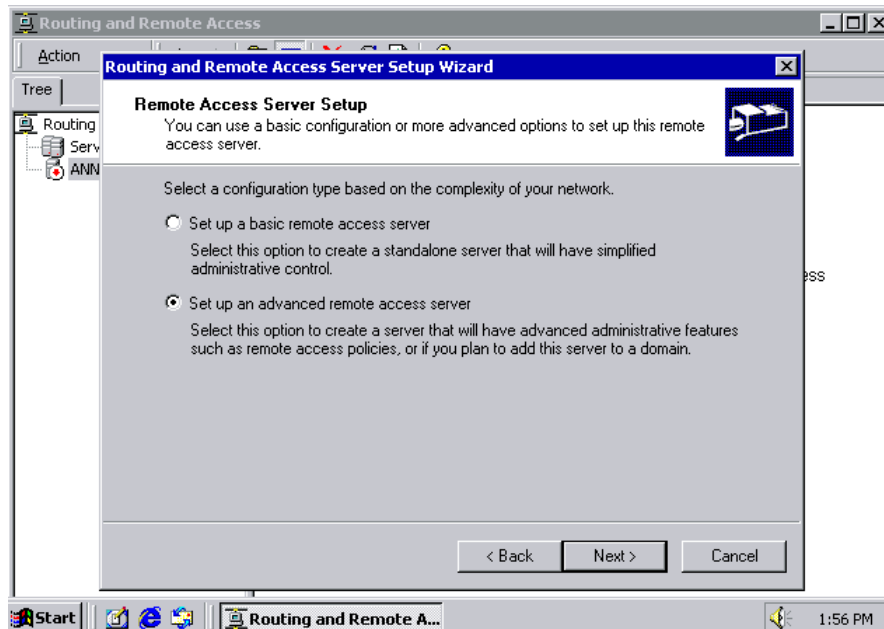

5. Select **TCP/IP** protocol, and then click on **Next** to continue.

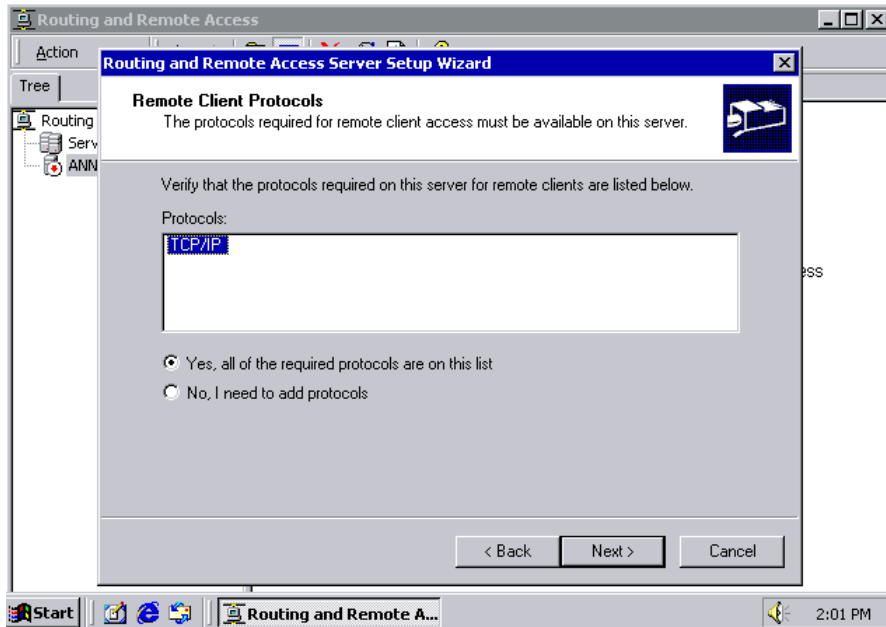

6. Specify an IP address.

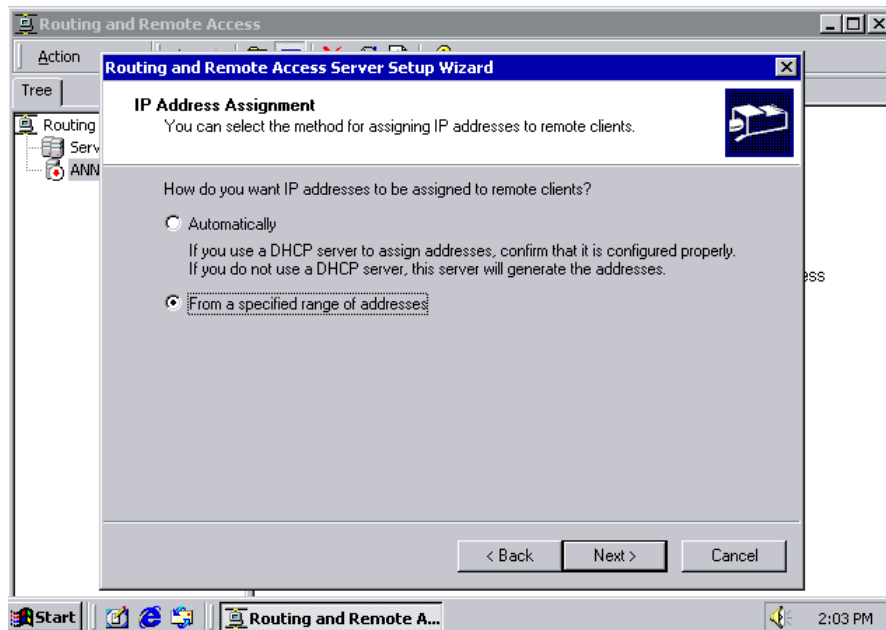

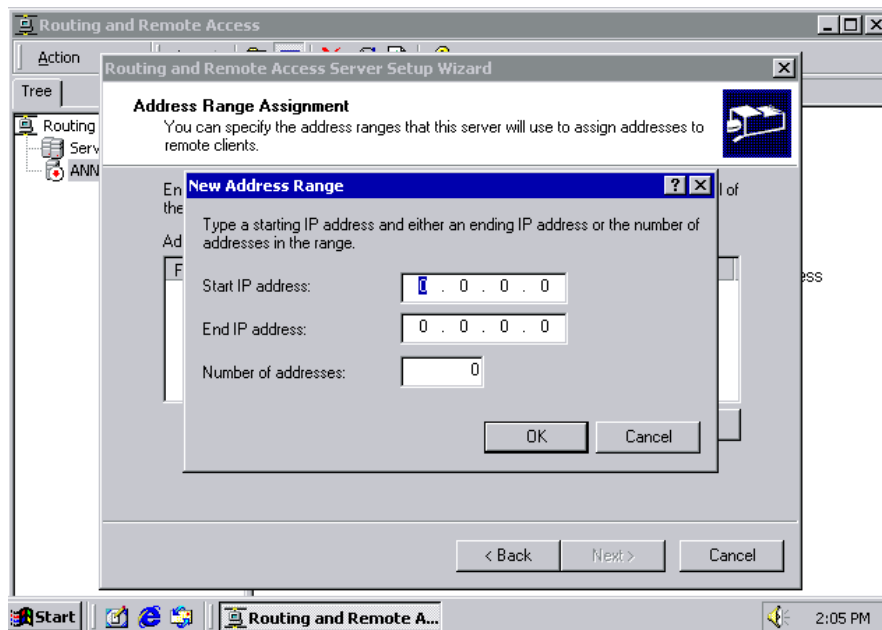

7. Select **Yes, I want to use a RADIUS server**, and then click on **Next** to start using this function.

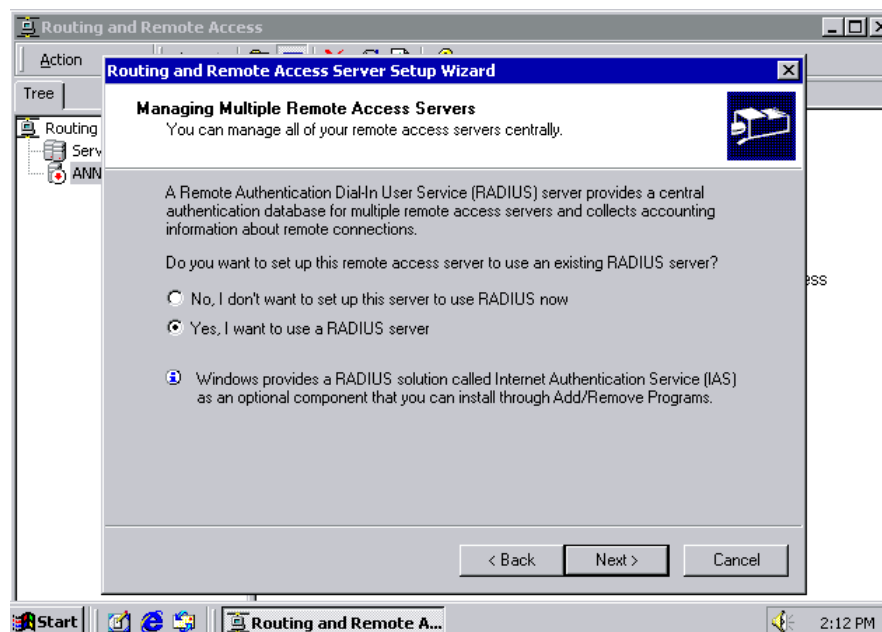

Setting up Windows 2003 Hosts

Windows 2003 uses IAS service instead of RADIUS service. For this reason, you need to install IAS service to use RADIUS with Windows 2003 (IAS service will not be installed by default).

1. Click on **Start → Add or Remove Programs → Add/Remove Windows Components**.
2. With **Windows Components** selected, choose **Network Services**.

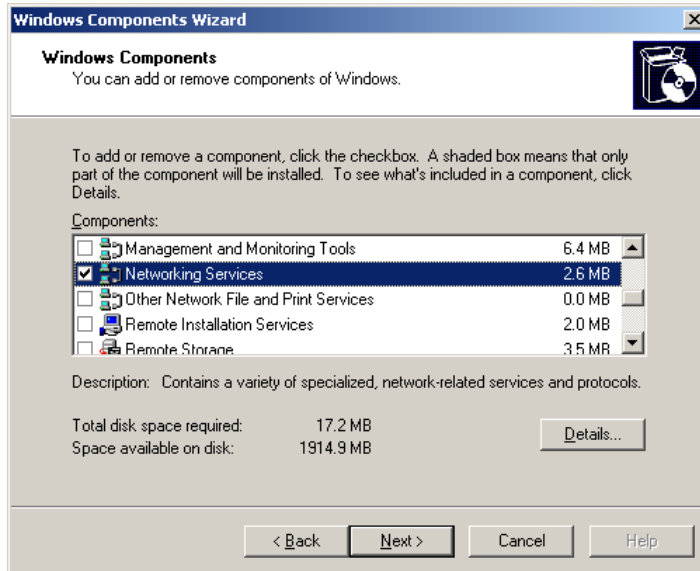

3. Select **Details**, and then **Internet Authentication Service**. Click on **OK** to continue until the installation is finished.

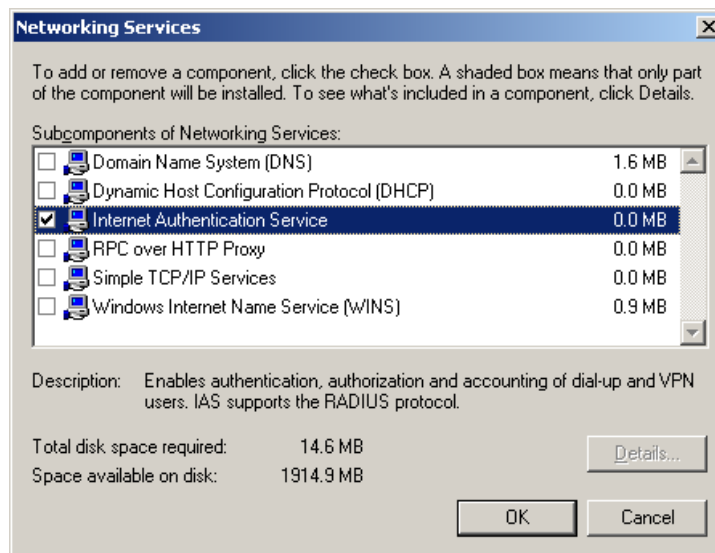

4. After the installation is finished, click on **Administrative Tools**, and run **Internet Authentication Service**. The window shown below will open.

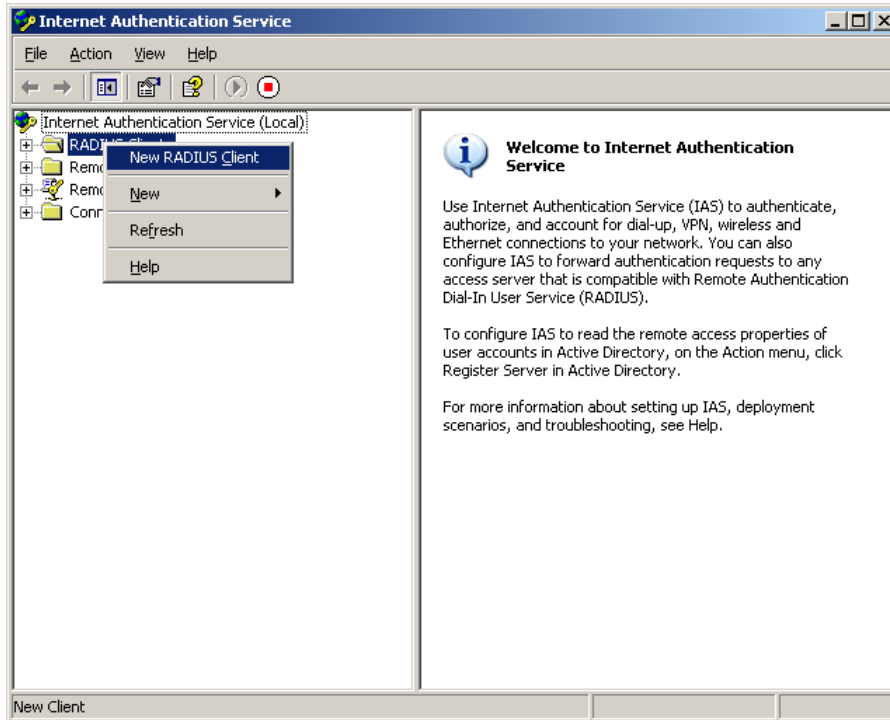

5. Select **NEW RADIUS Client** to add a new RADIUS client. You will then be able to start using this function.

SNMP Agent with MIB II

Simple Network Management Protocol agent software is built into CN2510. The software supports cold/warm start trap, line up/down trap, and RFC 1213 MIB-II. The following table lists the standard MIB-II groups, as well as the variable implementations for CN2510.

Supported SNMP variables

System MIB	Interfaces MIB	IP MIB	ICMP MIB
SysDescr	itNumber	ipForwarding	IcmpInMsgs
SysObjectID	ifIndex	ipDefaultTTL	IcmpInErrors
SysUpTime	ifDescr	ipInreceives	IcmpInDestUnreachs
SysContact	ifType	ipInHdrErrors	IcmpInTimeExcds
SysName	ifMtu	ipInAddrErrors	IcmpInParmProbs
SysLocation	ifSpeed	ipForwDatagrams	IcmpInSrcQuenchs
SysServices	ifPhysAddress	ipInUnknownProtos	IcmpInRedirects
	ifAdminStatus	ipInDiscards	IcmpInEchos
	ifOperStatus	ipInDelivers	IcmpInEchoReps
	ifLastChange	ipOutRequests	IcmpInTimestamps
	ifInOctets	ipOutDiscards	IcmpTimestampReps
	ifInUcastPkts	ipOutNoRoutes	IcmpInAddrMasks
	ifInNUcastPkts	ipReasmTimeout	IcmpOutMsgs
	ifInDiscards	ipReasmReqds	IcmpOutErrors
	ifInErrors	ipReasmOKs	IcmpOutDestUnreachs
	ifInUnknownProtos	ipReasmFails	IcmpOutTimeExcds
	ifOutOctets	ipFragOKs	IcmpOutParmProbs
	ifOutUcastPkts	ipFragFails	IcmpOutSrcQuenchs
	ifOutNUcastPkts	ipFragCreates	IcmpOutRedirects
	ifOutDiscards	ipAdEntAddr	IcmpOutEchos
	ifOutErrors	ipAdEntIfIndex	IcmpOutEchoReps
	ifOutQLen	ipAdEntNetMask	IcmpOutTimestamps
	ifSpecific	ipAdEntBcastAddr	IcmpOutTimestampReps
		ipAdEntReasmMaxSize	IcmpOutAddrMasks
		IpNetToMediaIfIndex	IcmpOutAddrMaskReps
		IpNetToMediaPhysAddress	
		IpNetToMediaNetAddress	
		IpNetToMediaType	
		IpRoutingDiscards	

UDP MIB	TCP MIB	SNMP MIB
UdpInDatagrams	tcpRtoAlgorithm	snmpInPkts
UdpNoPorts	tcpRtoMin	snmpOutPkts
UdpInErrors	tcpRtoMax	snmpInBadVersions
UdpOutDatagrams	tcpMaxConn	snmpInBadCommunityNames
UdpLocalAddress	tcpActiveOpens	snmpInASNParseErrs
UdpLocalPort	tcpPassiveOpens	snmpInTooBigs
	tcpAttempFails	snmpInNoSuchNames
Address Translation MIB	tcpEstabResets	snmpInBadValues
AtIfIndex	tcpCurrEstab	snmpInReadOnlys
AtPhysAddress	tcpInSegs	snmpInGenErrs
AtNetAddress	tcpOutSegs	snmpInTotalReqVars
	tcpRetransSegs	snmpInTotalSetVars
	tcpConnState	snmpInGetRequests
	tcpConnLocalAddress	snmpInGetNexts
	tcpConnLocalPort	snmpInSetRequests
	tcpConnRemAddress	snmpInGetResponses
	tcpConnRemPort	snmpInTraps
	tcpInErrs	snmpOutTooBigs
	tcpOutRsts	snmpOutNoSuchNames
		snmpOutBadValues
		snmpOutGenErrs
		snmpOutGetRequests
		snmpOutGetNexts
		snmpOutSetRequests
		snmpOutGetResponses
		snmpOutTraps
		snmpEnableAuthenTraps

D

Pin Assignments and Cable Wiring

In this appendix, common pin assignment and cable wiring diagrams are presented.

The following topics are covered in this appendix:

❑ **Pin Assignments**

- 10/100BaseTX Port Pin Assignment
- Console Port Pin Assignment
- Async RS-232 Port Pin Assignment

❑ **Cable Wiring**

- 10/100BaseTX Port Cable Wiring
- Async RS-232 Port Cable Wiring
- DB9 and DB25 Connector Pin Assignments

Pin Assignments

10/100BaseTX Port Pin Assignment

Pin	Signal
1	Tx+
2	Tx-
3	Rx+
6	Rx-

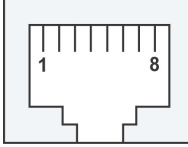

Console Port Pin Assignment

Pin	RS-232
1	DSR (in)
2	RTS (out)
3	GND
4	TxD (out)
5	RxD (in)
6	DCD (in)
7	CTS (in)
8	DTR (out)

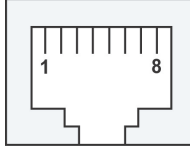

Async RS-232 Port Pin Assignment

Pin	RS-232
1	DSR (in)
2	RTS (out)
3	GND
4	TxD (out)
5	RxD (in)
6	DCD (in)
7	CTS (in)
8	DTR (out)

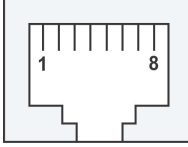

Cable Wiring

10/100BaseTX Port Cable Wiring

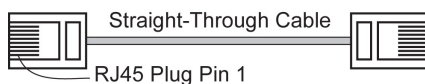

Cable Wiring

3	_____	3
6	_____	6
1	_____	1
2	_____	2



Cable Wiring

3	_____	1
6	_____	2
1	_____	3
2	_____	6

Async RS-232 Port Cable Wiring

8-pin RJ45 to Male DB9 for CN2510

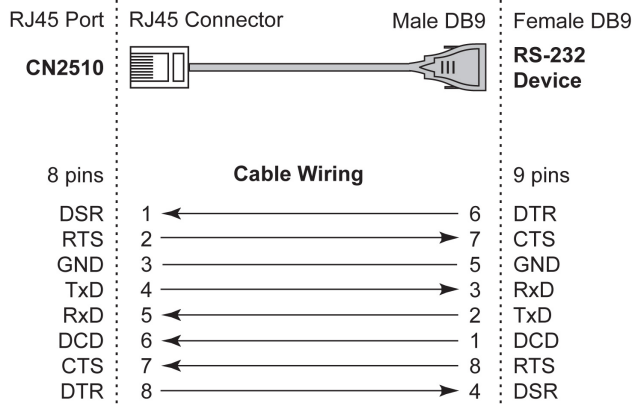

8-pin RJ45 to Female DB9 for CN2510

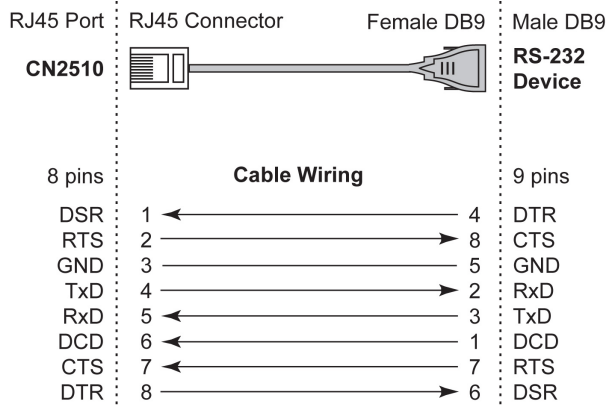

8-pin RJ45 to Female DB25 for CN2510

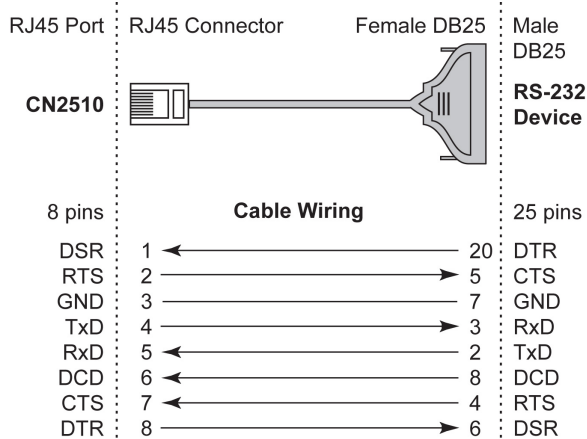

8-pin RJ45 to Male DB25 for CN2510

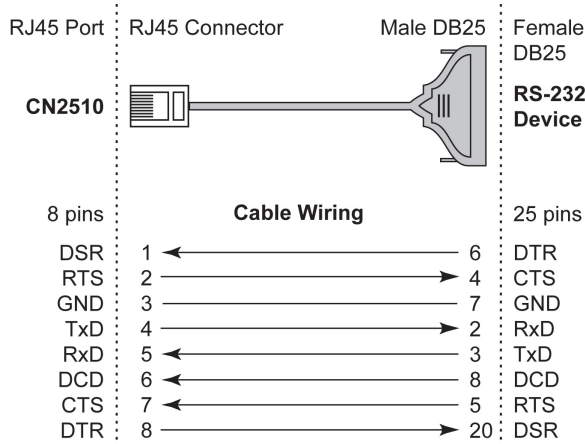

DB9 and DB25 Connector Pin Assignments

DB9 Connector Pin Assignment

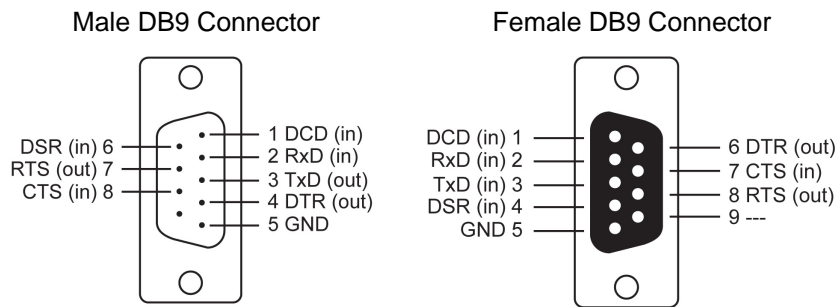

DB25 Connector Pin Assignment

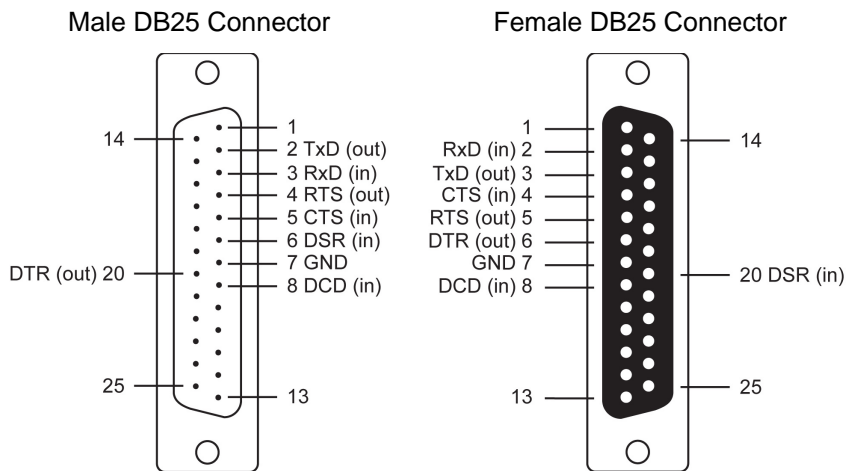

E

LCM Display

For first time installation, we recommend using the LCM display and four push buttons to configure the IP address.

Basic Operation

If the CN2510 is working properly, the LCM panel will display a green color. The red Ready LED will also light up, indicating that the CN2510 is receiving power. After the red Ready LED turns to green, you will see a display similar to:

C	N	2	5	1	0	-	8	_	1	9					
1	9	2	.	1	6	8	.	1	2	7	.	2	5	4	

This is where

- CN2510-8 is the CN2510's name
- 19 is the CN2510's serial number
- 192.168.127.254 is the CN2510's IP address

There are four push buttons on CN2510's nameplate. Going from left to right, the buttons are:

Button	Name	Action
MENU	menu	activates the main menu, or returns to an upper level
△	up cursor	scrolls up through a list of items shown on the LCM panel's 2nd line
▽	down cursor	scrolls down through a list of items shown on the LCM panel's 2nd line
SEL	select	selects the option listed on the LCM panel's 2nd line

The buttons are manipulated in a manner similar to the way a modern cellular phone operates. As you move through the various functions and setting options, note that the top line shows the current menu or submenu name, and the bottom line shows the submenu name or menu item which is activated by pressing the SEL button.

Detailed Menu Options

The best way to explain all of CN2510's LCM functions is to refer to the tree graph shown on the next page. There are three main levels—1, 2, and 3—with each level represented by a separate column.

The first thing to remember is that the MENU button is used to move back and forth between the LCM panel's default screen, and main menu screen:

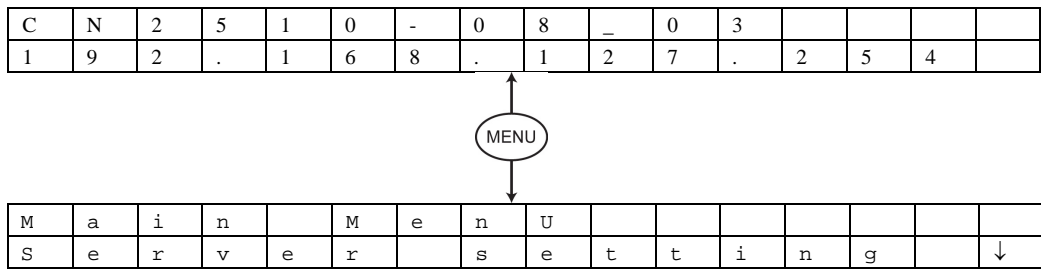

In addition, you only need to remember to:

- Use the SEL button to move up one level (i.e., left to right on the tree graph)
- Use the MENU button to move down one level (i.e., right to left on the tree graph)
- Use the cursor keys, Δ and ∇ , to scroll between the various options within a level (i.e., up and down on the tree graph).

As you use the buttons to operate the LCM display, you will notice that with very few exceptions, moving up one level causes the bottom line of the display to move to the top line of the display. You will also notice that the bottom three options in level 2, and all of the options in level 3 have either a C or D attached.

The meaning is as follows:

- C = configurable
I.e., you are allowed to change the setting of this option
- D = display only
I.e., the setting for this option is displayed, but it cannot be changed (this does NOT necessarily mean that the number doesn't change; only that you can't change it)

Main Menu			
	Server setting	Serial number Server name Firmware ver Model name	D C D D
	Network setting	Ethernet status MAC address IP config IP address Netmask Gateway DNS server 1 DNS server 2	D D C C C C C C C
	Serial set	Select port Baud rate Data bit Stop bit Parity	C C C C C

		Flow control	C
		Tx/Rx fifo	C
		Interface	C
		Tx/Rx bytes	D
		Line status	D

The part of the LCM operation that still requires some explanation is how to edit the configurable options. In fact, you will only encounter two types of configurable options. The first type involves entering numbers, such as IP addresses, Netmasks, etc. In this case, you change the number one digit at a time. The up cursor (Δ) is used to decrease the highlighted digit, the down cursor (∇) is used to increase the highlighted digit, and the sel button is used to move to the next digit. When the last digit has been changed, pressing sel simply enters the number into CN2510's memory.

The second type of configurable option is when there are only a small number of options from which to choose (although only one option will be visible at a time). Consider the Parity attribute under Serial set as an example. Follow the tree graph to arrive at the following Parity screen. The first option, None, is displayed, with a down arrow all the way to the right. This is an indication that there are other options from which to choose.

P	a	r	i	t	y														
N	o	n	e																↓

Press the down cursor button once to see Odd as the second option.

P	a	r	i	t	y														↑
O	d	d																	↓

Press the down cursor button again to see Even as the third option.

P	a	r	i	t	y														↑
E	v	e	n																↓

Press the down cursor button again to see Space as the fourth option.

P	a	r	i	t	y														↑
S	p	a	c	e															↓

Press the down cursor button yet again to see the last option, Mark.

P	a	r	i	t	y														↑
M	a	r	k																

To choose the desired option, press the SEL button when the option is showing on the screen.