

## USR-DR404 User Manual

File version: V1.0.1



# Contents

USR-DR404 User Manual.....	1
1. Product Overview.....	6
1.1. Brief Introduction.....	6
1.2. Specifications.....	6
2. Networking application.....	7
2.1. Wireless Networking Configuration.....	7
2.2. Wireless networking application.....	8
2.2.1. Wireless networking application(AP).....	8
2.2.2. STA Mode.....	9
2.2.3. AP+STA.....	10
2.2.4. Wireless Networking Applications (AP,STA).....	11
2.3. Wired Networking.....	12
2.4. Wired Networking Application.....	13
2.4.1. Wired Networking Application ( AP + LAN ) .....	13
2.4.2. Wired Networking Applications (AP+ WAN).....	14
2.4.3. Wired Networking Applications (Router).....	15
2.4.4. Wired Networking Applications (Bridge).....	17
3. Product function.....	18
3.1. Work mode.....	18
3.1.1. Transparent mode.....	19
3.1.2. Serial command mode.....	19
3.1.3. HTTPD Client Mode.....	20
3.1.4. Modbus TCP <=> modbus RTU.....	23
3.1.5. AT command mode.....	24
3.2. Socket.....	24
3.3. UART.....	25
3.3.1. Parameters.....	25
3.3.2. UART Free framing.....	26
3.3.3. UART auto-framing mode.....	27
3.4. Synchronous Band Rate (RFC2217).....	28
3.5. RFC2217 Protocol Description.....	28
3.6. USR-Link.....	29
3.7. USR Cloud.....	31
3.8. Heartbeat Packet Function.....	31
3.9. Socket Distribution.....	32
3.10. Timeout Restart.....	34
3.11. Timing Restart.....	35
3.12. Modbus Polling.....	35
3.13. Remote Upgrade.....	36
3.13.1 Serial server configuration.....	36
3.13.2 Remote upgrade system configuration.....	37
3.14. Websocket.....	40

---

4. Product parameter setting.....	41
4.1. Web Page.....	41
4.1.1. Open the Management Webpage.....	42
4.1.2. Quick Configure.....	42
4.1.3. Mode Selection.....	43
4.1.4. AP Interface Setting.....	44
4.1.5. STA Interface Setting.....	45
4.1.6. Application setting.....	45
4.1.7. Ethernet setting.....	48
4.1.8. HTTPD Client Mode.....	49
4.1.9. Advanced.....	50
4.1.10. Device Management.....	52
4.2. AT command.....	53
4.2.1. Serial AT Command.....	53
4.2.2. Net AT command.....	55
4.3.3 Command Format.....	56
4.3.4 AT command.....	57
4.3.4.1. AT+E.....	59
4.3.4.2. AT+ENTM.....	59
4.3.4.3. AT+NETP.....	60
4.3.4.4. AT+UART.....	60
4.3.4.5. AT+UARTF.....	61
4.3.4.6. AT+UARTFT.....	61
4.3.4.7. AT+UARTFL.....	62
4.3.4.8. AT+TMODE.....	62
4.3.4.9. AT+WMODE.....	62
4.3.4.10. AT+WSKEY.....	63
4.3.4.11. AT+WSSSID.....	64
4.3.4.12. AT+WSLK.....	64
4.3.4.13. AT+WEBU.....	64
4.3.4.14. AT+WAP.....	65
4.3.4.15. AT+WAKEY.....	65
4.3.4.16. AT+MSLP.....	66
4.3.4.17. AT+WSCAN.....	66
4.3.4.18. AT+TCPLK.....	67
4.3.4.19. AT+TCPDIS.....	67
4.3.4.20. AT+WANN.....	68
4.3.4.21. AT+LANN.....	68
4.3.4.22. AT+TCPTO.....	68
4.3.4.23. AT+MAXSK.....	69
4.3.4.24. AT+TCPB.....	69
4.3.4.25. AT+TCPPTB.....	70
4.3.4.26. AT+TCPADDB.....	70
4.3.4.27. AT+TCPTOB.....	70

---

4.3.4.28. AT+TCPLKB.....	71
4.3.4.29. AT+EPHY.....	71
4.3.4.30. AT+FUDLX.....	71
4.3.4.31. AT+AABR.....	72
4.3.4.32. AT+DHCPDEN.....	72
4.3.4.33. AT+HIDESSID.....	72
4.3.4.34. AT+DOMAIN.....	72
4.3.4.35. AT+RELD.....	73
4.3.4.36. AT+Z.....	73
4.3.4.37. AT+MID.....	73
4.3.4.38. AT+VER.....	73
4.3.4.39. AT+H.....	74
4.3.4.40. AT+WSQY.....	74
4.3.4.41. AT+HTPMODE.....	74
4.3.4.42. AT+HTTTPURL.....	75
4.3.4.43. AT+HTTPTP.....	75
4.3.4.44. AT+HTTTPH.....	75
4.3.4.45. AT+HTTPCN.....	76
4.3.4.46. AT+HTTTPUA.....	76
4.3.4.47. AT+HTPSV.....	76
4.3.4.48. AT+HTPTP.....	77
4.3.4.49. AT+HTPURL.....	77
4.3.4.50. AT+HTPHEAD.....	77
4.3.4.51. AT+REGEN.....	78
4.3.4.52. AT+REGTCP.....	78
4.3.4.53. AT+WTPWR.....	79
4.3.4.54. AT+REGCLOUD.....	79
4.3.4.55. AT+REGUSR.....	79
4.3.4.56. AT+TCPDPEN.....	80
4.3.4.57. AT+HEARTEN.....	80
4.3.4.58. AT+HEARTTP.....	80
4.3.4.59. AT+HEARTDT.....	81
4.3.4.60. AT+HEARTTM.....	81
4.3.4.61. AT+REBOOTEN.....	81
4.3.4.62. AT+REBOOTT.....	82
4.3.4.63. AT+TIMEOUTEN.....	82
4.3.4.64. AT+TIMEOUTT.....	83
4.3.4.65. AT+FAPSTA.....	83
4.3.4.66. AT+HTTTPSCEN.....	83
4.3.4.67. AT+MODBPOLLEN.....	84
4.3.4.68. AT+UPDATE.....	84
4.3.4.69. AT+MONITOR.....	85
5. Contact us.....	85
6. Disclaimer.....	85

---

## Features

- Support 802.11b/g/n wireless standards.
- Support usr-link.
- Support route and bridge modes.
- Support RS485 to Wifi/ Ethernet communication.
- Rich indicator LED: Power, link, RXD, TXD.
- Wide voltage DC 5~36V, support terminal power.
- Support transparent transmission mode, serial command mode, HTTPD Client (GET, PUT and POST), MODBUS, AT command mode.
- Support three types of registration packets: MAC, USR-Cloud, custom.
- Support custom heartbeat packet, distributing socket protocol, MODBUS polling function
- Support timeout reset function, timing reset function.
- Support remote upgrade.
- Add hardware watch dog, makes more stable
- Supports free framing and automatic framing on the serial port, for higher forwarding efficiency.
- Support websocket and realize the timing communication for serial port and web page.
- Support web page, serial/network AT command to configure parameters.
- Support one key (press the reload button for more than 5 seconds) to restore factory settings.
- Long distance communication: two serial server can transport for 150m(Test conditions: open line of sight, two WIFI serial servers self-networking, 57600 baud rate, no packet loss during transmission).
- Designed with guide rails for easy installation.

# 1. Product Overview

## 1.1. Brief Introduction

USR-DR404 supports serial port to WIFI function, make the serial port (RS485)connection switch into TCP/IP net interface to realize the bi-direction transparent transmission between serial port and WIFI/Ethernet. Enable serial devices to have TCP / IP network interface function immediately, connect to the network for data communication, greatly extend the communication distance of serial devices, as below:

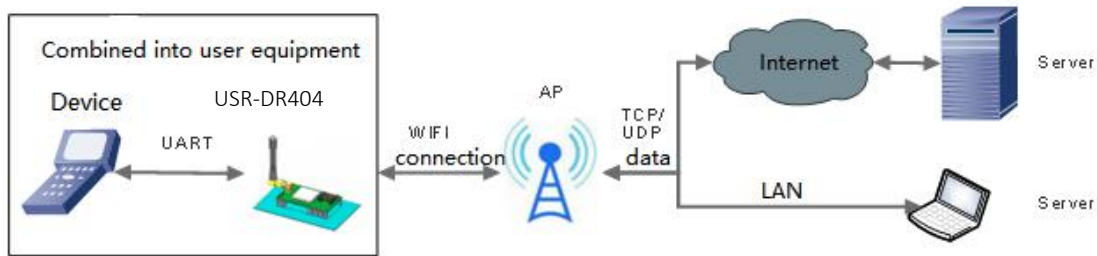

Diagram 1 Basic function

## 1.2. Specifications

	Item	Description	
Wireless parameters	Standard certification	FCC/CE	
	Wireless standard	802.11 b/g/n	
	Frequency range	2.412GHz-2.484GHz	
	Transmitting power	802.11b:	+19dBm(Max.@11Mbps)
		802.11g:	+18dBm(Max.@54Mbps)
		802.11n:	+17dBm(Max.@HT20,MCS7) +17dBm(Max.@HT40,MCS7)
		User can configure power	
Receive sensitivity	802.11b:	-89dBm(@11Mbps)	
	802.11g:	-81dBm(@54Mbps)	
	802.11n:	-73dBm(@HT20,MCS7) -71dBm(@HT40,MCS7)	
Hardware parameters	Data interface	RS485: 300~230.4Kbps	
		485 interface (anti surge, anti thunder, overcurrent protection)	
		Ethernet: 10Mbps/100Mbps	

	Run voltage	DC5~36V
	Run temp	-40℃~ 85℃
	Storage temp	-40℃~ 125℃
	Size	109.66*28*64.71mm(L*W*H)
Software parameters	Wireless network type	Station/AP/AP+Station mode
	Safety	WPA-PSK/WPA2-PSK
	Encryption type	TKIP/AES
	Run mode	Transparent transmission mode, Protocol transmission mode
	Setting command	AT+ command
	Net protocol	TCP/UDP/ARP/ICMP/DHCP/DNS/HTTP
	Max number of connected TCP	24
	User configure	Web server +AT command configure
	Custom application software	Support custom customize application software

Form 1 Parameters

## 2. Networking application

USR-DR404 supports wireless WIFI and wired Ethernet communication modes, flexible networking and network topology.

### 2.1. Wireless Networking Configuration

USR-DR404 can configure to be a STA or an AP. Can be set by AT command, web page, as below:

(1) AT command setting: Set by AT + WMODE, it can be set to AP or STA.

Example: Set the WIFI serial server to STA mode. After entering the AT command mode, send the following command:

Set WIFI serial server to STA mode

```
AT+WMODE=STA
```

Restart

```
AT+Z
```

After restarting, the serial server will work in STA mode.

(2) Web page settings are as follows:

For example, log in to the built-in web page of the serial server, enter the mode selection page, and select Station mode (set the WIFI serial server to STA mode), as follows:

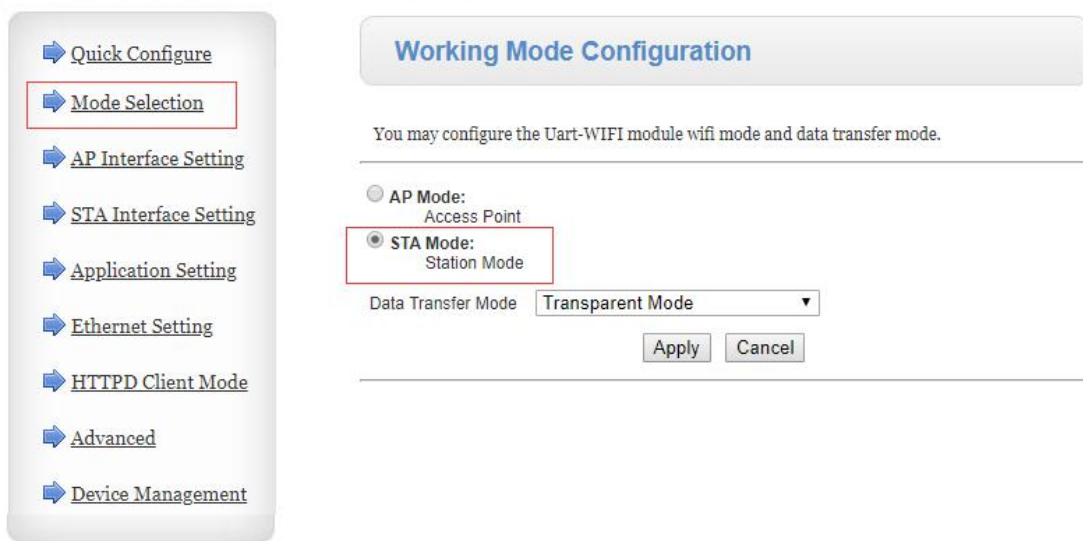

**Diagram 2 Set WiFi mode in web page**

Click "Apply", enter "Device Management" interface, restart.

AP+STA function, can be set by AT command or customized as the factory default.

## 2.2. Wireless networking application

### 2.2.1. Wireless networking application(AP)

WiFi can do as a AP, other serial port device and PC as a STA can connect the WiFi, also it can be connected to user device via RS485, as follows:

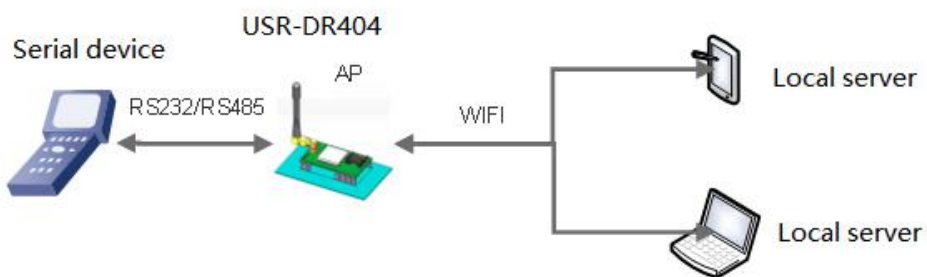

**Diagram 3 AP mode**

The WiFi serial server works in AP mode. The above applications can be set using the following AT commands:

(1) Set the WiFi server to AP mode

AT+WMODE=AP



(2) The parameters of the WIFI serial server in AP mode can be set according to needs or use the default parameters. For example:

```
AT+WAP=11BGN,USR-DR404-TEST,Auto(Optional)
```

```
AT+WKEY=WPA2PSK,AES,12345678(Optional)
```

(3) Restart

```
AT+Z
```

Note:

1. All AT command settings need to enter the AT command mode (for details, please refer to the section “4.3.1. Serial AT Commands” )

2. After restarting the device, the parameter settings take effect. To refresh the original configuration information in memory and restart the operation.

## 2.2.2. STA Mode

USR-DR404 do as STA and connect to other APs to form a wireless network, all STA take the AP as wireless networking centre, mutual communication between STAs is completed through AP forwarding, as below:

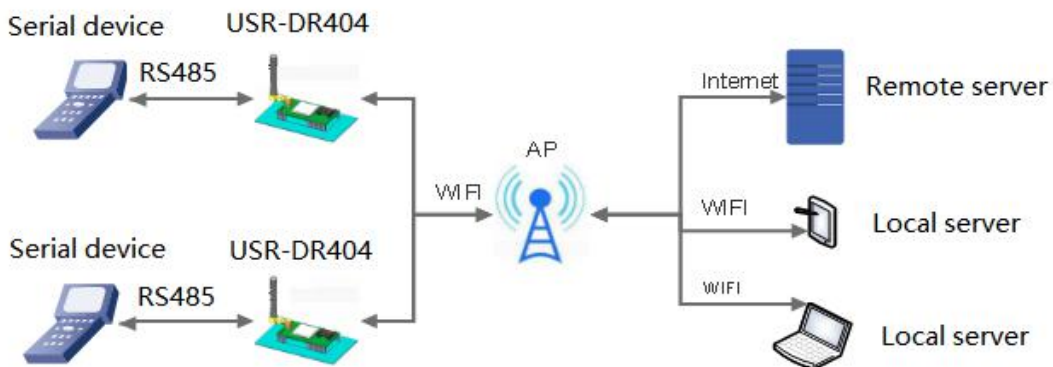

**Diagram 4 STA mode**

WIFI serial server parameter settings are as follows:

(1) Set the working mode of WIFI serial server:

```
AT+WMODE=STA
```

(2) Set the SSID, encryption mode, and password of the router to be connected (for example, the SSID of the route is: USR-WIFI-TEST, the encryption mode is WPA2PSK, AES, and the password is www.usr.cn). As follows:

```
AT+WSSID=USR-WIFI-TEST
```

```
AT+WKEY=WPA2PSK,AES,www.usr.cn
```

(3) Restart

```
AT+Z
```

### 2.2.3. AP+STA

USR-DR404 can support one AP and one STA meanwhile. Enable the AP+STA function, STA and AP interface can be used meanwhile, STA interface connected to the router, and then connected to the server in the internet via TCPB; AP interface can be connected by the phone/ pad (TCPA). So the TCP server, phone /pad can control the device connected to the DR404 and configure the parameters for the DR404. As below:

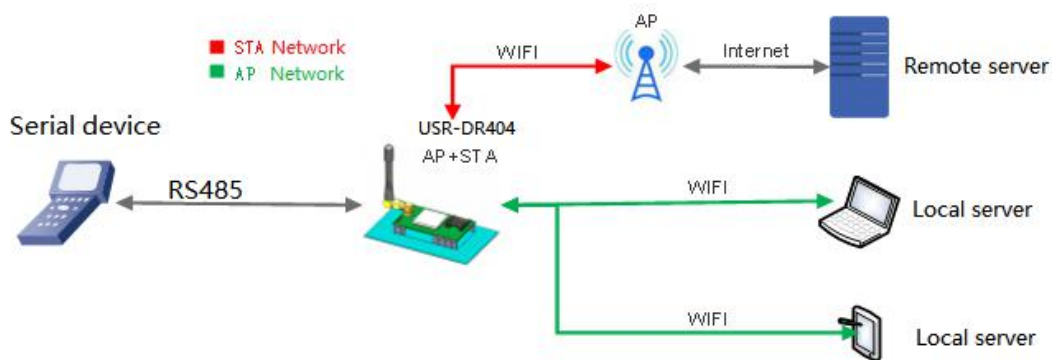

Diagram 5 AP+ STA mode

WIFI serial server parameter settings are as follows:

- (1) Enable AP + STA function of WIFI serial server

AT+FAPSTA=on

- (2) Parameters take effect after resetting the module

AT+RELD

- (3) Set the WIFI serial server to STA mode, the WIFI serial server AP interface is still valid

AT+WMODE=STA

- (4) Set the SSID, encryption mode, and password of the route to be connected (for example, the SSID of the route is: USR-WIFI-TEST, the encryption mode id WPA2PSK, AES, and the password is [www.usr.cn](http://www.usr.cn)). As follows:

AT+WSSSID=USR-WIFI-TEST

AT+WSKEY=WPA2PSK,AES,www.usr.cn

- (5) Set socket A, socket B

Socket A setting example:

AT+NETP=TCP,Server,8899,10.10.100.100

Set the IP and port of the server to be connected.

Socket B setting example:

AT+TCPADDB=192.168.1.100

AT+TCPPTB=18899

- (6) Restart

AT+Z

**Note:**

When the AP + STA function is enabled, the STA port needs to be connected to another router. Otherwise, the STA port will continuously scan the router, which will affect the AP port during scanning, such as data loss. If the user determines that the STA cannot connect to the AP at this time, you can use the command to stop the scanning of the STA port:

```
AT+STTC=on/off
```

“on” means to scan the router, “off” means not to scan, this command will not save after restart.

```
AT+FSTTC=on/off
```

This command can be saved, takes affect after restart.

**Web page settings:** Login to built-in web pages, enter “STA Interface Setting”, enable AP+STA function.

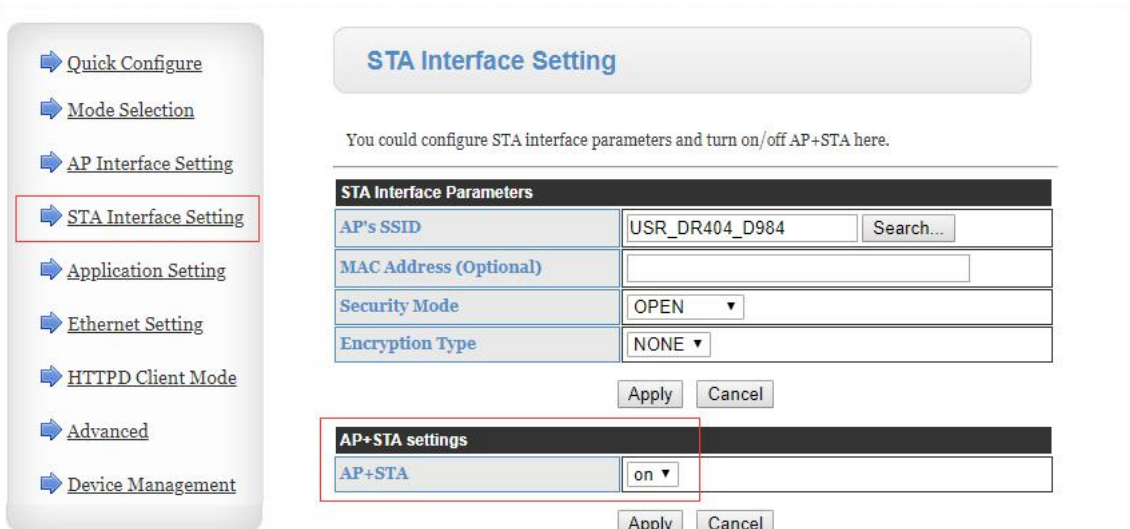

After clicking “Apply”,restart to take affect.

### 2.2.4. Wireless Networking Applications (AP,STA)

USR-DR404 can be configured to be a STA and a AP , in theory support 2 wireless interface, one STA and one AP, other STA will connected to the network via this AP.

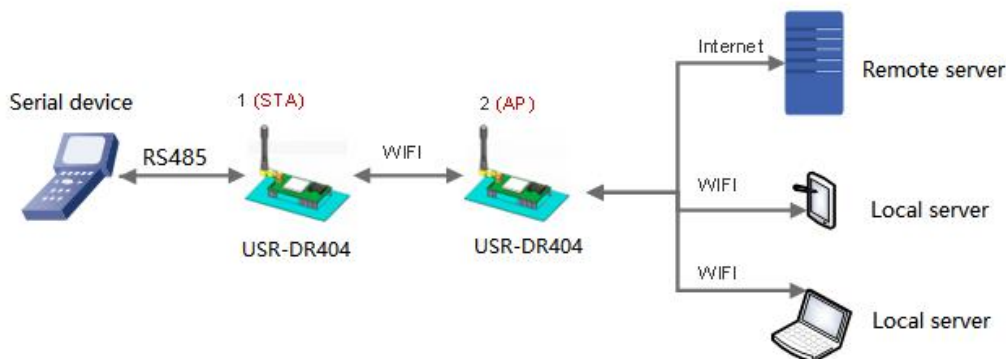

Diagram 6 Wireless Networking Application

WIFI serial server parameter settings are as follows:

The WIFI serial server numbered 1 works in STA mode, and the numbered 2 works in AP mode:

(1) For No. 1 WIFI serial server, set to STA

AT+WMODE=STA

(2) For No. 2 WIFI serial server, set to AP

AT+WMODE=AP

(3) The WIFI serial server No. 1 is connected to the AP (WIFI serial server 2) as a STA. Therefore, the SSID and password to be connected to WIFI serial server 1 are the AP parameters of WIFI serial server 2.

The SSID and password of the No. 2 WIFI serial server can be queried by the following AT command:

AT+WAP

AT+WKEY

Can also be set as required, or use the default parameters. The example of parameters setting of WIFI serial server 2 are as follows:

AT+WAP=11BGN,USR-DR404-TEST,Auto(Optional)

AT+WKEY=WPA2PSK,AES,12345678(Optional)

An example of parameter setting of No. 1 WIFI serial server is as follows (the AP parameters to be connected correspond to the SSID and password of WIFI serial server 2):

AT+WSSSID=USR-DR404-TEST

AT+WKEY=WPA2PSK,AES,12345678

Consistent with WIFI serial server 2 parameters.

(4) Restart

AT+Z

## 2.3. Wired Networking

Related AT command:

	Item	Description
1	WMODE	Setting/query WIFI operating mode(AP、STA)
2	WSSSID	Setting/query related AP SSID
3	WKEY	Setting/query encryption under the WIFI STA mode
4	WANN	Setting/query net parameters of the STA
5	WCLK	Query the wireless connection status of the STA
6	WAP	Setting/query the parameters under the WIFI AP mode
7	WKEY	Setting/query encryption parameters under the WIFI AP mode
8	LANN	Setting/query the IP under the AP mode
9	FEPHY	Enable/disable Ethernet interface
10	FVER	Setting/query module software version (N-Ver、Z-Ver)

Form 2 Related AT Command

	Item	Description
--	------	-------------

1	NETP	Setting/query the net protocol parameters of the TCPA
2	TCPB	Enable/disable TCPB
3	TCPPTB	Setting/query the port of the TCPB
4	TCPADDB	Setting/query the server of the TCPB

**Form 3 Socket Related AT Command**

Webpage configure are as follows:

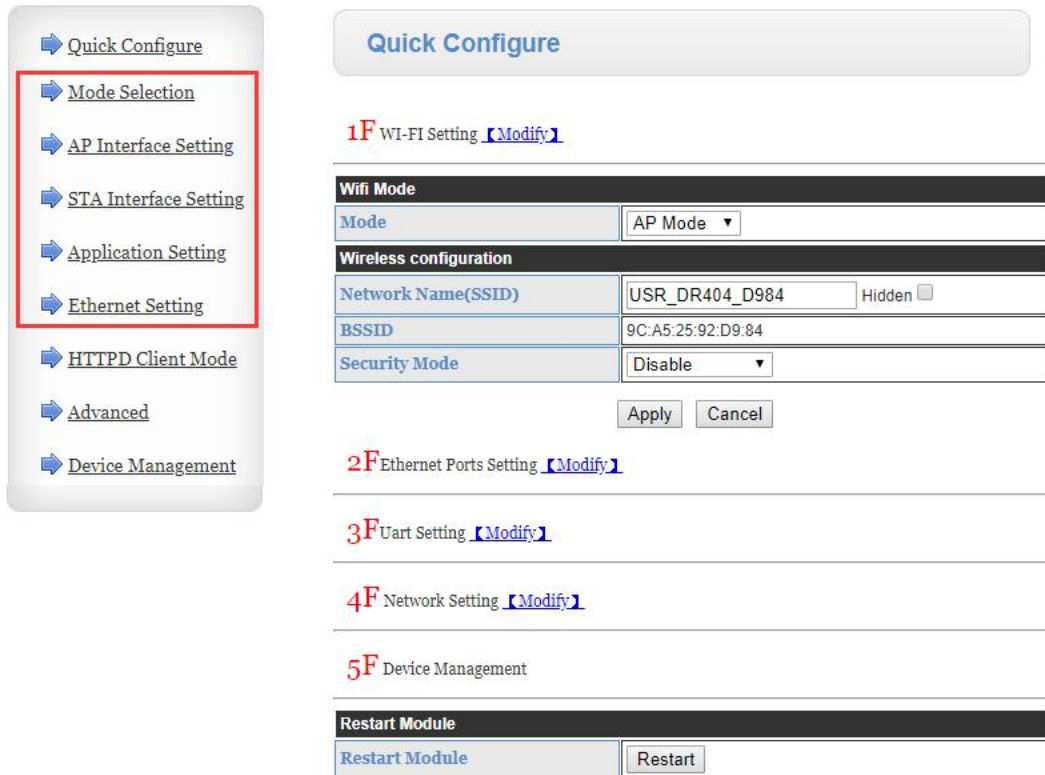
**Diagram 7 Ethernet interface networking setting webpage**

The USR-DR404 serial server provides a 100M Ethernet interface. Through this 100M Ethernet interface, users can realize the interconnection of the three interfaces of WIFI, serial port and Ethernet port. In terms of networking, the USR-DR404 serial server network port can be set to LAN port and WAN port; at the same time, it supports bridge mode and routing mode to correspond to different specific applications.

## 2.4. Wired Networking Application

### 2.4.1. Wired Networking Application (AP + LAN)

When USR-DR404 works in AP mode, other STA devices can connect to this WIFI serial server through RJ 45 or WIFI. In this networking, all device will be distributed a IP in same network segment with USR-DR404. Application diagram as follow:

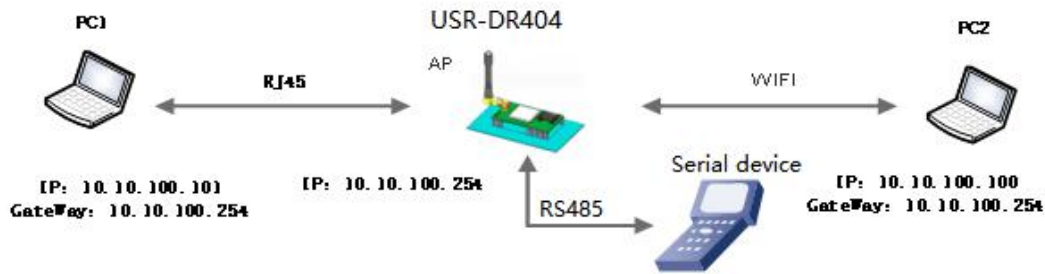

Diagram 8 AP+LAN Application

WIFI serial server parameter settings:

- (1) Enable Ethernet interface

AT+FEPHY=on

- (2) The above settings will take effect after restoring factory settings

AT+RELD

AT + RELD command does not restore the above settings.

- (3) Set USR-DR404 to AP

AT+WMODE=AP

- (4) For the LAN parameters of the serial server, can use the default parameters or modify the IP address (DHCP gateway) and subnet mask of the serial server. Here are the default parameters:

AT+LANN=10.10.100.254,255.255.255.0

- (5) Restart

## 2.4.2. Wired Networking Applications (AP+ WAN)

USR-DR404 works in AP mode, set the Ethernet interface to WAN, connected to the router that can search the internet, and enable the DHCP. Now USR-DR404 works as a second grade router, PC and pad connect to the AP(USR-DR404) can be online, the default AP is USR-DR404\_xxxx, no encryption, 000000000000 which can be setting by web page or AT command.

After the DR404 connects to the AP and get IP address from AP(192.168.1.1). The DR404 can form a subnet(default 10.10.100.254). The device on the Ethernet interface is assigned an address by the serial server, such as 10.10.100.100 in the below diagram:

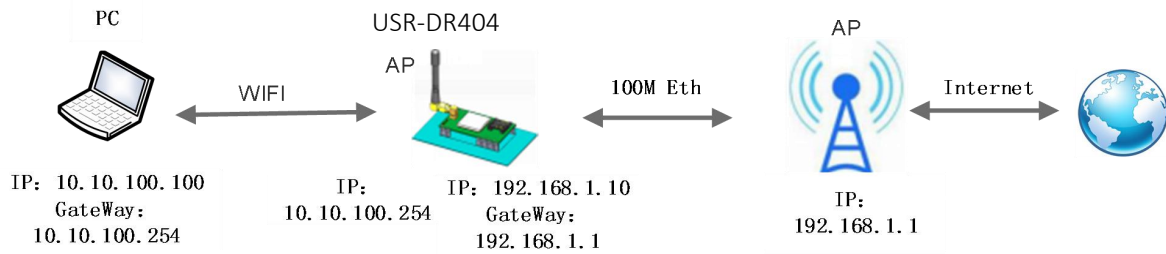
**Diagram 9 AP+WAN Application**

WiFi serial server parameter settings:

(1) Enable Ethernet interface

AT+FEPHY=on

(2) Set the working mode of Ethernet to WAN

AT+FVEW=enable

(3) The above settings will take effect after restoring factory settings

AT+RELD

AT + RELD command does not restore the above settings.

(4) DR404 works in AP mode, enable DHCP(Default)

AT+WMODE=ap

AT+DHCPDEN=on

(5) For security reasons, can modify the AP name and encryption parameters (optional)

AT+WAP=11BGN,B2-WIFI-TEST,Auto

AT+WKEY=WPA2PSK,AES,www.usr.cn

(6) Can keep the default or set LAN parameters of serial server, IP address (DHCP gateway) and subnet mask (optional)

AT+LANN=192.168.2.1,255.255.255.0

Note: It is necessary to ensure that the LAN IP address set cannot be on the same network segment as the WAN IP address obtained by the serial server from the AP!

(7) Restart

### 2.4.3. Wired Networking Applications (Router)

DR404 works as a STA, in router mode (software is N-Ver). Connected to the AP and obtained an IP address from the AP such as 192.168.1.101 in the below diagram. DR404 forms a subnet (default 10.10.100.254) which distributes the IP address to the devices that connect to its Ethernet interface. As below, PC1 in the subnet, for DR404 works in router mode, PC1 can be connected to the PC2, but PC2 can not be connected to PC1.

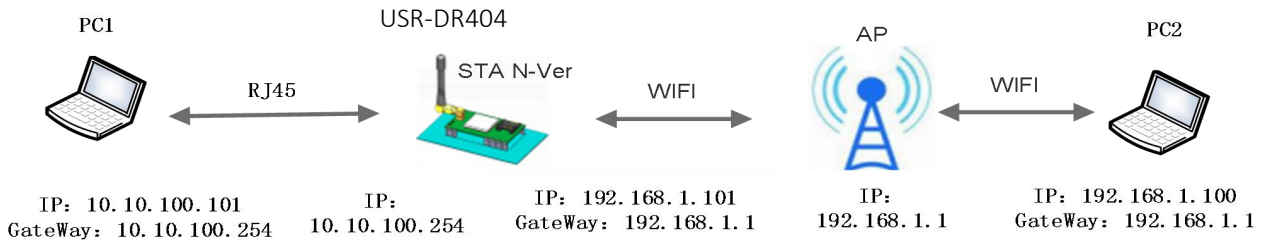

**Diagram 10 Router Application**

WIFI serial server parameter settings:

- (1) Set the serial server software version to N-Ver

AT+FVER=n

- (2) Enable Ethernet interface

AT+FEPHY=on

- (3) Reset the module, the setting will take affect

AT+RELD

AT + RELD command does not restore the above settings.

- (4) Set the working mode to STA

AT+WMODE=STA

- (5) Set the SSID and password of the route to be connected (according to the actual parameters of the route)

For example: AT+WSSSID=USR-WIFI-TEST

AT+WSKEY=WPA2PSK,AES,www.usr.cn

- (6) Set LAN parameters of serial server, IP address (DHCP gateway) and subnet mask

Query the IP obtained by the serial server from the AP:

AT+WANN

Set the LAN parameters of the serial server to ensure that the LAN IP address cannot be on the same network segment as the WAN IP address obtained by the serial server from the AP. Since this example is not on a network segment, can keep the default:

AT+LANN=10.10.100.254,255.255.255.0(Optional)

- (7) Restart.

Web page setting: Log in to the built-in web page of DR404, enter the page of Ethernet setting, and set the Ethernet Mode to "n" in the Ethernet mode settings.

As shown below:



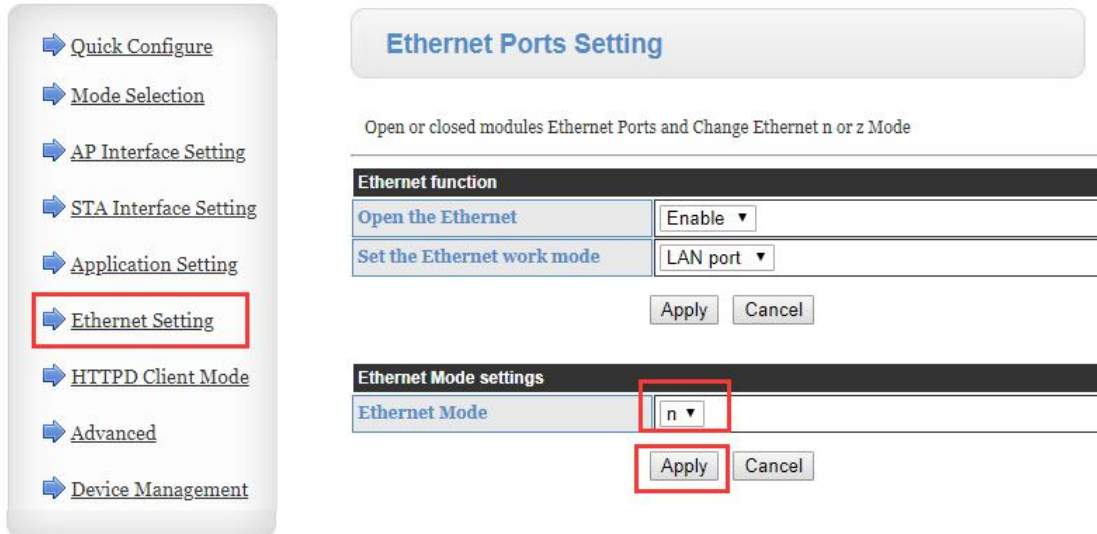

Diagram 11 Ethernet port

Click “Apply”, then restart the module to take affect.

### 2.4.4. Wired Networking Applications (Bridge)

DR404 works as a STA , and works in bridge mode(software is Z-Ver). After connecting to AP, device connected to the Ethernet interface will get an IP address from AP such as 192.168.1.101 in below diagram. In the whole network, DR404 works as a transparent device, PC1 and PC2 can communicate to each other without any limited. But if you want to realize the communication between the DR404 and other devices, you need to set a static LAN IP address such as 192.168.1.10.

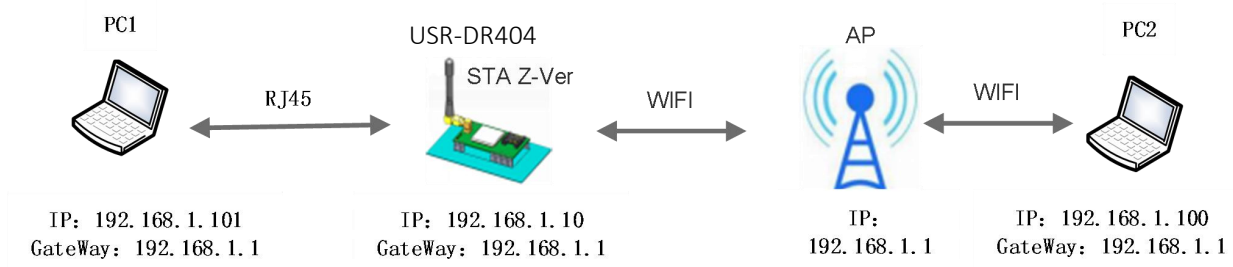

Diagram 12 Bridge Application

WIFI serial server parameter settings:

- (1) Set the serial server software version to Z-Ver  
AT+FVER=z
- (2) Enable Ethernet interface  
AT+FEPHY=on
- (3) Reset the module, the setting will take affect  
AT+RELD  
AT + RELD command does not restore the above settings.
- (4) Set the working mode to STA  
AT+WMODE=STA

- (5) Set the SSID and password of the route to be connected  
For example: AT+WSSSID=USR-WIFI-TEST  
AT+WSKEY=WPA2PSK,AES,www.usr.cn
- (6) Set LAN parameters of serial server, IP address (DHCP gateway) and subnet mask  
AT+LANN=192.168.1.10,,255.255.255.0
- (7) Restart.

Web page setting: Log in to the built-in web page of DR404, enter the page of Ethernet setting, and set the Ethernet Mode to "z" in the Ethernet mode settings.

As shown below:

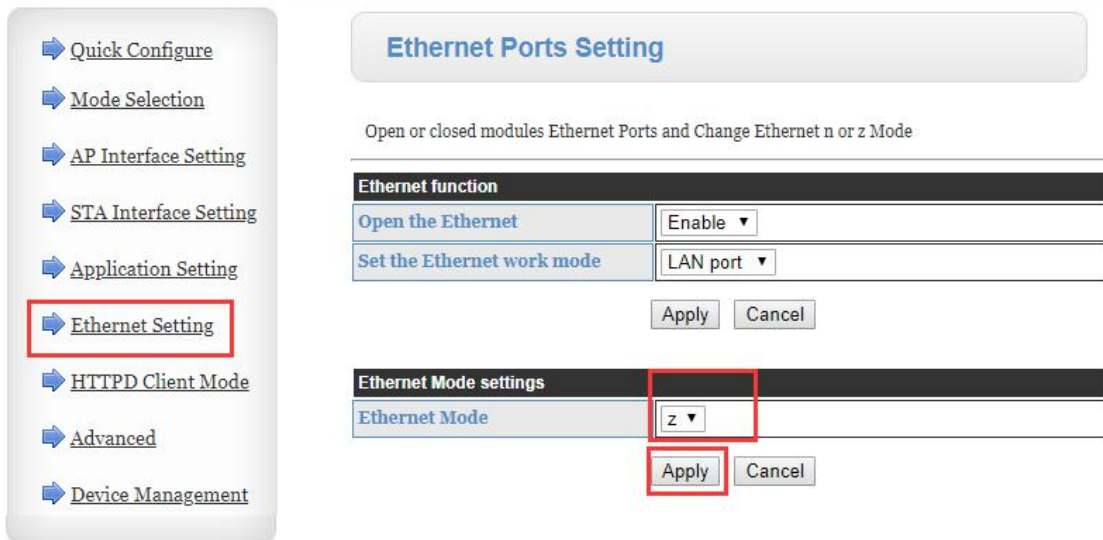

Diagram 13 Ethernet Mode Setting

Click "Apply", then restart the module to take affect.

### 3. Product function

#### 3.1. Work mode

USR-DR404 serial server has five working modes: transparent mode, serial command mode, HTTPD Client mode, Modbus TCP <=> Modbus RTU mode, AT command mode. Except for the AT command mode, the switching between the other modes can be set through the USR-DR404 built-in web page (please refer to the relevant section of "Mode Selection" in this manual) or the AT command (please refer to the "AT + TMODE" section);

The first three modes can send "+++" and "a" successively through the serial port. USR-DR404 will return the confirmation codes "a" and "+ok" in order to switch to the AT command mode. AT + ENTM can return USR-DR404 from AT command mode to the original working mode. For details, please refer to the related chapter of "Serial AT Command".

### 3.1.1. Transparent mode

USR-DR404 supports transparent transmission mode. Under this mode, the data needs to be sent and received will be transported transparently between the serial port and WIFI/Ethernet, no analyzing, minimize the complexity of use.

### 3.1.2. Serial command mode

In this mode ,when USR-DR404 works in UDP client or TCP client, allow sending serial data to different servers.

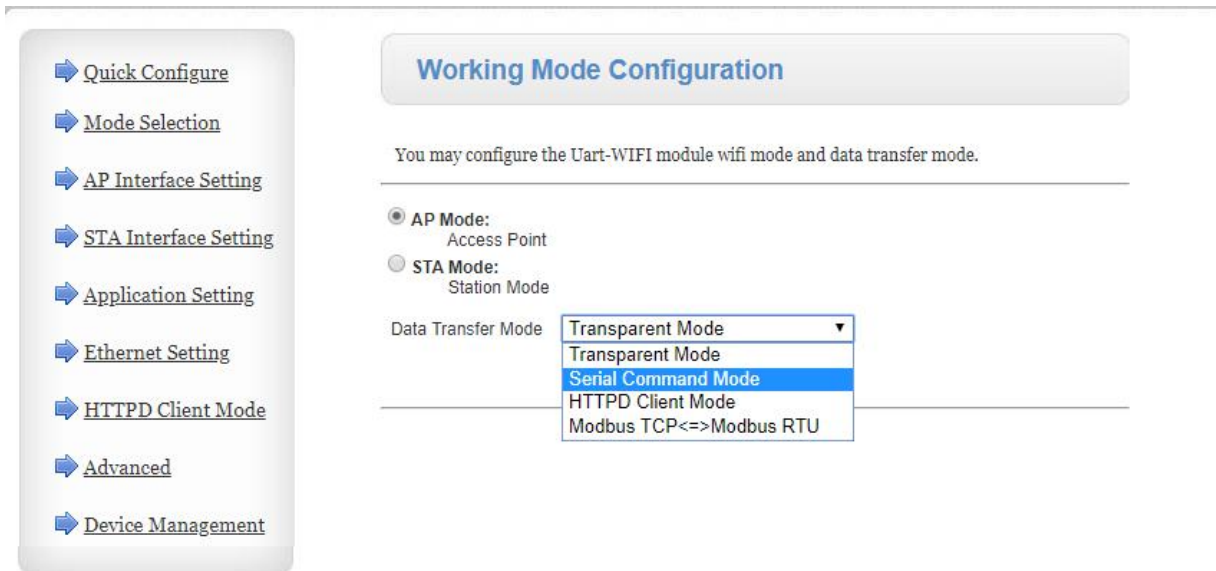

Diagram 14 Serial command mode

The MCU sends data packets according to the following format. After the WIFI serial server has finished parsing, it only sends n bytes of data to the destination address. When data is returned, the data is output directly from the serial port without parsing.

Header	Length	Function code	Reserved parameter	Destination port	Destination address	Data	Parity
2	2 (n+m+5)	1	2	2	m	n	1

Form 4 Serial command mode

**Header:**

0x55 0xaa

**Length:**

The total number of bytes from function code(included) to parity (do not included), the high is in front.

**Function code:**

Bit0: ( UDP: 0 ; TCP: 1 )

Bit1: ( long connection: 0 ) Note: Only long connections are currently supported.

Bit2: ( IP: 0; domain name: 1 )

Bit7: (Simple protocol: 0; Full protocol: 1) Note: Only simple protocols are currently supported.

Note:

- For Bit1, long connection, then after sending data, the connection will remain until the target address is changed again.
- For Bit2, it indicates whether the destination address is IP or domain name. If it is IP, the destination address is 4 bytes; if it is a domain name, the length of the destination address is the length of the entire domain name string (where the last byte of the destination address is 0x00, is the end of the string, the length of the domain name is indefinite)
- For Bit7, under the simple protocol, the reply frame contains only data; under the full protocol, the reply frame will fail to send, waiting for timeout, and the frame format of the response device IP under UDP broadcast.

**Reserved parameter:**

First byte: long connection, 0x00.

Second byte: reserved.

**Destination port:**

Low byte first, such as port 33, here is 21 00.

**Destination address:**

If it is IP, it is 4 bytes. For example, 192.168.0.133 means 85 00 A8 C0; if it is a domain name, the address length is indefinite and ends with "\ 0".

**Data:**

Variable length, up to 1000 bytes

**Parity:**

From the function code, to the byte before the parity, add. The following are examples of specific applications:

Send data: 55 aa 00 0a 00 00 00 21 00 85 00 A8 C0 01 0f

Length type 00 0a: Length: n+m+5, here is 10

Function code 00: UDP mode

Destination IPaddress 85 00 A8 C0: 192.168.0.133

Data 00: Length is 1,

Parity: 0x00+0x00+0x00+0x21+0x00+0x85+0x00+0xA8+0xC0+0x01=0x0f

### 3.1.3. HTTPD Client Mode

The HTTPD Client mode supports three HTTP request methods: POST, PUT, and GET. After setting the specific content of the HTTP header through the AT command or the web page, each time data is sent, the WIFI serial server will automatically encapsulate the sent data into HTTP protocol data and send it to the designated HTTP server. The data received from the server will be directly transmitted to the serial port without any processing.

The following are specific application examples:

First set HTTP parameters through AT command:

No.	Item	Description
-----	------	-------------

1	HTPMODE	New and old, HTTP header setting mode switch(HTTPD Client)
2	HTTTPURL	Old setting/query HTTP server IP and port
3	HTTTPTP	Old setting/query HTTP requesting type
4	HTTTPPH	Old setting/query HTTP protocol header path
5	HTTTPCN	Old setting/query HTTP protocol header Connection
6	HTTTPUA	Old setting/query HTTP protocol header User-Agent
7	HTPSV	New setting/query server address and IP(HTTPD Client)
8	HTPPTP	New setting/query requesting way(HTTPD Client)
9	HTPURL	New setting/query requesting path(HTTPD Client)
10	HTPHEAD	New setting/query HTTP header(HTTPD Client)
11	HTTTPSCEN	Setting/query HTTPD Client connection mode(long/short)
12	HTTTPSCT	Setting/query HTTPD Client short connection timeout(3-65535s)

**Form 5 Related AT Command**

If the data sent is 1234, then you will receive the following data on port 80 of test.usr.cn.

```
POST /2.php? HTTP /1.1
Connection:keep-alive
User-Agent:lwip1.3.2
Content-Length:4
Host:test.usr.cn:80
```

1234

If the HTTP type is GET, the data received on port 80 of test.usr.cn is

```
GET /1.php? data= 1234 HTTP /1.1
Connection:keep-alive
User-Agent:lwip1.3.2
Host:test.usr.cn:80
```

When the request method is POST or PUT, the data of the serial port will be added after the HTTP protocol header; when the request method is GET, the data of the serial port will be added after the protocol header path.

Users can customize the content of the HTTP header in the new version of the definition method, and can add, delete, and modify the content of each HTTP header according to their own needs(If the HTTP request type is POST / PUT, USR-DR404 will automatically add Content-Length).The setting commands include "AT + HTPMODE, AT + HTPSV, AT + HTPPTP, AT + HTPURL, AT + HTPHEAD". For specific command setting procedures, please refer to the "AT command" chapter. Similarly, there are corresponding settings pages in the web page.

Note: The above definition method is called the old definition method. In the new version of the setting method, a new HTTP header definition method is added. If you use the AT command to set the HTTP header, please use "<< CRLF >>" instead of carriage return and line feed. There is no need to consider carriage return when setting the built-in web page. The web page settings are as follows:

- (1) Set HTTPD request type:

- ➔ [Quick Configure](#)
- ➔ [Mode Selection](#)
- ➔ [AP Interface Setting](#)
- ➔ [STA Interface Setting](#)
- ➔ [Application Setting](#)
- ➔ [Ethernet Setting](#)
- ➔ [HTTPD Client Mode](#)
- ➔ [Advanced](#)
- ➔ [Device Management](#)

### HTTPD-Client Mode

In HTTPD\_Client mode, set the relevant parameters of HTTP

Note: HTTPD Client mode is used to communicate with HTTP Server. It encapsulate the serial data to be HTTP protocol data, then send to HTTP Server.

HTTPD Header Set Mode	new ▼
HTTPD Server address	10.10.100.200
HTTPD Server port	80
HTTPD Request Type	GET ▼ GET PUT POST
HTTPD Header path	Content-type: text/html; charset=utf-8

Custom HTTP Header

when HTTPD header set to be "old", use old setting method, that is to fill each header. When set to be "new", use new setting method, the header can be user-defined(There can't have "enter" at the end).

**Diagram 15 HTTPD Client requesting type**

(2) In "Application Setting", select Httpdclient Mode as long/short.

- ➔ [Quick Configure](#)
- ➔ [Mode Selection](#)
- ➔ [AP Interface Setting](#)
- ➔ [STA Interface Setting](#)
- ➔ [Application Setting](#)
- ➔ [Ethernet Setting](#)
- ➔ [HTTPD Client Mode](#)
- ➔ [Advanced](#)
- ➔ [Device Management](#)

**Socket Distribution settings**

Socket Distribution	off ▼
---------------------	-------

**Modbus Polling settings**

Modbus Polling	off ▼
----------------	-------

**Httpdclient Mode settings**

Httpdclient Mode	long ▼ long short
------------------	-------------------------

**485 Switch Settings**

485 selector switch	on ▼
切换时间间隔(1-350)(us)	3

**Diagram 16 HTTPD Client mode settings**

If set to short connection mode, timeout can be set within the range of 3-65535 (s).

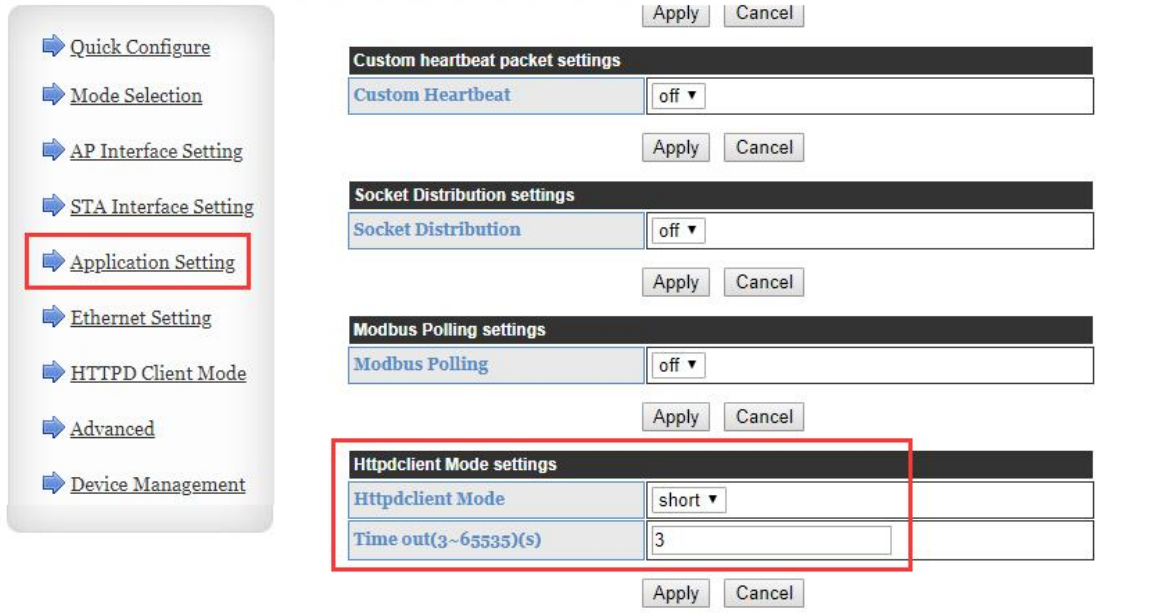

Diagram 17 HTTPD Client short connection timeout setting

AT command setting:

(1) Setting/query the Httpdclient Mode (long/short), for example:

AT+HTTPSCEN=short

(2) Setting/query the timeout of short connection mode, for example:

AT+HTTPSCT=3

### 3.1.4. Modbus TCP <=> modbus RTU

This serial server supports Modbus TCP to Modbus RTU (does not support Modbus ASCII); the network parameters of the module should correspond to the network parameters of the application software. The TCP server corresponds to the TCP client and the port must be the same. For the working mode, select Modbus TCP <=> Modbus RTU.

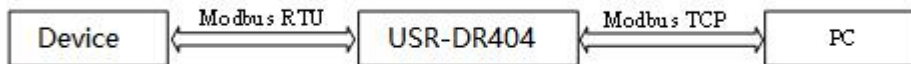

Diagram 18 modbus TCP <=> modbus RTU

Setting by AT command:

AT+TMODE=modbus

Setting by web page:

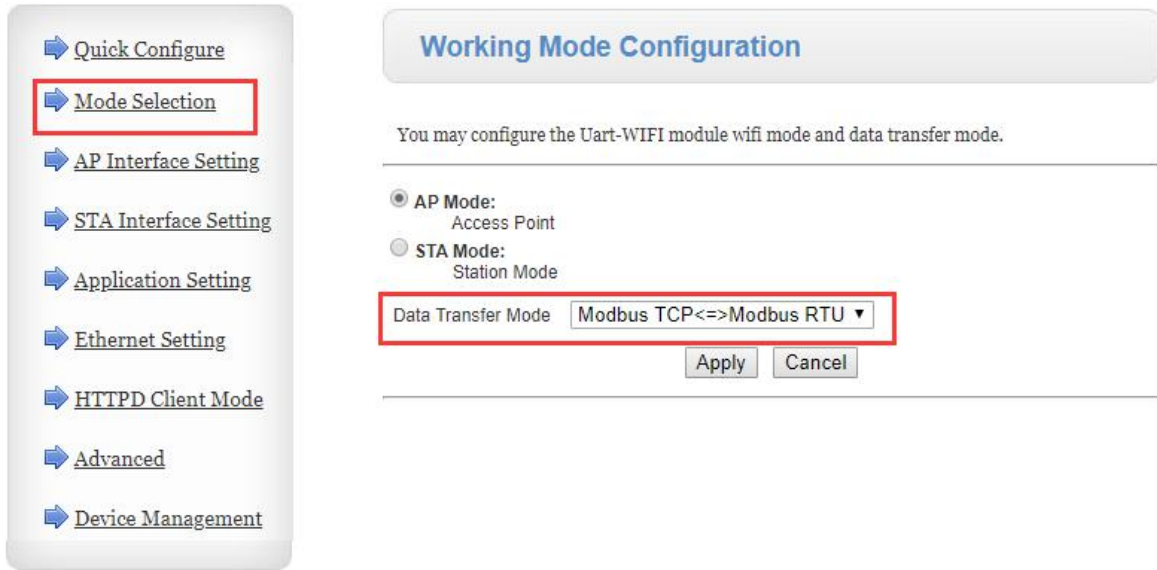

Diagram 19 Data transfer mode

### 3.1.5. AT command mode

Under AT command, send AT command to query the current status and parameters of the W610.

For details on the method and timing for entering and exiting the AT command mode, refer to the relevant section of "4.3. Command Configuration" in this manual.

## 3.2. Socket

Socket A includes TCP Server, TCP Client, UDP Server, UDP Client and socket B supports TCP Client and UDP client.

When socket A in TCP server, at most supports 24 TCP client to connect. In multi-TCP link connection mode, data transmitted from TCP will be forwarded to the serial port one by one. The data coming from the serial port will be copied into multiple copies, and one copy will be forwarded on each TCP link. The specific data flow chart shows:

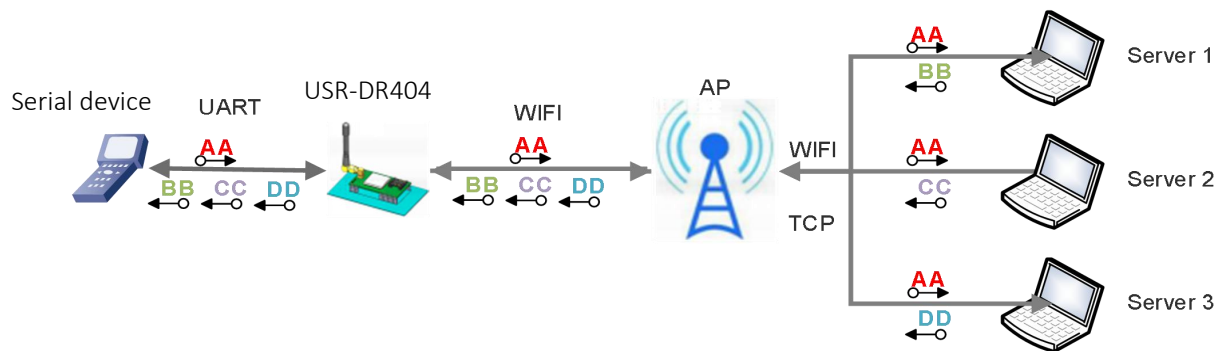

Diagram 20 Multi TCP link data transmission diagram

Socket A settings: AT+NETP/AT+TCPTO/AT+TCPLK/AT+TCPDIS



	Item	Description
1	NETP	Setting / Query TCPA's network protocol parameters
2	TCPLK	Query whether the TCP link is established
3	TCPTO	Setting/query TCP timeout
4	TCPDIS	Connect / Disconnect TCP (only valid when TCP Client)

**Form 6 Socket A related AT command**

Socket B settings: AT+TCPB/AT+TCPPTB/TCPADDB/TCPTOB/TVPLKB/TCPDIS

	Item	Description
1	TCPB	Enable/disable TCPB
2	TCPPTB	Setting/query TCPB port number
3	TCPADDB	Setting/query TCPB server address
4	TCPTOB	Setting/query TCPB timeout
5	TCPLKB	Query whether the TCPB link is established
6	TCPDIS	Connect / Disconnect TCPB

**Form 7 Socket B related AT command**

### 3.3. UART

#### 3.3.1. Parameters

Item	parameter
Baud rate	300, 600, 1200, 1800, 2400, 4800, 9600, 19200, 38400, 57600, 115200, 230400, 345600, 460800
Data	5, 6, 7, 8
Stop	1,2
Parity	None, Even, Odd
485	NFC: no hardware control

**Form 8 Serial port parameters**
**Webpage setting:**

Log in the build-in webpage, under the "Application Setting" page, as below:

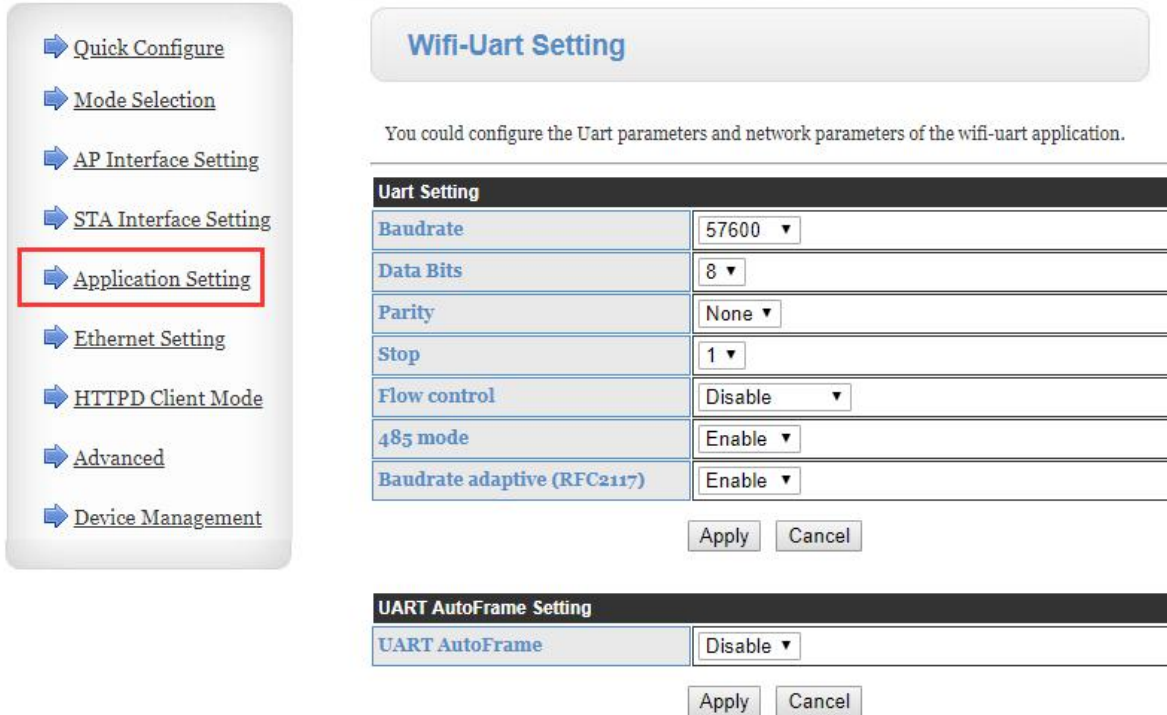

Diagram 21 Set serial port parameters on web page

AT command:

If the user needs to modify the baud rate of the DR404 to 115200bps, as follows:

AT+UART= 115200,8,1,None,NFC

### 3.3.2. UART Free framing

Take sent data from serial device to the DR404 as an example to show the steps of the free framing: if n is the free frame interval, unit is ms, when  $T1 > n$ ,  $T2 < n$ ,  $T3 < n$ ,  $T4 < n$ ,  $T5 < n$  and  $T6 > n$ , then take byte1 -byte5 as a frame, as bellow:

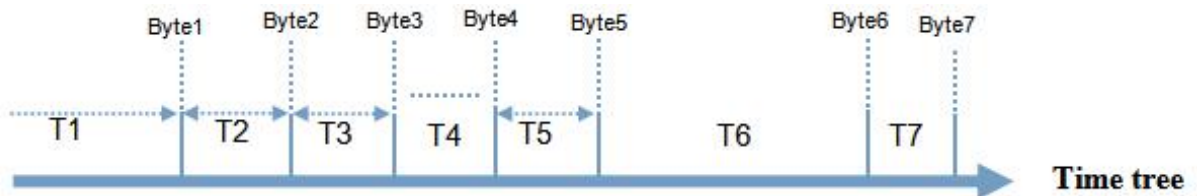

Diagram22 Switching command mode order

Default interval between 2 bytes is 10ms, that means if the time more than 10ms, this frame will be over.

And interval can change into 50ms to meet the custom's requirement, setting command are as follows:

**AT+FUARTTE=normal**

After setting, restore to the factory default value will enable it.

**AT+RELD**

**Note:** AT+RELD can not restore the above setting.

After testing, if the interval set to be 10 ms, and small amount of data, the delay time of the loopback from WIFI ->UART->WIFI is about 40~50ms.

But ,if the interval is 10ms and the MCU can not confer to send the next bytes in 10ms, and the serial data might be breaking.

If you want to restore the default interval --10ms, using the below AT command:

**AT+FUARTTE=fast**

Also need to restore to enable it.

For more AT commands, please refer to "AT command" in this manual.

### 3.3.3. UART auto-framing mode

For a fixed-length data frame on the serial port, you can turn on the UART auto-frame function and set the auto-frame trigger time and the trigger frame length. USR-DR404 will automatically compose the data received from the serial port and forward it to the network.

1. Auto framing trigger frame length: USR-DR404 receives the specified number of bytes from the serial port, forms a data frame, and forwards it to the network.

2. Auto framing trigger time: if the data received from the serial port is less than the auto framing trigger frame length within the trigger time, USR-DR404 will forward the received data to the network.

The automatic framing time is calculated from the time when the WIFI serial server receives the first byte from the serial port. As shown below:

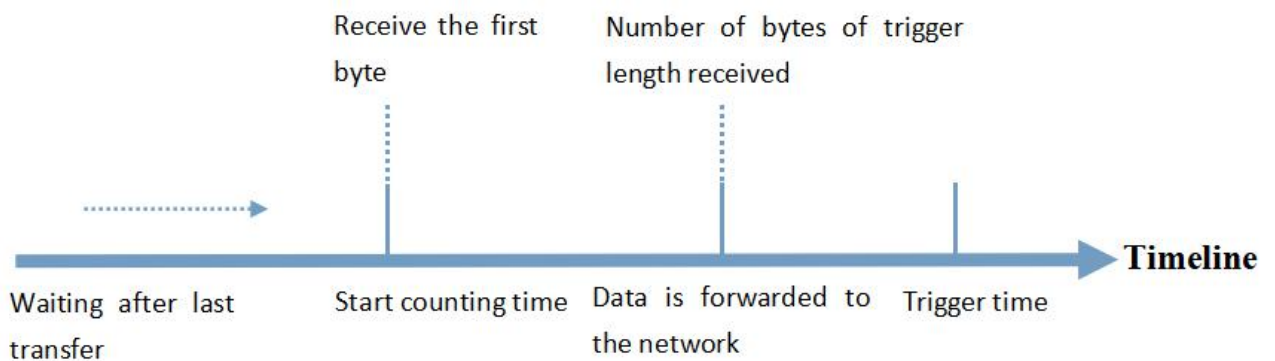

Diagram 23 Trigger Length

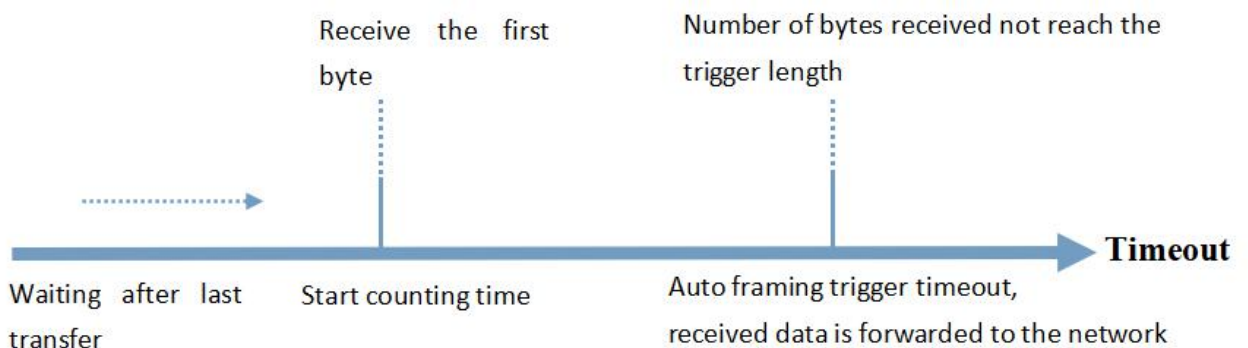

Diagram 24 Trigger Time

UART auto framing can be set through the built-in web page "Application Setting -- UART AutoFrame Setting" of DR404 or set by AT command.

### 3.4. Synchronous Band Rate (RFC2217)

Synchronous baud rate is named RFC2217. USR Similar RFC2217 make adjustments on the basis of RFC2217 protocol to improve accuracy of transmission. Enable the baud rate function of WIFI serial server via AT command:

```
AT+AABR=on
```

This command takes effect immediately and does not need to be restarted. After restarting, the WIFI serial server will restore the previous baud rate.

### 3.5. RFC2217 Protocol Description

Protocol length is 8 bytes. And values taken for example is in HEX:

Name	Packet Header	Baud Rate	Bits parameter	Parity
Bytes	3	3	1	1
Explanation	reduce misjudgment	High is in front, three bytes represent a baud rate value	data bit, stop bit, parity	Remove 4 bits of header and ignore the high bit
(115200, N,8,1)	55 AA 55	01 C2 00	83	46
(9600, N,8,1)	55 AA 55	00 25 80	83	28

Serial parameter bit:

Bit #	Explanation	Value	Description
1:0	Data bit selection	00	5 bits
		01	6 bits
		10	7 bits
		11	8 bits
2	Stop Bit	00	1 bit
		01	2bits
3	Parity Enable	00	Disable Parity
		01	Enable Parity
5:4	Parity Type	00	ODD
		01	EVEN
		10	Mark
		11	Clear
8:6	NC	000	0

### 3.6. USR-Link

When works in AP mode, DR404 will open a UDP port which number is 49000 to receive the USR-link. Connected directly to the WIFI of the DR404, phone query the SSID and set the router's SSID and password via the command under the UDP. Then the DR404 will restart automatically and connect the router, now it works in STA mode.

Protocol format description:

	Name	Bytes	Description
1	Packet Header	1	Fixed value: 0xFF
2	Length	2	Number of all bytes after length (excluding length) and before parity (excluding parity)
3	Command	1	Command type, 0x01 is the query command
4	Parity	1	The accumulated sum of all bytes after the header (excluding the header) and before the parity (excluding the parity).

**Form 9 Query Command**

	Name	Bytes	Description
1	Packet Header	1	Fixed value: 0xFF
2	Length	2	Number of all bytes after length (excluding length) and before parity (excluding parity)
3	Command	1	Command type, the reply command corresponding to the query command is 0x81
4	Number of APs	1	Number of APs searched
5	SSID1	Indefinite length	SSID of route 1
6	Terminator	1	Terminator for SSID of Router 1, fixed value is 0x00.
7	Signal strength1	1	The signal strength of router 1 network, ranges from 0 to 100, and the corresponding actual value is 0% to 100%.
8	Terminator	2	Terminator for signal strength 1, 0x0D, 0x0A.
...	...	...	.....
M	SSIDn	Indefinite length	SSID of route n
M+1	Terminator	1	Terminator for SSID of Router n, fixed value is 0x00.
M+2	Signal strength n	1	The signal strength of router n network, ranges from 0 to 100, and the corresponding actual value is 0% to 100%.
M+3	Terminator	2	Terminator for signal strength n, 0x0D, 0x0A.
M+4	Parity	1	The accumulated sum of all bytes after the header (excluding the header) and before the parity (excluding the parity).

**Form 10 Reply Command**

For example:

Mobile phone sends to WIFI serial server (hexadecimal number): FF 00 01 01 02

WIFI serial server returns to mobile phone (hexadecimal number): FF 00 14 81 02 54 45 53 54 31 00 40 0D 0A  
54 45 53 54 32 00 37 0D 0A 1F

Explanation: The mobile phone sends a query command to the WIFI serial server to query the information of the router. The information returned by the WIFI serial server to the mobile phone is: there are 2 routers, the SSID of router 1 is "TEST1" and the signal strength is 64%; the SSID of router 2 is "TEST2" and the signal strength is 55%.

Note: The router information returned by the WIFI serial server is sorted according to the signal strength.

	Name	Bytes	Description
1	Packet Header	1	Fixed value: 0xFF
2	Length	2	Number of all bytes after length (excluding length) and before parity (excluding parity)
3	Command	1	Command type, 0x02 is the setting command.
4	Reserved words	1	Default is 0x00
5	SSID	Indefinite length	SSID of route
6	Delimiter	2	SSID terminator, fixed values are 0x0D and 0x0A.
7	Password	Indefinite length	Password of route
8	Parity	1	The accumulated sum of all bytes after the header (excluding the header) and before the parity (excluding the parity).

**Form 11 Setting Command**

	Name	Bytes	Description
1	Packet Header	1	Fixed value: 0xFF
2	Length	2	Number of all bytes after length (excluding length) and before parity (excluding parity)
3	Command	1	Command type, 0x82 is the reply command corresponding to the setting command.
4	Parity	1	The parity result of the SSID. If the SSID can be found, the corresponding value is 0x01. If not, the value is 0x00.
5	Parity	1	The parity result of the password. If the password is in the correct format, the value is 0x01. If it is incorrect, the value is 0x00.
6	Parity	1	The accumulated sum of all bytes after the header (excluding the header) and before the parity (excluding the parity).

**Form 12 Reply Command**

For example:

Mobile phone sends to WIFI serial server (hexadecimal number): FF 00 0F 02 00 54 45 53 54 31 0D 0A 31 32 33 34 35

36 CE

WIFI serial server returns to mobile phone (hexadecimal number): FF 00 03 82 01 01 87

Explanation: The mobile phone sends a setting command to the WIFI serial server, sets the SSID to "TEST1" and the password to "123456". The information returned by the WIFI serial server to the mobile phone is:

There is a network with SSID "TEST1" and the password format is correct.

### 3.7. USR Cloud

USR Cloud includes Scada cloud and cloud monitor.

If your serial device supports standard MODBUS RTU data, the cloud platform can display serial device data by establishing a TCP connection with the DR404.

USR Cloud address: <https://mp.usriot.com>. After registering an account, log in.

USR Cloud server address is: tcp.mp.usriot.com, port 15000. The device number is 20 digits and the communication password is up to 8 digits.

### 3.8. Heartbeat Packet Function

In the network transparent transmission mode, the user can choose to enable the custom heartbeat packet function. The heartbeat packet can be sent to the network or serial device:

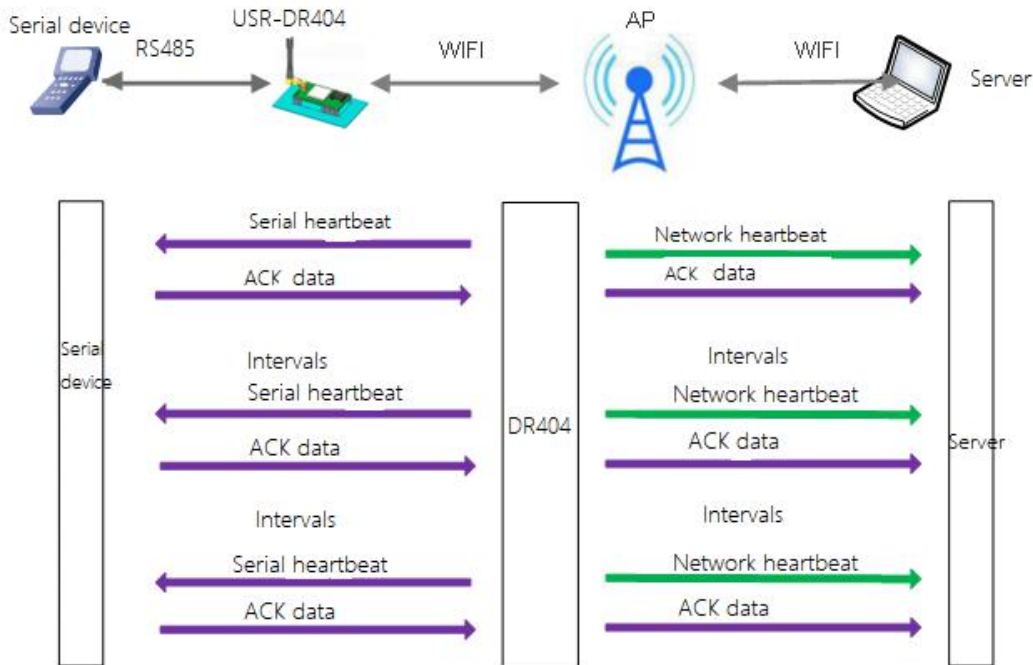

**Diagram 25 Heartbeat packet**

The main purpose of sending to the network is to maintain a connection with the server, and at the same time let the server that is idle for a long time (do not send data to the server for a long time) to detect whether the current connection status is valid.

In applications where the server sends fixed query commands to the device, in order to reduce frequent interactions, users can choose to send heartbeat packets (query commands) to the serial device instead of sending query commands from the server.

Enable the custom heartbeat packet function. AT command settings are as follows:

- (1) Enable heartbeat packet function

AT+HEARTEN=on

- (2) Set the sending direction (NET or COM) of the heartbeat packet, for example, set the heartbeat packet to be sent to the network.

AT+HEARTTP=NET

- (3) Set the heartbeat packet data (maximum 40 bytes). For example, to set the data to the string www.usr.cn, you need to first convert the string to hex 7777772E7573722E636E.

AT+HEARTDT=7777772E7573722E636E

- (4) Set the interval for sending heartbeat packets. The setting range is 1-65535s, and the default is 30s. For example, set the sending interval to 30 seconds.

AT+HEARTTM=30

Then need to set up network connections such as socket A and socket B, please refer to section 2.4. After completing the settings, restart the serial server. After socket A or socket B is connected to the server, if there is no data transmission within 30 seconds, the serial server will send the string www.usr.cn to the server.

AT commands:

	Item	Description
1	HEARTEN	Query / Se whether to enable the heartbeat packet function
2	HEARTTP	Query / Set heartbeat packet sending mode
3	HEARTDT	Query / Set heartbeat packet data
4	HEARTTM	Query/ Set heartbeat packet sending interval

**Form 13 Heartbeat packet related commands**

### 3.9. Socket Distribution

Users are allowed to send data to appointed socket connection and take the DR404 packaging the data from the net according to the protocol send to serial device if enabling the socket distribution under the transparent transport.

Users' MCU send data package according to the socket protocol and DR404 will parse the data package. If correspond with the protocol, it will be sent to the appointed socket; if not, it will return related error code and does not send it.

#### 1) Data format from serial device to module

MCU send data package according the below format, module parse and send "n" bytes data to the appointed socket connection. When the data returned, no parse and output from the serial directly.

header	Length	Parameters	Data	Parity
3	2 (n+2)	2	n	1

**Format 14 Serial transmission format**

**Header:** 0x55 0xFD 0xAA



**Length:** the total number of bytes from parameters(included) to parity (do not included), the high is in front.

**Parameters:** the first byte:common parameters, it is connecting number(socket A and socket B); 0x61 is all the device connected to the socket A, 0x62 is all the device connected to the socket B.

The second one:reserved parameters, default is 0x00

Common parameters is in front of the reserved one.

**Data:** length can be modify, the whole length is less than 4096 bytes.

**Parity:** from the parameters( included) to parity(not include), add and take the last bytes as parity.

Below is detailed application:

55 FD AA 00 03 61 00 CC 2D (Hex)

Length 00 03: the length is 3

Parameters 61 00: send data to the socket A

Data CC: the data sent is "0xCC"

Parity: 61+00+CC=2D

## 2) Data format from module to serial device

When the data received from network, module send the data package in the below format to the serial device. When the serial device send data to the module, if wrong, DR404 will send back to the serial device according to this format.

Header	Length	Parameters	Data	Parity
3	2 (n+2)	2	n	1

**Format 15 Serial transmission format**

**Header:** 0xAA 0xFD 0x55

**Length:** the total number of bytes from parameters(included) to parity (do not included), the high is in front

**Parameters:** the first byte: common parameters, it is connecting number(socket A and socket B); The data returned by Socket A is 0x61, and the data returned by Socket B is 0x62.

The second byte: reserved parameters, the seventh bit distinguish the the data from net or the module.(1:returned from module;0:returned from the net)

**Data:** if the net data, copy the data to the right position, length can be modify, length less than 4096 bytes.

If the DR404 data, return the operating code, details are as fellows:

	Return code	Description	Note
1	0x00	Header error	
2	0x01	Length error	
3	0x02	Parameters error	
4	0x04	Parity error	
5	0x10	Send failed(parameters is right but send failed)	

**Format 16 Errors**

**Parity:** from the parameters( included) to parity(not include), add and take the last bytes as parity.

Below is detailed application:

AA FD 55 00 03 61 00 CC 2D (HEX)

Length: 00 04: the length is 4

Parameters 61 00: 61—data from socket A

00—net to serial

Data CC: the data from the socket A

Sum parity: 61+00+CC= 2D

Below, we take socket A as example, serial send abc to socket A, socket A return 123 to the serial device:

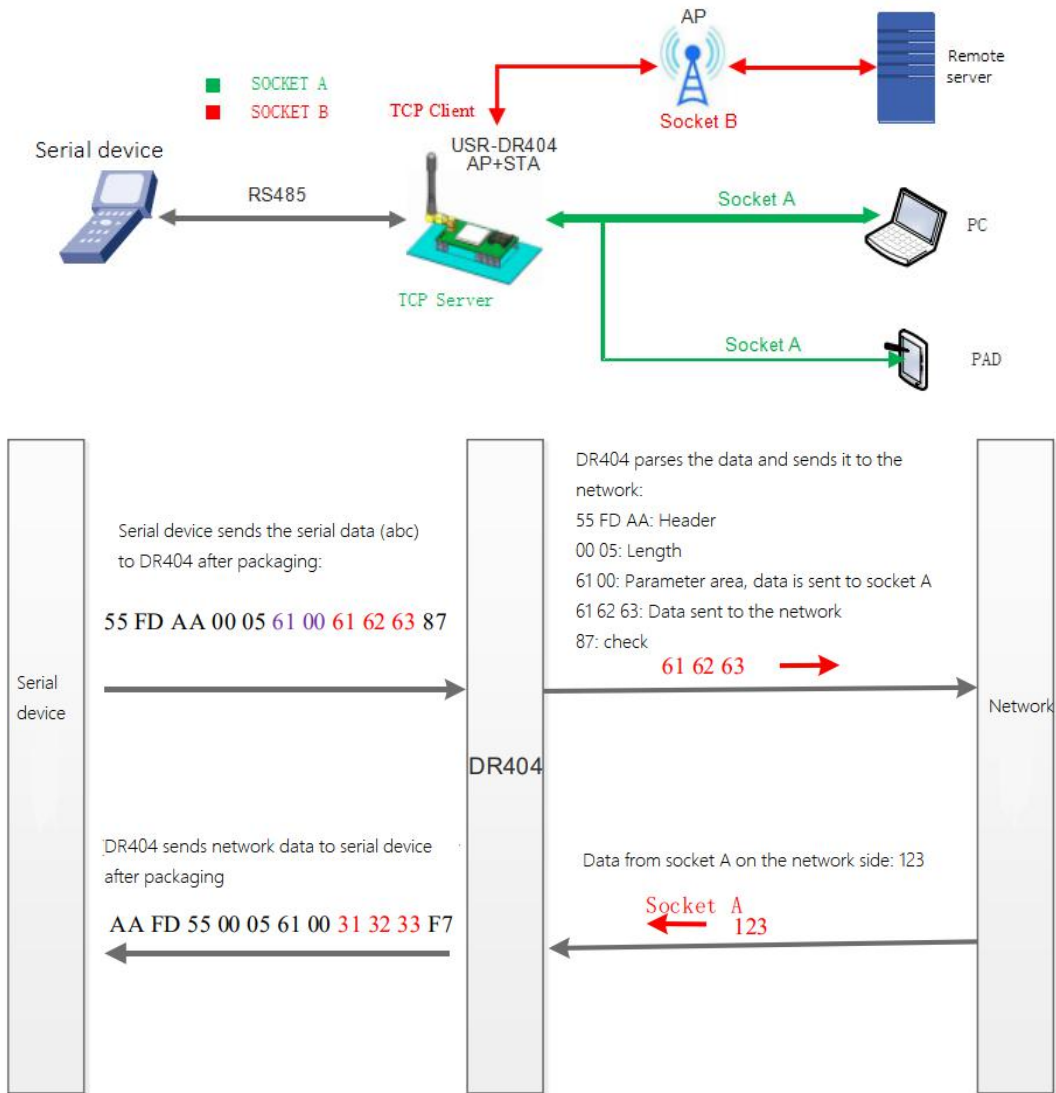

Diagram 26 Socket Distribution

AT command to enable the socket:

**AT+ TCPDPEN =on**

Others, if more function for the socket A and socket B, please refer to the 2.4.

### 3.10.Timeout Restart

Under the transparent transmission mode, enable the timeout restart function. If the DR404 no WIFI connection or connected but no communication in set time, DR404 will restart.

(1)Enable this function:

**AT+TIMEOUTEN=on**

(2)Setting the time, from 60~65535s default is 3600s, e.g. 100s

**AT+TIMEOUTT=100**

After setting, restart the DR404.

For example: AT+TIMEOUTT=100, if no connection or connected but no communication within 100s, module will restart; if there is connection or communication in 100s, the time will be cleared and regain to time.

NO.	Item	Description
1	TIMEOUTEN	Enable/ disable restart timeout
2	TIMEOUTT	Query/ setting the time for restart timeout

Form 17 Timeout Restart

### 3.11. Timing Restart

"Timing restart" is equivalent to "restart after the set time". In the non-serial port command mode, when this function is enabled, the module uses the internal clock for timing. After reaching the set time, the module will be forced to restart.

Related AT command:

1) Enable this function:

**AT+REBOOTEN=on**

2) Setting the time, can be modified from 1~720h,default is 24h, e.g. 200h

**AT+REBOOTT=200**

The parameter setting is completed, takes effect after the module is restarted, and the module will restart every 200h.

NO.	Item	Description
1	REBOOTEN	Enable/disable timing restart
2	REBOOTT	Query/setting time for timing restart

Form 18 Timing Restart

### 3.12. Modbus Polling

(1) Setting by web page

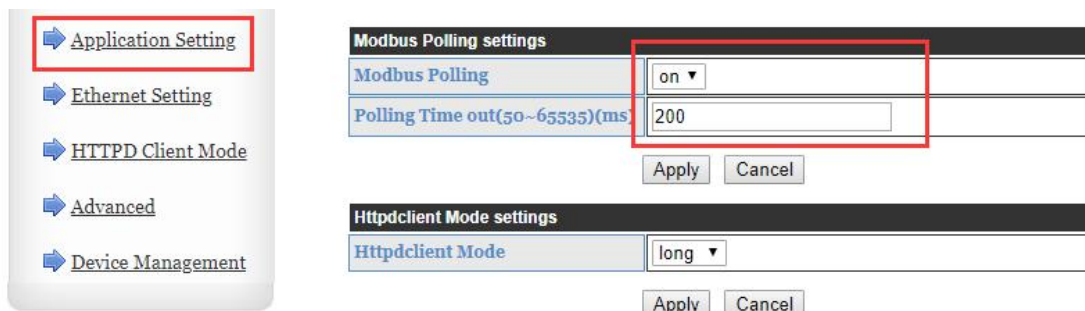

Diagram 27 Modbus polling

(2) Setting by AT command:

Enable/disable Modbus polling function, enable this function:

AT+MODBPOLLEN=on/off

Set the polling interval (50 ~ 65535) (ms), taking 200ms as an example:

AT+MODBPOLLT=200

## 3.13.Remote Upgrade

### 3.13.1 Serial server configuration

Setting by AT command:

(1) Setting/ Query remote upgrade parameters, for example, set remote upgrade to off:

AT + UPDATE = off, ycsj1.usr.cn, 30001,30 Default is off.

Query and set the remote update enable status, remote server address, remote server port, and reporting interval.

(2) Setting/ Query remote upgrade parameters

AT+MONITOR=off,10 Default is off.

Query and set the remote update enable status and reporting interval.

Setting by web page:

- ➔ [AP Interface Setting](#)
- ➔ [STA Interface Setting](#)
- ➔ [Application Setting](#)
- ➔ [Ethernet Setting](#)
- ➔ [HTTPD Client Mode](#)
- ➔ [Advanced](#)
- ➔ [Device Management](#)

**Restart Module**

Restart Module

**Load Factory Defaults**

Load Default Button

**Timeout Reboot Setting**

Timeout Function

**Reboot time Setting**

Reboot Function

**Remote Upgrade Setting**

Remote Upgrade function

Remote Server Port

Remote Server Address

Upload interval(MAX 120 min)

**Remote Monitor Setting**

Remote Monitor function

Upload interval(MAX 120 min)

**Diagram 28 Remote upgrade**

The remote upgrade function is set to open, select the port of the remote server, enter the server address, and the default reporting interval is 30min.

### 3.13.2 Remote upgrade system configuration

(1) User registration and login

Log in to <https://yicsj1.usriot.com>, click Register to register your account (if you have an account, log in directly) as shown in the figure:



<input type="text" value="account"/>
<input type="password" value="password"/>
<input type="text" value="verification code"/>
<input type="button" value="login"/>
<a href="#">forget password</a> <a href="#">register account</a>

Diagram 29 Login

After submitting the registration, the mailbox will receive an activation email, click on the link to activate.



Diagram 30 Registration

After activation, please contact our company to review the account. The account can be used normally after review. After login, the device monitoring interface is entered by default. This interface mainly displays the currently online devices.

(2)Version configuration

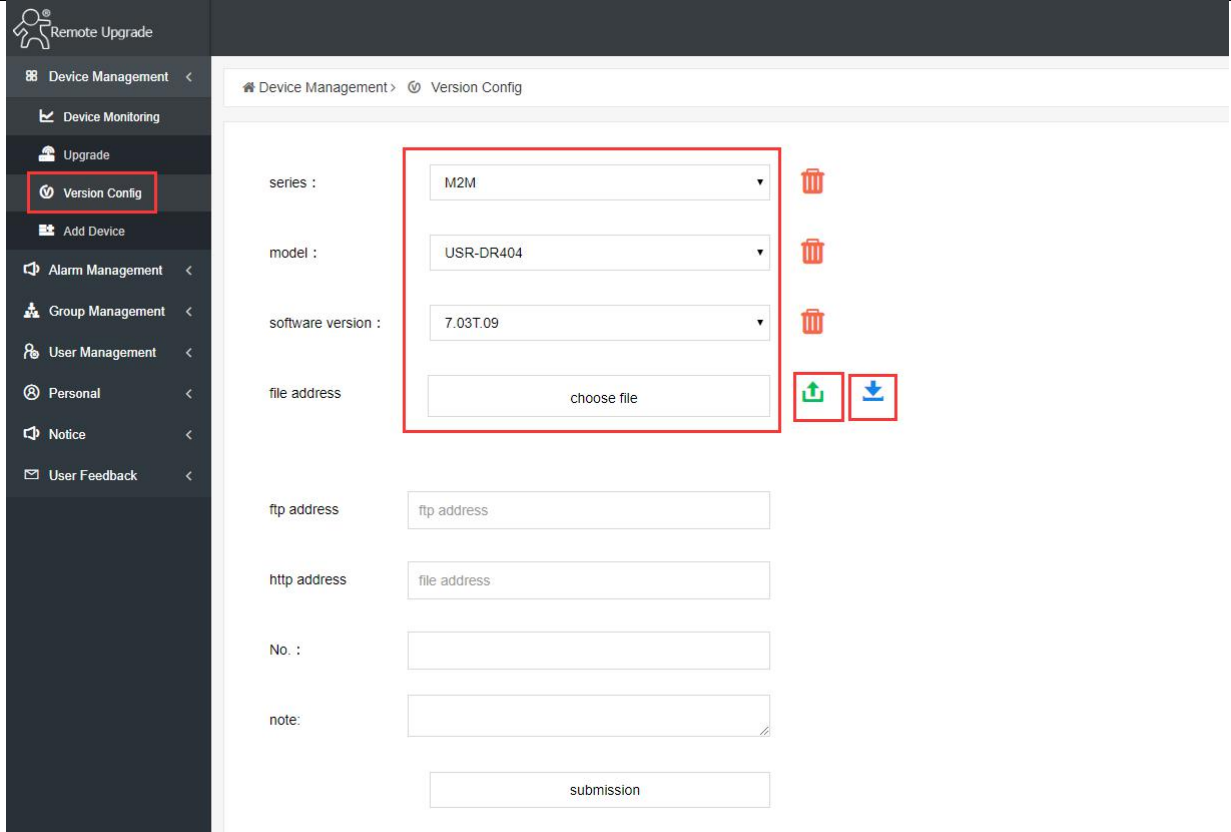

**Diagram 31** Version configuration

The version config page can be used to add, delete, modify ftp and http addresses, modify serial numbers, etc. The ftp address and http address cannot be entered manually. Click to select a file. After selecting a file, click Upload. The ftp address and http address will Automatic update, you can click the download button to download the firmware for confirmation. When iterative upgrade is required, the serial number must be increased in the order of version.

(3) Add device

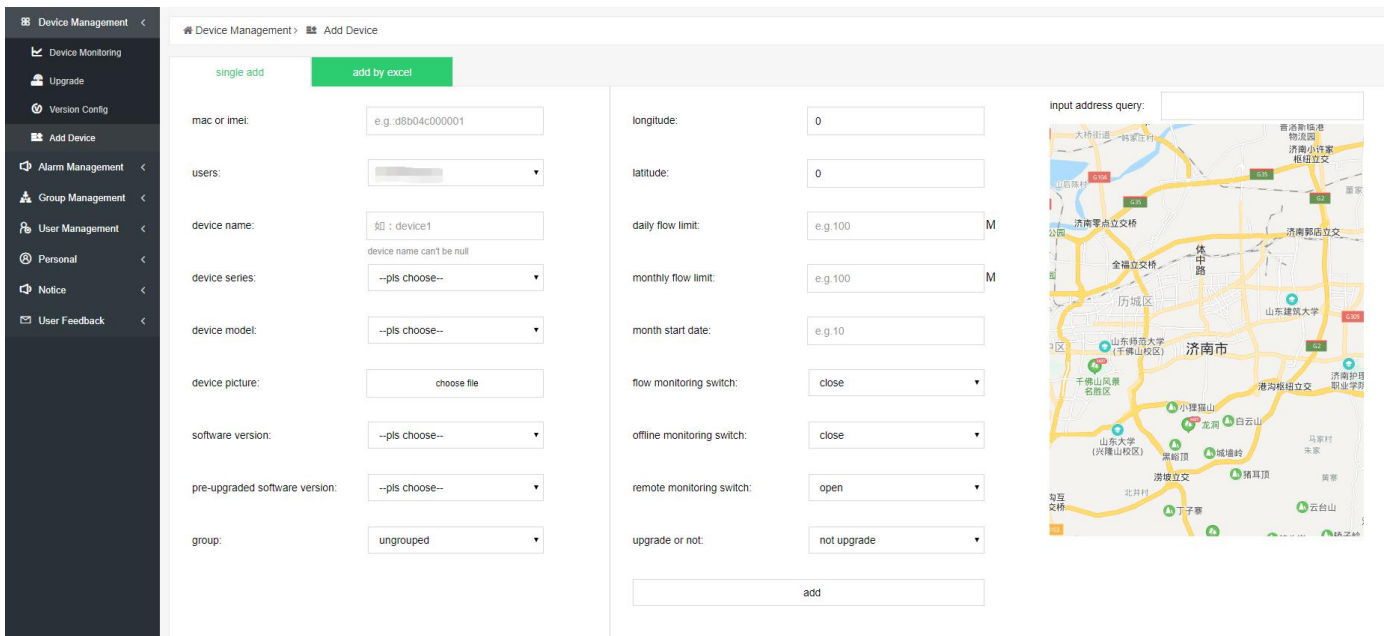

**Diagram 32 Add device**

① After the remote monitoring function is turned on, you can view the running status of the device and remotely send AT commands to control the device. Corresponding to the "device monitoring" function on the left menu, the "device monitoring" interface can see the online devices after opening.

② If you need to upgrade the equipment, choose whether to upgrade.

Note: When the device needs to be upgraded, the "software version" and the pre-upgrade version must be set to different.

(4) Device upgrade

a: Modify the software version and pre-upgrade version of the device to different version numbers

b: Select whether the device upgrade switch is on.

c: Check whether the device is successfully upgraded through the device upgrade record.

### 3.14.Websocket

DR404 supports websocket server. Instead of the ways such as HTTP GET, POST, PUT, and is faster. Providing the related websocket testing webpage for user to testing, details are as below:(10.10.100.254/websocket.html)





**Diagram 33 Websocket Webpage**

Click the “Connect” to realize a Websocket connection, then serial and webpage can transport data with each other. The Websocket server of the DR404 supports 8 clients to connect at most.

People make webpage application and have high requirement for the respond speed can contact us.

**Note:** this function uses the 8000 port of the DR404.

## 4. Product parameter setting

UAR-DR404 supports two ways to set the parameters: AT command and webpage. For the setting of AT commands, please refer to the “AT Commands” section of this document; this chapter mainly describes the Web setting methods.

### 4.1. Web Page

First time using the DR404, you can configure it via webpage. PC connects to AP interface of USR-DR404. Default SSID, IP and username, password are as follows:

Parameters	Default value
SSID	USR-DR404_XXXX
IP address	10.10.100.254
Subnet mask	255.255.255.0
Username	admin
Password	admin

**Form 19 Basic Parameters**

### 4.1.1. Open the Management Webpage

Connecting the DR404 with the wireless net card of the PC, SSID is USR-DR404\_xxxx. Enter the browser, fill the 10.10.100.254 (default IP address) and enter. Then fill the username and password( both are: admin) and enter the webpage.

Management webpage supports English, setting on the top right.

There are nine webpage in it, including: quick configure, mode selection, AP interface setting, STA interface setting, Application setting, Ethernet setting, HTTPD client mode, Advance and Device management.

### 4.1.2. Quick Configure

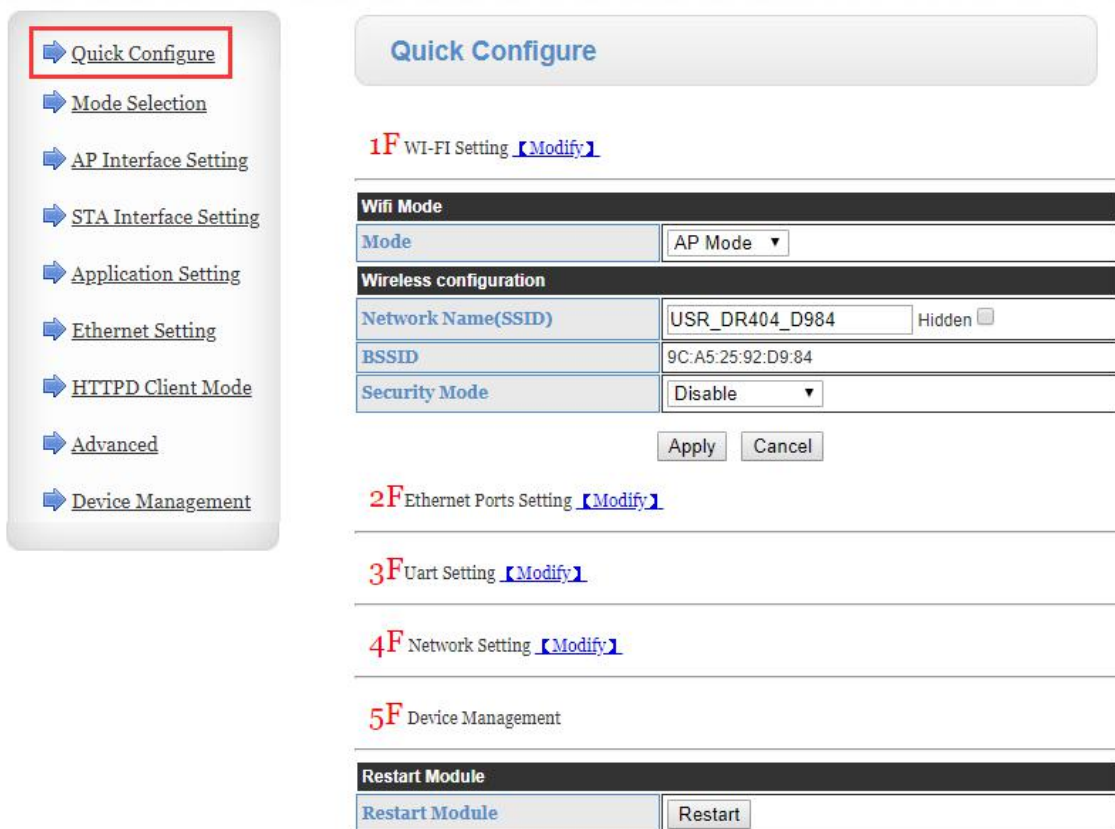

- ➔ Quick Configure
- ➔ Mode Selection
- ➔ AP Interface Setting
- ➔ STA Interface Setting
- ➔ Application Setting
- ➔ Ethernet Setting
- ➔ HTTPD Client Mode
- ➔ Advanced
- ➔ Device Management

#### Quick Configure

**1F** [WI-FI Setting](#) [【Modify】](#)

Wifi Mode	
Mode	AP Mode ▾
Wireless configuration	
Network Name(SSID)	USR_DR404_D984 <input type="checkbox"/> Hidden
BSSID	9C:A5:25:92:D9:84
Security Mode	Disable ▾
<input type="button" value="Apply"/> <input type="button" value="Cancel"/>	

**2F** [Ethernet Ports Setting](#) [【Modify】](#)

**3F** [Uart Setting](#) [【Modify】](#)

**4F** [Network Setting](#) [【Modify】](#)

**5F** [Device Management](#)

Restart Module	
Restart Module	<input type="button" value="Restart"/>

**Diagram 34 Quick Configure**

This webpage shows a way to quickly configure the USR-DR404 for user. Configure the parameters and restart to make the DR404 work normal. Of course, please click the respond webpage to configure.

### 4.1.3. Mode Selection

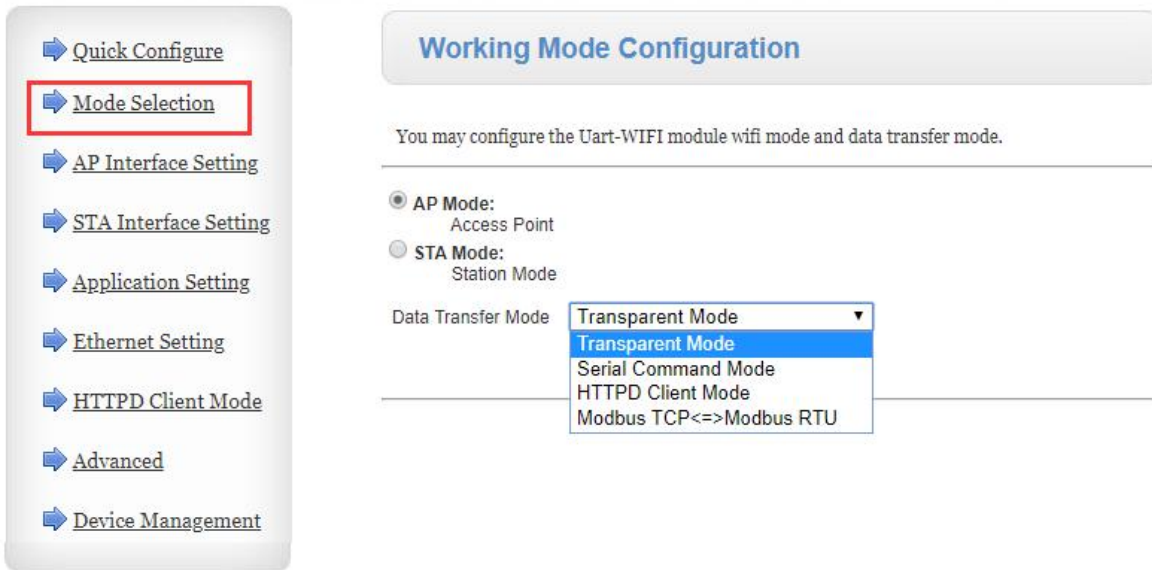

**Diagram 35 Mode Selection**

In the first page choose the work mode of the DR404:AP/ STA.

Data transfer mode including “transparent mode”, “serial command mode”, “HTTPD client mode”, “modbus TCP and modbus RTU”.

#### 4.1.4. AP Interface Setting

- ➔ [Quick Configure](#)
- ➔ [Mode Selection](#)
- ➔ [AP Interface Setting](#)
- ➔ [STA Interface Setting](#)
- ➔ [Application Setting](#)
- ➔ [Ethernet Setting](#)
- ➔ [HTTPD Client Mode](#)
- ➔ [Advanced](#)
- ➔ [Device Management](#)

### AP Interface Setting

AP Interface Setting such as SSID, Security...

---

**Wireless Network**

Network Mode	11b/g/n mixed mode ▼
Network Name(SSID)	USR_DR404_D984 <span style="float: right;">Hidden <input type="checkbox"/></span>
BSSID	9C:A5:25:92:D9:84
Frequency (Channel)	AutoSelect ▼

**USR\_DR404\_D984**

Security Mode	Disable ▼
---------------	-----------

**LAN Setup**

IP Address(Default DHCP Gateway)	10.10.100.254
Subnet Mask	255.255.255.0
DHCP Type	Server ▼

**Diagram 36 AP interface**

DR404 supports AP interface with which can management the DR404 easier and can realize the networking. Webpage is as above, including SSID, security mode and LAN setup. Both supports user defined.

### 4.1.5. STA Interface Setting

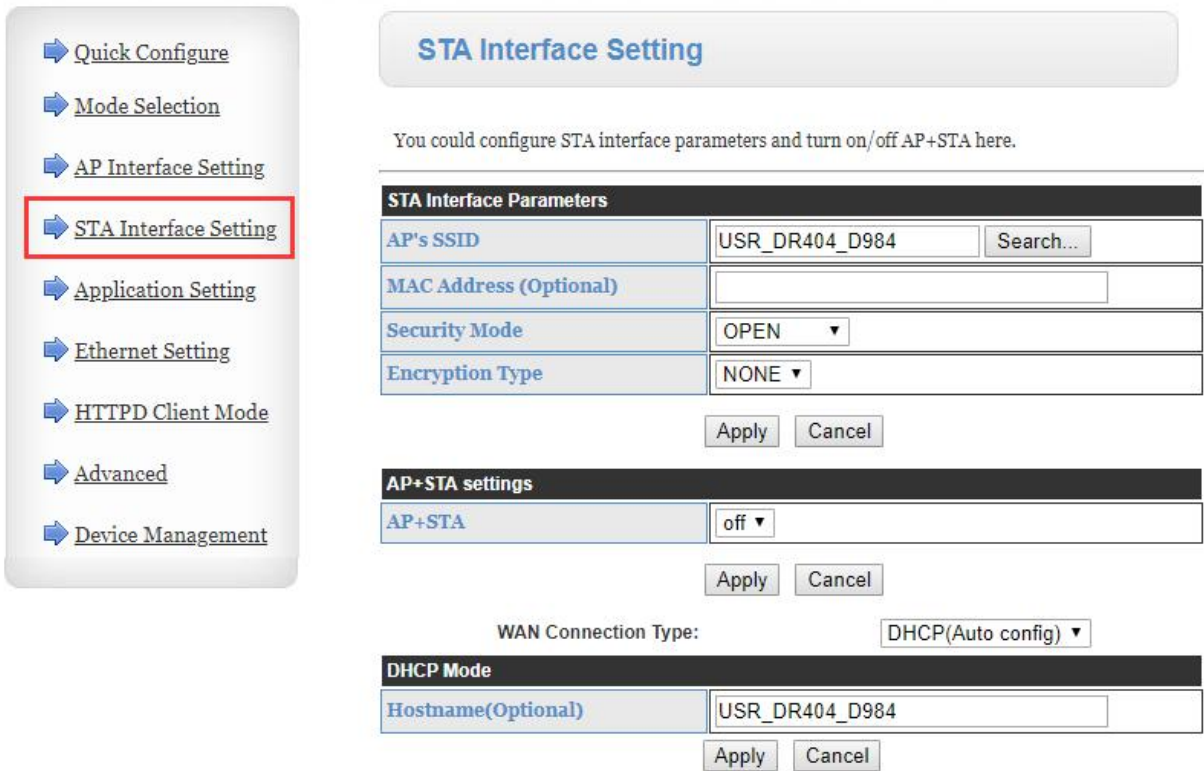

**Navigation Menu:**

- Quick Configure
- Mode Selection
- AP Interface Setting
- STA Interface Setting**
- Application Setting
- Ethernet Setting
- HTTPD Client Mode
- Advanced
- Device Management

**STA Interface Setting**

You could configure STA interface parameters and turn on/off AP+STA here.

**STA Interface Parameters**

AP's SSID	USR_DR404_D984	Search...
MAC Address (Optional)		
Security Mode	OPEN ▾	
Encryption Type	NONE ▾	

Apply Cancel

**AP+STA settings**

AP+STA	off ▾
--------	-------

Apply Cancel

WAN Connection Type: DHCP(Auto config) ▾

**DHCP Mode**

Hostname(Optional)	USR_DR404_D984
--------------------	----------------

Apply Cancel

**Diagram 37 STA Interface**

DR404 supports STA interface and can access to other wireless network, setting as above.

There are three lists in this webpage, the former one is STA interface parameters, including the SSID of the AP to connect, security mode and others. Second one is AP+STA, click to choose enable or not. The latter one is WAN connection type, including DHCP and Static IP.

### 4.1.6. Application setting

Application settings are settings for WIFI to RS485 parameters, including: setting of serial port parameters, automatic framing settings, Ethernet function settings, registration package settings and network protocol settings.

- ➔ [Quick Configure](#)
- ➔ [Mode Selection](#)
- ➔ [AP Interface Setting](#)
- ➔ [STA Interface Setting](#)
- ➔ [Application Setting](#)
- ➔ [Ethernet Setting](#)
- ➔ [HTTPD Client Mode](#)
- ➔ [Advanced](#)
- ➔ [Device Management](#)

## Wifi-Uart Setting

You could configure the Uart parameters and network parameters of the wifi-uart application.

Uart Setting	
Baudrate	57600 ▼
Data Bits	8 ▼
Parity	None ▼
Stop	1 ▼
Flow control	Disable ▼
485 mode	Enable ▼
Baudrate adaptive (RFC2117)	Enable ▼

Apply   Cancel

UART AutoFrame Setting	
UART AutoFrame	Disable ▼

Apply   Cancel

Registered Package Setting	
Registered Package Type	off ▼

Upload Manner: first: Module send registration packet when connection established; every: Send registration packet every time when module send data

Apply   Cancel

Diagram 38   WIFI-Uart setting

- ➔ [Quick Configure](#)
- ➔ [Mode Selection](#)
- ➔ [AP Interface Setting](#)
- ➔ [STA Interface Setting](#)
- ➔ [Application Setting](#)
- ➔ [Ethernet Setting](#)
- ➔ [HTTPD Client Mode](#)
- ➔ [Advanced](#)
- ➔ [Device Management](#)

**Custom heartbeat packet settings**

Custom Heartbeat	off ▼
<input type="button" value="Apply"/> <input type="button" value="Cancel"/>	

**Socket Distribution settings**

Socket Distribution	off ▼
<input type="button" value="Apply"/> <input type="button" value="Cancel"/>	

**Modbus Polling settings**

Modbus Polling	off ▼
<input type="button" value="Apply"/> <input type="button" value="Cancel"/>	

**Httpdclient Mode settings**

Httpdclient Mode	long ▼
<input type="button" value="Apply"/> <input type="button" value="Cancel"/>	

**485 Switch Settings**

485 selector switch	on ▼
切换时间间隔(1~350)(us)	3
<input type="button" value="Apply"/> <input type="button" value="Cancel"/>	

**Network A Setting**

Mode	Server ▼
Protocol	TCP ▼
Port	8899
Server Address	10.10.100.100
MAX TCP Num. (1~24)	24
TCP Time out (MAX 600 s)	0
TCP connection password authentication	Disable ▼

Diagram 39 Other settings

**Description:**

Network setting: 4 modes can be set on the network side as TCP server, TCP client, UDP server and UDP client.

When USR-DR404 is configured as a UDP server, USR-DR404 will remember the last UDP client and communicate with the last UDP client. The UDP Client mode only communicates with the target IP and port. When set to TCP Server, there is no need to enter an IP address. For other settings, you need to fill in the IP address of the other party to be connected. Enter the protocol port number at the port. The port numbers at both ends of the communication must be the same.

Socket B communicates with the server as a TCP Client and a UDP Client.

TCP connection password authentication: it only works under TCP server mode, verify the password of the TCP client which will be connected to DR404.

**Note:** working in the TCP server mode, when enable it, the first data send by the TCP client to the server is password and enter, the default password is "admin" so the first data should be: 0x61 0x64 0x6D 0x69 0x6E 0x0D 0x0A (HEX).

### 4.1.7. Ethernet setting

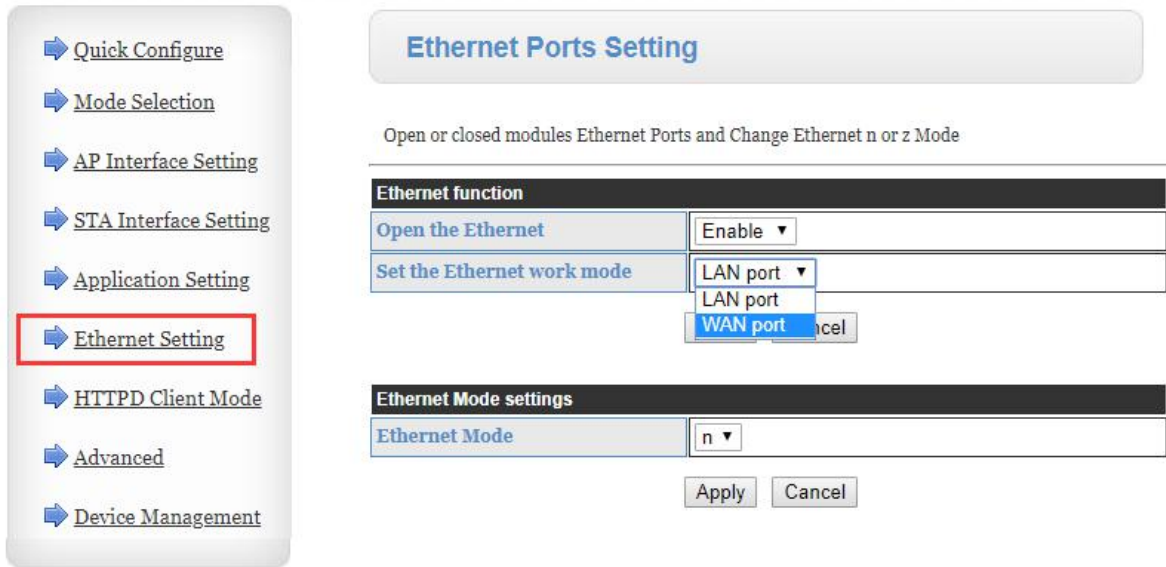

**Diagram 40 Ethernet Setting**

DR404 has one Ethernet port, this port can be work as LAN port or WAN port.

LAN port: it supports the data transmission between Ethernet to the serial or WIFI.

WAN port: DR404 can be used as secondary router which is convenient for user to network.



### 4.1.8. HTTPD Client Mode

- ➔ [Quick Configure](#)
- ➔ [Mode Selection](#)
- ➔ [AP Interface Setting](#)
- ➔ [STA Interface Setting](#)
- ➔ [Application Setting](#)
- ➔ [Ethernet Setting](#)
- ➔ [HTTPD Client Mode](#)
- ➔ [Advanced](#)
- ➔ [Device Management](#)

#### HTTPD-Client Mode

In HTTPD\_Client mode, set the relevant parameters of HTTP

Note: HTTPD Client mode is used to communicate with HTTP Server. It encapsulate the serial data to be HTTP protocol data, then send to HTTP Server.

<b>HTTPD Header Set Mode</b>	new ▼
<b>HTTPD Server address</b>	10.10.100.200
<b>HTTPD Server port</b>	80
<b>HTTPD Request Type</b>	GET ▼
<b>HTTPD Header path</b>	/abcd
<b>Custom HTTP Header</b>	Content-type: text/html; charset=utf-8

when HTTPD header set to be "old", use old setting method, that is to fill each header. When set to be "new", use new setting method, the header can be user-defined(There can't have "enter" at the end).

Diagram 41 HTTPD Client

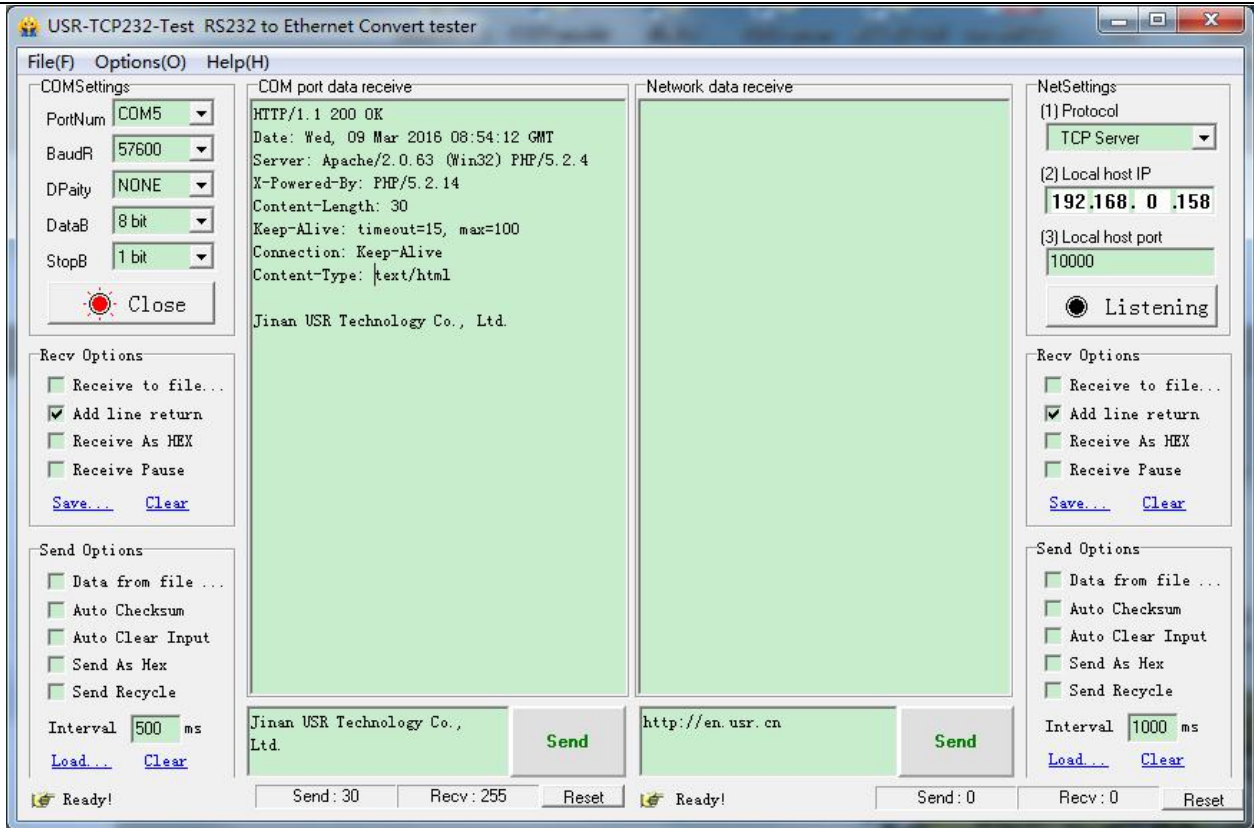

**Diagram 42 HTTPD Client Mode**

Under the HTTPD client mode, the content of the protocol header, including: server address, server port, request type, header path, header Connection and header User-Agent.

#### 4.1.9. Advanced

Under the advanced webpage, user can setup port mapping. It only works at STA mode or Ethernet port sets as WAN.

- ➔ [Quick Configure](#)
- ➔ [Mode Selection](#)
- ➔ [AP Interface Setting](#)
- ➔ [STA Interface Setting](#)
- ➔ [Application Setting](#)
- ➔ [Ethernet Setting](#)
- ➔ [HTTPD Client Mode](#)
- ➔ **Advanced**
- ➔ [Device Management](#)

## Advanced Setting

Set the module of some advanced features

Port mapping set	
Port mapping function	Enable ▾
External port (0~65535)	51968
Internal port (0~65535)	80
Port mapping time interval (0 ~ 1000) seconds	300

Note: this is used to get port forwarding from router, then to mapping the port to module

Diagram 43 Advanced

### 4.1.10. Device Management

The screenshot displays the 'Device Management' section of the web interface. On the left, a navigation menu lists several options, with 'Device Management' highlighted in a red box. The main content area shows the following sections:

- 7.03T.07**: You may configure administrator account and password, load default setting or update firmware.
- Administrator Settings**: Fields for 'Account' (admin) and 'Password' (admin), with 'Apply' and 'Cancel' buttons.
- Restart Module**: A 'Restart' button.
- Load Factory Defaults**: A 'Load Default' button.
- Timeout Reboot Setting**: 'Timeout Function' dropdown set to 'off', with 'Apply' and 'Cancel' buttons.
- Reboot time Setting**: 'Reboot Function' dropdown set to 'off', with 'Apply' and 'Cancel' buttons.
- Remote Upgrade Setting**: 'Remote Upgrade function' dropdown set to 'off', with 'Apply' and 'Cancel' buttons.
- Remote Monitor Setting**: 'Remote Monitor function' dropdown set to 'off', with 'Apply' and 'Cancel' buttons.
- Update Firmware**: 'Location:' field with a file selection button and text '未选择任何文件', and an 'Apply' button.

Diagram 44 Device Management

Device management includes username / password settings, factory reset and software upgrade functions.

**Instr:**

Restart: when user setting parameters in different webpage, click Apply to make sure it, but these parameters will be effect after restart and DR404 will reboot to fresh the original parameters.

## 4.2. AT command

### 4.2.1. Serial AT Command

UART parameters: 57600/none/8/1.

AT command can be sent by the AT command software or by programming. Take SecureCRT as an example, change from the other mode to AT command mode there always be two steps.

- ✧ Enter “+++” on the serial port (RS485), module receives and returns an “a”;
- ✧ Enter “a” on the serial port (RS485), module receives and returns “+ok”, and enter the AT command.

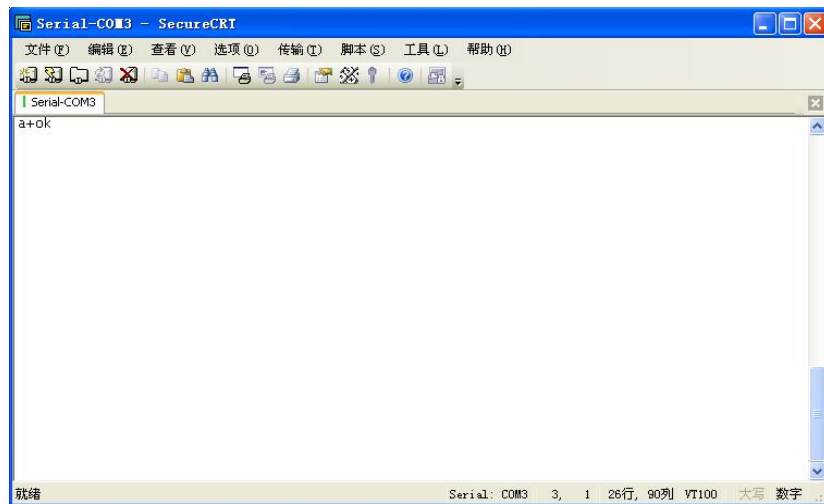

**Diagram 45 Switch to command mode**

Note: Fill “+++”and “a” need to achieve in the time to reduce the chance of entering command mode while working normally accidentally. Detail requirement are as follows:

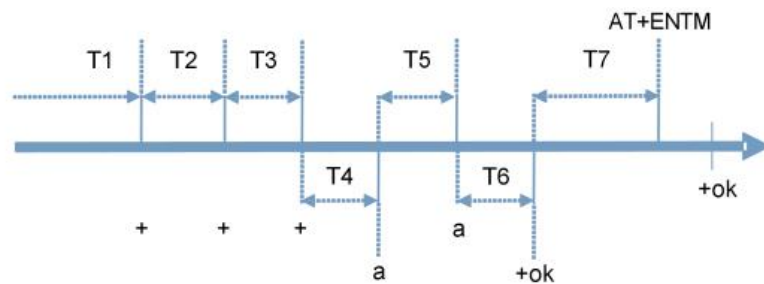

**Diagram 46 Switch to command mode**

Time requirement:

T1>the interval of serial port package

T2<300ms

T3<300ms

T5<3s

Change transparent transmission mode , HTTPD Client mode to AT command mode :

1. Serial device send “+++”to module continuously. Module received ‘+++’ then returned an “a” .

2. After receiving the ‘a’ returned by the module, the device must send another confirmation code ‘a’ to the module within 3 seconds.

3. The module will return ‘+ok’, and enter AT command mode.

Change AT command mode to transparent transmission mode, HTTPD Client:

1. Serial device send “AT+ENTM”to module.

2. After the module receive the commend, feedback “+ok”, then back to the previous working mode.

Note: The specific AT command requires a ENTER, but the "+++" and "a" sent by entering the AT command process do not need a ENTER.

In AT command mode, you can view all AT commands and descriptions of USR-DR404 through the following help commands, as follows:

AT + H

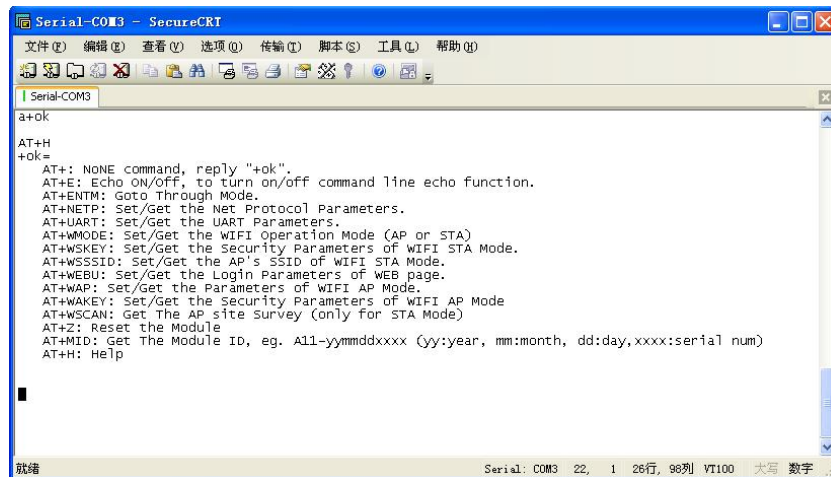

Diagram 47 AT command mode

In order to enter the AT command mode to set parameters conveniently, our company provides "AT command software":

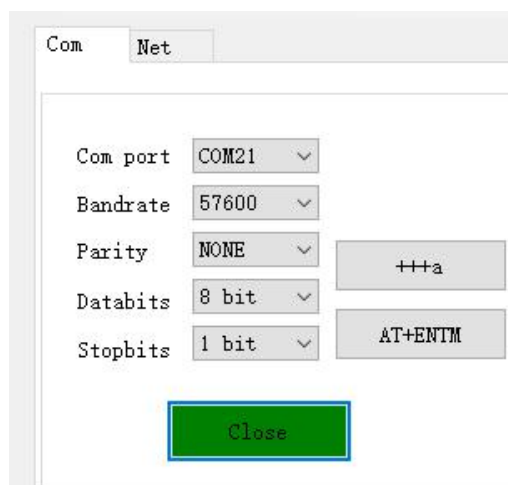

Diagram 48 Search via serial port

Click “Open”, send “+++ a”, receive the response “+ ok”, then enter the AT command to be sent in the left operation area. After the setting is completed, click “AT + Z” to restart the module, and the parameter settings can be completed.

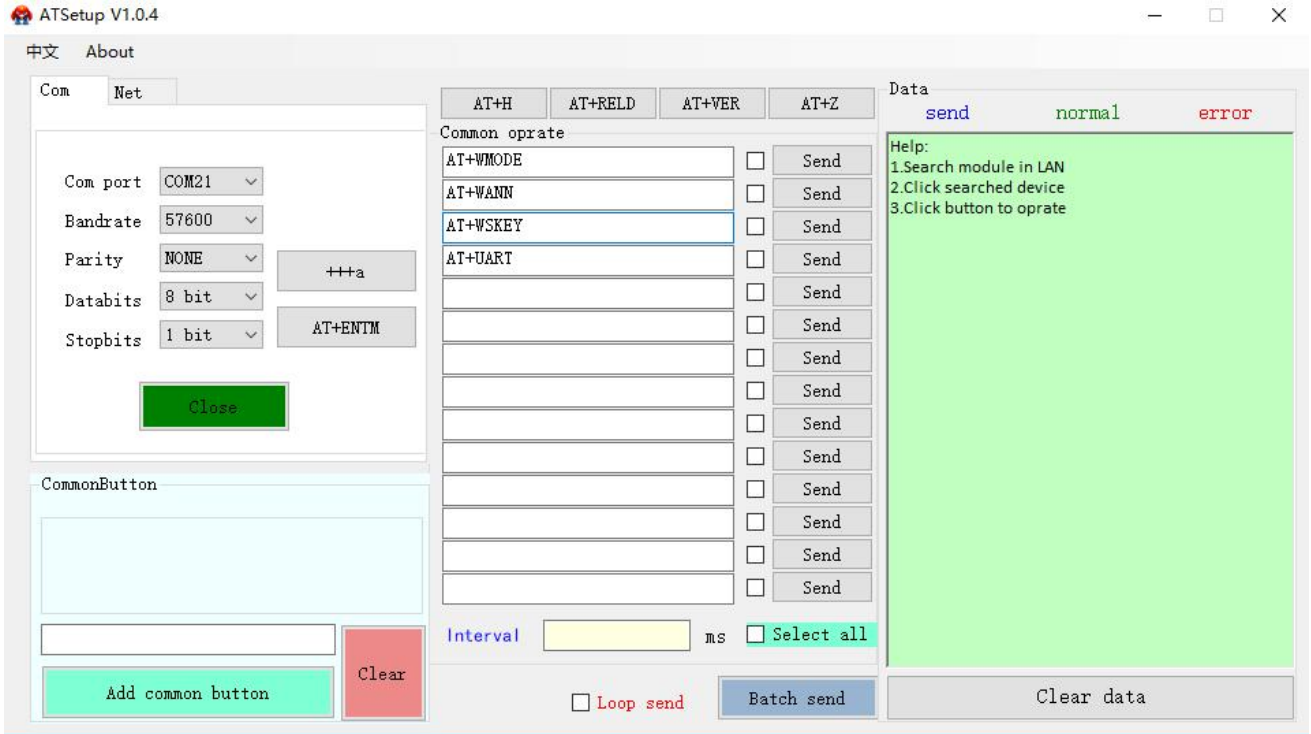

Diagram 49 AT command software

#### 4.2.2. Net AT command

The above is the AT command setting through the serial port. The user can also set the AT command through WIFI. First, the computer establishes a network connection with USR-DR404, and uses AT Setup software.

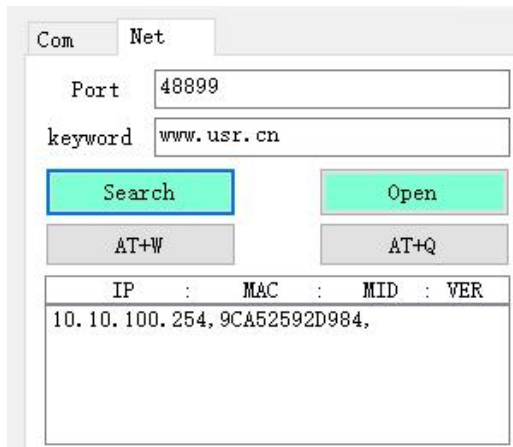

Diagram 50 Web search

Click "Search", the searched USR-DR404 will be displayed, click the USR-DR404, and then set through the left operation area (the method is the same as the serial port setting)

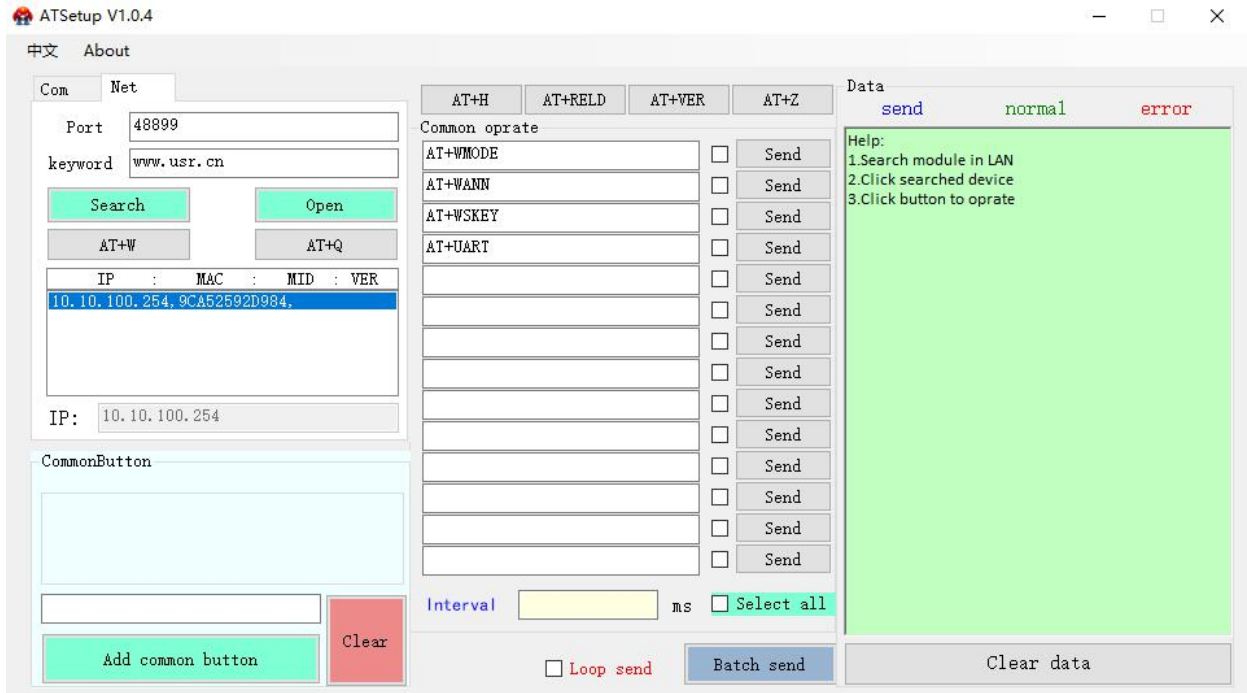

Diagram 51 AT command software

### 4.3.3 Command Format

Based on the ASCII command , the format of the AT command are as below:

- Format description:
  - < >: the content that have to be included
  - [ ]: the part can be select
- Command:
  - AT+<CMD>[op][para-1,para-2,para-3,para-4...]<CR>
  - AT+: command prefix
  - [op]L: command operating code, parameters setting or query;
    - "=": parameters setting
    - "NULL" : query
  - [para-n] : fill when setting the parameters
  - <CR>: end, enter, ASCII code,; 0x0a or 0xd

**Note:** When echoing, the terminator is automatically converted to 0x0a0d. When entering a command, the "AT + <CMD>" characters are automatically echoed to uppercase, and the parameters remain unchanged.

- Response data
  - + <RSP> [op] [para-1, para-2, para-3, para-4...] <CR> <LF> <CR> <LF>
  - +: the response prefix
  - RSP: response string ,including:
    - Ok
    - Err
  - [op]: =
  - [para-n]: return parameters or the error code:



<CR>:ASCII code: 0x0d;

<LF>: ASCII code :0x0a;

■ Error code

Error	State
-1	Invalid command format
-2	Invalid command
-3	Invalid Operator
-4	Invalid Parameters
-5	Operation not allowed

#### 4.3.4 AT command

Command	Function
E	Enable/Disable echo function(DR404 does not support)
ENTM	Enter transparent transmission mode
NETP	Query/Set Network protocol parameters
UART	Query/Set serial port parameters
UARTF	Enable/Disable auto-frame function
UARTFT	Query/Set auto-frame trigger time
UARTFL	Query/Set auto-frame trigger length
TMODE	Query/Set data transmission mode (transparent transmission mode or protocol mode)
WMODE	Query/Set WIFI mode (AP or STA)
WSKEY	Query/Set encryption parameters in STA mode
WSSID	Query/Set SSID of connected AP in STA mode
WSLK	Query the connection status in STA mode
WEBU	Query/Set Web Server username and password
WAP	Query/Set AP mode parameters
WAKEY	Query/Set encryption parameters in AP mode
MSLP	Set the module to enter low power mode, turn off WIFI
WSCAN	Search surrounding AP in STA mode
TCPLK	Query socket A TCP connection connect/disconnected
TCPDIS	Query/Set establish TCP connection enable/disable(Only take effect in TCP Client mode)
WANN	Query/Set network parameters in STA mode(WAN interface parameters)
LANN	Query/Set network parameters in AP mode(LAN interface parameters)

TCPTO	Query/Set timeout re-connection time of socket A
MAXSK	Query/Set maximum TCP Clients in TCP Server work mode
TCPB	Enable/Disable socket B
TCPPTB	Query/Set Socket B port number
TCPADDB	Query/Set Socket B server address
TCPTOB	Query/Set timeout re-connection time of socket B
TCPLKB	Query socket B TCP connection connect/disconnected
EPHY	Enable/Disable Ethernet interface
RELD	Reset the module
FUDLX	Enable/Disable RS485
IDFIR	Enable / disable sending ID when the connection is first established
IDEVE	Enable / disable sending ID before each data packet
AABR	Enable/Disable RFC2217 function
DHCPDEN	Enable/Disable DHCP server function of LAN port
HIDESSID	Query/Set whether to hide SSID of DR404 in AP mode
DOMAIN	Query/Set web server domain name
Z	Restart the module
AT+FAPSTA	Enable/Disable AP+STA function
MID	Query module's MID
VER	Query firmware version
H	Query help information
WSQY	Query/Set RSSI threshold(percentage) to switch among three AP in STA mode
HTPMODE	Query/Set HTTP Client mode parameters configuration way(new/old)
HTTPURL	Query/Set HTTP Server address and port in HTTP Client mode(old)
HTTPTP	Query/Set HTTP requesting method in HTTP Client mode(old)
HTTTPH	Query/Set HTTP header path in HTTP Client mode (old)
HTTPCN	Query/Set HTTP header connection in HTTP Client mode (old)
HTTTPUA	Query/Set HTTP header User-Agent in HTTP Client mode (old)
HTPSV	Query/Set HTTP Server address and port in HTTP Client mode (new)
HTPTP	Query/Set HTTP requesting method in HTTP Client mode (new)
HTPURL	Query/Set HTTP URL in HTTP Client mode (new)
HTPHEAD	Query/Set HTTP header in HTTP Client mode (new)
HTTTPSCEN	Query/Set HTTPD Client connection mode (long/short)
HTTTPSCT	Query/Set HTTPD Client Short Connection Timeout(3-65535s)
REGEN	Query/Set registration package type
REGTCP	Query/Set registration packet sending type

WTPWR	Query/Set transmitting power
REGCLOUD	Query/Set USR Cloud ID and password
FVER	Query/Set module software version (N-Ver、Z-Ver)
REGUSR	Query/Set custom registration package content
TCPDPEN	Enable/Disable socket distribution function
HEARTEN	Enable/Disable custom heartbeat packet function
HEARTTP	Query/Set custom heartbeat packet sending direction
HEARTDT	Query/Set custom heartbeat packet data
HEARTTM	Query/Set sending interval of custom heartbeat packet
REBOOTEN	Enable/Disable timing restart function
REBOOTT	Query/Set timing restart time
TIMEOUTEN	Enable/Disable timeout restart function
TIMEOUTT	Query/Set timeout restart time
MODBPOLLEN	Enable/disable Modbus polling function
MODBPOLLT	Query/Set polling time interval(50~65535)(ms)
UPDATE	Query/Set whether to enable the remote upgrade status, remote server address, remote port , report interval.
MONITOR	Query/Set whether enable the remote monitor and report interval.

**<Note>:**

- 1.This AT command set is for onboard WIFI module, which can be used for query, setting WIFI serial server parameters.
- 2.USR-DR404 can work in AP mode or STA mode, and the WIFI parameters need to be set with different commands.

#### 4.3.4.1. AT+E

Function: enable/ disable echo function

Format:

AT+E<CR>

+ok<CR>< LF ><CR>< LF >

From the transparent mode to AT command, module default enable echo function, after the first time user enter the AT+E, disable the echo function, the second time user enter the “AT+E” enable the echo function.

#### 4.3.4.2. AT+ENTM

Function: enter the transparent transmission mode.

Format:

AT+ENTM<CR>

+ok<CR>< LF ><CR>< LF >

After the command is executed correctly, the module switches from command mode to transparent transmission mode. If need to enter the command mode again, enter "+++" and the confirmation code to return to the command mode.

### 4.3.4.3. AT+NETP

Function: Query/Set network protocol parameters

Format:

Query : AT+NETP<CR>

+ok=<protocol,CS,port,IP><CR>< LF ><CR>< LF >

Setting: AT+NETP=<protocol,CS,port,IP><CR>

+ok<CR>< LF ><CR>< LF >

Parameters:

- protocol: protocol type, including
  - ✧ TCP
  - ✧ UDP
- CS: Client or server, including
  - ✧ SERVER: server
  - ✧ CLIENT: client
- port: protocol port, decimal number, less than 65535

Note: when in TCP Server and UDP Server mode, cannot be 80(HTTP port), 8000(websocket port), 49000(usr-link port).

- IP: when module works as TCP client or UDP, server address(can be a IP address or a domain name of server).

After restarting the module, parameters take effect.

### 4.3.4.4. AT+UART

Function: Query/Set serial parameters

Format:

Query : AT+UART<CR>

+ok=<baudrate,data\_bits,stop\_bit,parity,flowctrl><CR>< LF ><CR>< LF >

Setting: AT+UART=<baudrate,data\_bits,stop\_bit,parity,flowctrl><CR>

+ok<CR>< LF ><CR>< LF >

Parameters:

- baudrate: band rate,
  - ✧ 300, 600, 1200, 1800, 2400, 4800, 9600, 19200, 38400, 57600, 115200, 230400, 345600, 460800
- data\_bits: data bit

- ◇ 5, 6, 7, 8
- stop\_bits: stop bit
  - ◇ 1, 2
- parity: parity
  - ◇ NONE
  - ◇ EVEN
  - ◇ ODD
- flowctrl: Hardware flow control (CTSRTS)
  - ◇ NFC: No hardware flow control
  - ◇ FC: Hardware flow control

After restarting the module, parameters take effect.

#### 4.3.4.5. AT+UARTF

Function: Enable/Disable auto-frame function

Format:

Query : AT+ UARTF<CR>

+ok=<para><CR>< LF ><CR>< LF >

Setting: AT+ UARTF=<para ><CR>

+ok<CR>< LF ><CR>< LF >

Parameters:

- para: disable or enable, means disable or enable this function.

#### 4.3.4.6. AT+UARTFT

Function: Query/Set auto-frame trigger time

Format:

Query : AT+ UARTFT<CR>

+ok=<time><CR>< LF ><CR>< LF >

Setting: AT+ UARTFT=<time><CR>

+ok<CR>< LF ><CR>< LF >

Parameters:

- time: auto-frame trigger time, unit is ms. Range: 100~10000.

### 4.3.4.7. AT+UARTFL

Function: Query/Set auto-frame trigger length

Format:

Query : AT+ UARTFL<CR>

+ok=<len><CR>< LF ><CR>< LF >

Setting: AT+ UARTFL=<len><CR>

+ok<CR>< LF ><CR>< LF >

Parameters:

- len: auto-frame trigger length, unit is byte. Range: 16~4096.

### 4.3.4.8. AT+TMODE

Function: Query/Set data transmission mode(transparent transmission mode or protocol mode)

Format:

Query : AT+TMODE<CR>

+ok=<tmode><CR>< LF ><CR>< LF >

Setting: AT+ TMODE=<tmode><CR>

+ok<CR>< LF ><CR>< LF >

Parameters:

- tmode: data transmission mode, including
  - ✧ Through: transparent transmission mode
  - ✧ Agreement: serial command mode
  - ✧ Modbus: Modbus TCP<=>Modbus RTU mode
  - ✧ Httpdclient: HTTPD Client mode

After restarting the module, parameters take effect.

[Note: After power on, works in transparent transmission mode by default.](#)

### 4.3.4.9. AT+WMODE

Function: Query/Set WIFI mode (AP or STA)

Format:

Query : AT+WMODE<CR>

+ok=<mode><CR>< LF ><CR>< LF >

Setting: AT+ WMODE=<mode><CR>

+ok<CR>< LF ><CR>< LF >

Parameters:

- mode: WIFI mode, including
  - AP: Wireless access point mode
  - STA: Wireless terminal mode

After restarting the module, parameters take effect.

#### 4.3.4.10. AT+WSKEY

Function: Query/Set encryption parameters in STA mode.

Format:

Query : AT+WSKEY<CR>

+ok=<auth,ency,key><CR>< LF ><CR>< LF >

Setting: AT+ WSKEY=< auth,ency,key><CR>

+ok<CR>< LF ><CR>< LF >

Parameters:

- auth: Authentication mode, including
  - ✧ OPEN
  - ✧ SHARED
  - ✧ WPAPSK
  - ✧ WPA2PSK
- encry: Encryption algorithm, including
  - ✧ NONE: valid when auth=OPEN.
  - ✧ WEP-H: valid when auth=OPEN or SHARED (WEP, HEX)
  - ✧ WEP-A: valid when auth=OPEN or SHARED (WEP, ASCII)
  - ✧ TKIP: valid when auth= WPAPSK/WPA2PSK
  - ✧ AES: valid when auth= WPAPSK/WPA2PSK
- key: password, when encry=WEP-H, password is hexadecimal, 10 or 26 digits; when encry=WEP-A, password is ASCII, 5 or 13 digits; when WPA-PSK and WPA2-PSK, password is ASCII, 8~63digits.

This parameter only valid in STA mode, after restarting the module, parameters take effect. But can also be set in AP mode.

### 4.3.4.11. AT+WSSSID

Function: Query/Set AP's SSID in STA mode.

Format:

Query : AT+WSSSID<CR>

+ok=<ap's ssid><CR>< LF ><CR>< LF >

Setting: AT+ WSSSID=<ap's ssid ><CR>

+ok<CR>< LF ><CR>< LF >

Parameters:

- ap's ssid: AP's SSID

This parameter only valid in STA mode, after restarting the module, parameters take effect. But can also be set in AP mode.

### 4.3.4.12. AT+WSLK

Function: Query the link status in STA mode (only available in STA mode)

Format:

Query : AT+ WSLK<CR>

+ok=<ret><CR>< LF ><CR>< LF >

Parameters:

- ret:
- If not connected: Returns "Disconnected".
- If connected: Returns "SSID of AP (MAC of AP)"

This parameter only valid in STA mode.

### 4.3.4.13. AT+WEBU

Function: Query/Set web server username and password.

Format:

Query : AT+WEBU<CR>

+ok=<usr,password><CR>< LF ><CR>< LF >

Setting: AT+ WEBU=< usr,password ><CR>

+ok<CR>< LF ><CR>< LF >

Parameters:

- usr: username



- password: password.

#### 4.3.4.14. AT+WAP

Function: Query/Set parameters in AP mode

Format:

Query : AT+WAP<CR>

+ok=<wifi\_mode,ssid,channel><CR>< LF ><CR>< LF >

Setting: AT+ WAP=<wifi\_mode,ssid,channel><CR>

+ok<CR>< LF ><CR>< LF >

Parameters:

- wifi\_mode: WIFI mode, including

- ✧ 11BG

- ✧ 11B

- ✧ 11G

- ✧ 11BGN

- ✧ 11N

- ssid: SSID in AP mode

- channel: WIFI channel, AUTO or CH1~CH11

This parameter only valid in AP mode, after restarting the module, parameters take effect. But can also be set in STA mode.

AT+WAP=11BGN,SOCKAB+STA-TEST,Auto

#### 4.3.4.15. AT+WKEY

Function: Query/Set encryption parameters in AP mode

Format:

Query : AT+WKEY<CR>

+ok=<auth,encry,key><CR>< LF ><CR>< LF >

Setting: AT+ WKEY=< auth,encry,key><CR>

+ok<CR>< LF ><CR>< LF >

Parameters:

- auth: Authentication mode, including

- ✧ OPEN

- ✧ SHARED

- ✧ WPAPSK
- ✧ WPA2PSK
- encry: Encryption algorithm, including
  - ✧ NONE: valid when auth=OPEN
  - ✧ WEP-H: valid when auth=OPEN or SHARED (WEP, HEX)
  - ✧ WEP-A: valid when auth=OPEN or SHARED (WEP, ASCII)
  - ✧ TKIP: valid when auth= WPAPSK/WPA2PSK.
  - ✧ AES: valid when auth= WPAPSK/WPA2PSK
  - ✧ TKIPAES: valid when auth= WPAPSK/WPA2PSK
- key: password, when encry=WEP-H, password is hexadecimal, 10 or 26 digits; when encry=WEP-A, password is ASCII, 5 or 13 digits; when WPA-PSK and WPA2-PSK, password is ASCII, 8~63digits.

This parameter only valid in AP mode, after restarting the module, parameters take effect. But can also be set in STA mode.

#### 4.3.4.16. AT+MSLP

Function: Module enters sleep mode (whether the module works in AP or STA mode, WIFI is not available at this time)

Format:

Query : AT+ MSLP <CR>

+ok=<sta.><CR>< LF ><CR>< LF >

Setting: AT+ MSLP=<on/off><CR>

+ok<CR>< LF ><CR>< LF >

Parameters:

- Query: sta: Returns whether the module sleeps, such as:
  - ✧ on, Indicates no sleep
  - ✧ off, sleep
- Setting: off: module enters sleep mode,  
on: module exits sleep mode

When the module enters the sleep mode, enter AT + MSLP = on again, module exits the sleep mode. The mode is still command mode.

#### 4.3.4.17. AT+WSCAN

Function: Search around AP

Format:

AT+ WSCAN<CR>

+ok=<ap\_site><CR>< LF ><CR>< LF >

Parameters:

- ap\_site: Searched APs

The first line returned is "RSSI, SSID, BSSID, Channel, Encryption, Authentication", which are the signal strength, network name, MAC address, channel, authentication mode, and encryption algorithm.

#### 4.3.4.18. AT+TCPLK

Function: Query whether TCP connection is established

Format:

AT+ TCPLK<CR>

+ok=<sta><CR>< LF ><CR>< LF >

Parameters:

- sta.: Returns whether TCP connection is established, for example:
  - ✧ on, TCP connection is established
  - ✧ off, TCP connection is not established

#### 4.3.4.19. AT+TCPDIS

Function: Connect / Disconnect TCP (only valid when TCP Client)

Format:

Query : AT+ TCPDIS <CR>

+ok=<sta.><CR>< LF ><CR>< LF >

Setting: AT+ TCPDIS=<on/off><CR>

+ok<CR>< LF ><CR>< LF >

Parameters:

- When querying, sta.: Returns whether the TCP Client is linkable, for example
  - on, connectable
  - off, not connectable
- When setting, "off" sets the module as unlinkable. Immediately after the command is completed, the module disconnects the link and does not reconnect. "On" sets the module to a linkable state. After the command is completed, the module will immediately reconnect to the server.

### 4.3.4.20. AT+WANN

Function: Query/Set WAN Setting, only valid in STA mode.

Format:

Query : AT+WANN<CR>

+ok=<mode,address,mask,gateway><CR>< LF ><CR>< LF >

Setting: AT+ WANN=< mode,address,mask,gateway ><CR>

+ok<CR>< LF ><CR>< LF >

Parameters:

- mode: IP mode of WAN, for example
  - ✧ static, static IP
  - ✧ DHCP, dynamic IP
- address.: WAN IP address
- mask: WAN subnet mask
- gateway: WAN gateway address

### 4.3.4.21. AT+LANN

Function: Query/Set LAN settings, only valid in AP mode

Format:

Query : AT+LANN<CR>

+ok=<address,mask ><CR>< LF ><CR>< LF >

Setting: AT+ LANN=<address,mask ><CR>

+ok<CR>< LF ><CR>< LF >

Parameters:

- address.: LAN IP address
- mask: LAN subnet mask

Note: The address of the WAN port of the module viewed by WANN and the address of the LAN port of the module viewed by LANN. The two IPs cannot be set on the same network segment, otherwise the module does not work properly.

### 4.3.4.22. AT+TCPTO

Function: Query/Set TCP timeout

Format:

Query : AT+ TCPTO<CR>

+ok=<time><CR>< LF ><CR>< LF >

Setting: AT+ TCPTO=<time ><CR>

+ok<CR>< LF ><CR>< LF >

Parameters:

- time.: TCP timeout, <= 600 (600s), >=0 (0 means no timeout), default is 0.

TCP timeout: The module TCP channel starts counting when no data is received, and clears the count when data is received. If the timing exceeds the TCPTO time, the connection is disconnected. When the module works on the TCP Client, it will actively reconnect to TCP Server. When as a TCP server, TCP client needs to actively reconnect.

### 4.3.4.23. AT+MAXSK

Function: Query /Set the maximum number of TCP connections

Format:

Query : AT+ MAXSK<CR>

+ok=<num><CR>< LF ><CR>< LF >

Setting: AT+ MAXSK =<num ><CR>

+ok<CR>< LF ><CR>< LF >

Parameters:

- num: maximum number of TCP connections, range: 1~24, default is 24.

When set to TCP Server, the module can support a maximum of 24 TCP connections. If users do not need so many connections, can set to reduce appropriately.

### 4.3.4.24. AT+TCPB

Function: Enable/Disable socket B.

Format:

Query : AT+TCPB <CR>

+ok=<sta.><CR>< LF ><CR>< LF >

Setting: AT+ TCPB=<on/off><CR>

+ok<CR>< LF ><CR>< LF >

Parameters:

- When querying, sta.: Returns whether socket B is enabled.

✧ on, enable

✧ off, disable

After restarting the module, parameters take effect.

### 4.3.4.25. AT+TCPPTB

Function: Query/Set TCPB port number

Format:

Query : AT+TCPPTB <CR>

+ok=<port><CR>< LF ><CR>< LF >

Setting: AT+ TCPPTB=<port><CR>

+ok<CR>< LF ><CR>< LF >

Parameters:

- port: Protocol port, decimal number, less than 65535

After restarting the module, parameters take effect.

### 4.3.4.26. AT+TCPADDB

Function: Query/Set TCPB server address

Format:

Query : AT+TCPADDB <CR>

+ok=<add><CR>< LF ><CR>< LF >

Setting: AT+ TCPADDB=<add><CR>

+ok<CR>< LF ><CR>< LF >

Parameters:

- add: TCPB server address (server's IP address, or a domain name)

After restarting the module, parameters take effect.

### 4.3.4.27. AT+TCPTOB

Function: Query/Set TCPB timeout

Format:

Query : AT+ TCPTOB<CR>

+ok=<time><CR>< LF ><CR>< LF >

Setting: AT+ TCPTOB=<time ><CR>

+ok<CR>< LF ><CR>< LF >

Parameters:

- time.: TCPB timeout, <= 600 (600s), >=0 (0 means no timeout), default is 0.

#### 4.3.4.28. AT+TCPLKB

Function: Query whether TCPB connection is established

Format:

AT+ TCPLKB<CR>

+ok=<sta><CR>< LF ><CR>< LF >

Parameters:

- sta.: returns whether TCOB is established.
- ✧ on, established
  - ✧ off, not established

#### 4.3.4.29. AT+EPHY

Function: Enable/Disable Ethernet interface.

Format:

Setting: AT+ EPHY<CR>

+ok<CR>< LF ><CR>< LF >

Parameters:

After sending this command, enable the Ethernet interface. This command is not saved, that is, Ethernet is still disabled after restart. If need to save this setting, please use the factory setting command. If need to enable the Ethernet interface permanently, please use the “AT + FEPHY = on” command.

After the Ethernet interface is closed, the power consumption of the module can be reduced, so it is recommended to set it to off when the Ethernet interface is not used. The Ethernet interface is enabled by default.

With “AT + FVEW = disable / enable”, set the Ethernet interface to LAN port (disable) or WAN port (enable). This command will take effect after restoring the factory settings.

#### 4.3.4.30. AT+FUDLX

Function: Enable/Disable RS485

Format:

AT+FUDLX=on/off<CR>

+ok<CR>< LF ><CR>< LF >

This command enables or disables the RS485 interface. By default, RS485 is enabled, and the 485 control pin is RTS. This command takes effect after restoring factory settings.

### 4.3.4.31. AT+AABR

Function: Enable/Disable RFC2217 function

Format:

```
AT+AABR=on/off<CR>
```

```
+ok<CR>< LF ><CR>< LF >
```

This command enables or disables synchronization (RFC2217) function, default is enabled.

### 4.3.4.32. AT+DHCPDEN

Function: Enable/Disable DHCP server function of LAN port

Format:

```
AT+DHCPDEN=on/off<ID><CR>
```

```
+ok=<ID><CR>< LF ><CR>< LF >
```

Parameters:

This command enables or disables DHCP server function of LAN port, default is enabled.

### 4.3.4.33. AT+HIDESSID

Function: Enable/Disable hiding the SSID in AP mode.

Format:

```
AT+HIDESSID=on/off<CR>
```

```
+ok<CR>< LF ><CR>< LF >
```

This command enables or disables hiding the SSID of the module in AP mode. Default is disabled.

### 4.3.4.34. AT+DOMAIN

Function: Query/Set web server domain name

Format:

Query : AT+ DOMAIN<CR>

```
+ok=<name><CR>< LF ><CR>< LF >
```

Setting: AT+ DOMAIN=<name ><CR>

```
+ok<CR>< LF ><CR>< LF >
```

Parameters:

➤ name: web server domain name



### 4.3.4.35. AT+RELD

Function: Reset the module

Format:

AT+RELD<CR>

+ok=rebooting...<CR>< LF ><CR>< LF >

This command restores the factory settings of the module, then the module will restart automatically.

### 4.3.4.36. AT+Z

Function: restart the module

Format:

AT+Z<CR>

Module restarts.

### 4.3.4.37. AT+MID

Function: Query module's MID

Format:

Query : AT+MID<CR>

+ok=<module\_id><CR>< LF ><CR>< LF >

Parameters:

- module\_id: module MID, Format
  - ✧ A11-yymmddnnnn
- yymmdd: Represents the production date, year, month and day
- nnnn: Indicates the production serial number

### 4.3.4.38. AT+VER

Function: Query firmware version

Format:

Query : AT+VER<CR>

+ok=<ver><CR>< LF ><CR>< LF >

Parameters:

- ver: returns firmware version of module.

### 4.3.4.39. AT+H

Function: Help command

Format:

Query : AT+H<CR>

+ok=<commod help><CR>< LF ><CR>< LF >

Parameters: commod help: Command line instructions

### 4.3.4.40. AT+WSQY

Function: Query/Set RSSI threshold(percentage) to switch among three AP in STA mode

Format:

Query : AT+ WSQY<CR>

+ok=<ret><CR>< LF ><CR>< LF >

Setting: AT+ WSQY=< ret><CR>

+ok<CR>< LF ><CR>< LF >

Parameters:

- ret:
- The percentage of RSSI threshold. If the RSSI threshold is 50%, the setting should be “AT + WSQY = 50 <CR>”

Note: If set to 100, the module will not switch WIFI network automatically. If the customer uses only one STA parameter, be sure to set this parameter to 100.

### 4.3.4.41. AT+HTPMODE

Function: Query/Set HTTP Client mode parameters configuration way (new/old)

Format:

Query : AT+HTPMODE<CR>

+ok=<type><CR>< LF ><CR>< LF >

Setting: AT+ HTPMODE=<type><CR>

+ok<CR>< LF ><CR>< LF >

Parameters:

- type: Authentication mode, including
  - ✧ new : New HTTP Client mode parameters configuration way
  - ✧ old: old HTTP Client mode parameters configuration way

This parameter is only valid in HTTPD Client mode. Takes affect after restarting the module. But this parameter can also be set in other modes.

#### 4.3.4.42. AT+HTTPURL

Function: Query/Set IP address and port of HTTP server (old).

Format:

Query : AT+ HTTPURL<CR>

+ok=<ip>,<port><CR>< LF ><CR>< LF >

Setting: AT+ HTTPURL=<ip>,<port><CR>

+ok<CR>< LF ><CR>< LF >

Parameters:

- ip: IP address of HTTP server.
- port: port number of HTTP server.

#### 4.3.4.43. AT+HTTPTP

Function: Query/Set HTTP requesting type in HTTP Client mode (old).

Format:

Query : AT+ HTTPTP<CR>

+ok=<Type><CR>< LF ><CR>< LF >

Setting: AT+ HTTPTP=<Type><CR>

+ok<CR>< LF ><CR>< LF >

Parameters:

- Type: HTTP requesting type, including
  - ✧ GET
  - ✧ PUT
  - ✧ POST

#### 4.3.4.44. AT+HTTTPH

Function: Query/Set HTTP header path (old).

Format:

Query : AT+ HTTTPH<CR>

+ok=<path><CR>< LF ><CR>< LF >

Setting: AT+ HTTTPH=<path><CR>

+ok<CR>< LF ><CR>< LF >

Parameters:

- path: HTTP header path.

#### 4.3.4.45. AT+HTTPCN

Function: Query/Set HTTP header connection mode (old).

Format:

Query : AT+ HTTPCN<CR>

+ok=<Connection><CR>< LF ><CR>< LF >

Setting: AT+ HTTPCN=<Connection><CR>

+ok<CR>< LF ><CR>< LF >

Parameters:

- Connection: HTTP header connection.

#### 4.3.4.46. AT+HTTPIUA

Function: Query/Set HTTP header User-Agent (old).

Format:

Query : AT+ HTTPIUA<CR>

+ok=<User-Agent><CR>< LF ><CR>< LF >

Setting: AT+ HTTPIUA=<User-Agent><CR>

+ok<CR>< LF ><CR>< LF >

Parameters:

- User-Agent: HTTP header User-Agent.

#### 4.3.4.47. AT+HTPSV

Function: Query/Set HTTP server address and port number (new).

Format:

Query : AT+ HTPSV<CR>

+ok=<ip>,<port><CR>< LF ><CR>< LF >

Setting: AT+ HTPSV=<ip>,<port><CR>

+ok<CR>< LF ><CR>< LF >

Parameters:

- ip: HTTP server IP address

- port: HTTP server IP port

This parameter is only valid in HTTPD Client mode, takes affect after restarting the module. But can also be set in other modes.

#### 4.3.4.48. AT+HTPTP

Function: Query/Set HTTP requesting type (new).

Format:

Query : AT+ HTPTP<CR>

+ok=<Type><CR>< LF ><CR>< LF >

Setting: AT+ HTPTP=<Type><CR>

+ok<CR>< LF ><CR>< LF >

Parameters:

- Type: HTTP requesting type, including
  - ✧ GET
  - ✧ PUT
  - ✧ POST

This parameter is only valid in HTTPD Client mode, takes affect after restarting the module. But can also be set in other modes.

#### 4.3.4.49. AT+HTPURL

Function: Query/Set HTTP URL (new).

Format:

Query : AT+ HTPURL<CR>

+ok=<path><CR>< LF ><CR>< LF >

Setting: AT+ HTPURL=<path><CR>

+ok<CR>< LF ><CR>< LF >

Parameters:

- path: HTTP requesting path.

#### 4.3.4.50. AT+HTPHEAD

Function: Query/Set HTTP header (new).

Format:

Query : AT+ HTPHEAD<CR>

+ok=<head><CR>< LF ><CR>< LF >

Setting: AT+ HTPHEAD=<head><CR>

+ok<CR>< LF ><CR>< LF >

Parameters:

- head: HTTP header content. "Enter" in header should be replaced by "<<CRLF>>", up to 200 bytes.

### 4.3.4.51. AT+REGEN

Function: Query/Set registration package type

Format:

Query : AT+ REGEN<CR>

+ok=<mode><CR>< LF ><CR>< LF >

Setting: AT+ REGEN=<mode><CR>

+ok<CR>< LF ><CR>< LF >

Parameters:

- mode: registration packet type, including
  - ✧ mac: registration package is MAC address
  - ✧ cloud: USR Cloud
  - ✧ usr: user custom registration package
  - ✧ off: Disable registration package function

For example: AT+REGEN=MAC

### 4.3.4.52. AT+REGTCP

Function: Query/Set registration package sending type

Format:

Query : AT+ REGTCP<CR>

+ok=<type><CR>< LF ><CR>< LF >

Setting: AT+ REGTCP=<type><CR>

+ok<CR>< LF ><CR>< LF >

Parameters:

- type: registration package sending type, including
  - ✧ first: sending when establish a connection
  - ✧ every: sending when data is sent every time

### 4.3.4.53. AT+WTPWR

Function: Set module's transmit power

Format:

Query : AT+ WTPWR <CR>

+ok=<sta.><CR>< LF ><CR>< LF >

Setting: AT+ WTPWR =<sta><CR>

+ok<CR>< LF ><CR>< LF >

Parameters:

- sta.: module's transmit power, ranging from 0 to 100. Default is 100.

### 4.3.4.54. AT+REGCLOUD

Function: Query/Set USR Cloud ID and password.

Format:

Query : AT+REGCLOUD<CR>

+ok=<name,password><CR><LF><CR><LF>

Setting: AT+REGCLOUD=<name,password><CR>

+ok<CR>< LF ><CR>< LF >

Parameters:

- name: device ID, 20 digits.
- password: password, up to 8 digits.

For example: AT+REGCLOUD=00004219000000000600,123456

### 4.3.4.55. AT+REGUSR

Function: Query/Set user custom registration package content

Format:

Query : AT+REGUSR<CR>

+ok=<usr><CR><LF><CR><LF>

Setting: AT+REGUSR=<usr><CR>

+ok<CR>< LF ><CR>< LF >

Parameters:

- Usr: Length is limited to 40 characters, HEX format.

For example: set the registration package content to: [www.usr.cn](http://www.usr.cn), "77 77 77 2E 75 73 72 2E 63 6E" in HEX

---

AT+REGUSR=7777772E7573722E636E

#### 4.3.4.56. AT+TCPDPEN

Function: Enable/Disable socket distribution function

Format:

Query : AT+TCPDPEN <CR>

+ok=<sta.><CR>< LF ><CR>< LF >

Setting: AT+ TCPDPEN =<on/off><CR>

+ok<CR>< LF ><CR>< LF >

Parameters:

- When querying, sta.: returns whether socket distribution function is enabled, including

- ✧ on, enabled

- ✧ off, disabled

Parameter takes affect after restarting the module.

#### 4.3.4.57. AT+HEARTEN

Function: Enable/Disable heartbeat package function.

Format:

Query : AT+HEARTEN <CR>

+ok=<sta.><CR>< LF ><CR>< LF >

Setting: AT+ HEARTEN =<on/off><CR>

+ok<CR>< LF ><CR>< LF >

Parameters:

- When querying, sta.: returns whether heartbeat package is enabled. including

- ✧ on, heartbeat package function is enabled

- ✧ off, heartbeat package function is disabled

Parameter takes affect after restarting the module.

#### 4.3.4.58. AT+HEARTTP

Function: Query/Set heartbeat package sending type.

Format:

Query : AT+HEARTTP <CR>



```
+ok=<sta.><CR>< LF ><CR>< LF >
```

Setting: AT+ HEARTTP =<NET/COM><CR>

```
+ok<CR>< LF ><CR>< LF >
```

Parameters:

- When querying, sta.: returns heartbeat package sending type, including
  - ✧ NET, heartbeat package is sent to network
  - ✧ COM, heartbeat package is sent to serial port

Parameter takes affect after restarting the module.

### 4.3.4.59. AT+HEARTDT

Function: Query/Set heartbeat package data

Format:

Query : AT+HEARTDT<CR>

```
+ok=<usr><CR><LF><CR><LF>
```

Setting: AT+HEARTDT=<usr><CR>

```
+ok<CR>< LF ><CR>< LF >
```

Parameters:

- usr: Length is limited to 40 characters. HEX format.  
For example: heartbeat package data: [www.usr.cn](http://www.usr.cn), "77 77 77 2E 75 73 72 2E 63 6E" in HEX.  
AT+REGUSR=7777772E7573722E636E

### 4.3.4.60. AT+HEARTTM

Function: Query/Set heartbeat package sending interval

Format:

Query : AT+ HEARTTM<CR>

```
+ok=<time><CR>< LF ><CR>< LF >
```

Setting: AT+ HEARTTM=<time ><CR>

```
+ok<CR>< LF ><CR>< LF >
```

Parameters:

- time.: heartbeat package sending interval, 1~65535s, default is 30s.

### 4.3.4.61. AT+REBOOTEN

Function: Enable/Disable timing restart function

Format:

Query : AT+REBOOTEN<CR>

+ok=<sta.><CR>< LF ><CR>< LF >

Setting: AT+ REBOOTEN=<on/off><CR>

+ok<CR>< LF ><CR>< LF >

Parameters:

➤ When querying, sta.: returns whether timing restart function is enabled, including

✧ on, timing restart function is enabled

✧ off, timing restart function is disabled

Parameter takes affect after restarting the module.

### 4.3.4.62. AT+REBOOTT

Function: Query/Set timing restart time

Format:

Query : AT+ REBOOTT<CR>

+ok=<time><CR>< LF ><CR>< LF >

Setting: AT+ REBOOTT=<time ><CR>

+ok<CR>< LF ><CR>< LF >

Parameters:

➤ time.: timing restart time, 1-720h, default is 24h.

### 4.3.4.63. AT+TIMEOUTEN

Function: Enable/Disable timeout restart function

Format:

Query : AT+TIMEOUTEN<CR>

+ok=<sta.><CR>< LF ><CR>< LF >

Setting: AT+ TIMEOUTEN=<on/off><CR>

+ok<CR>< LF ><CR>< LF >

Parameters:

➤ When querying, sta.: returns whether timeout restart function is enabled, including

✧ on, timeout restart function is enabled

✧ off, timeout restart function is disabled

Parameter takes affect after restarting the module.

#### 4.3.4.64. AT+TIMEOUTT

Function: Query/Set timeout restart time

Format:

Query : AT+ TIMEOUTT<CR>

+ok=<time><CR>< LF ><CR>< LF >

Setting: AT+ TIMEOUTT=<time ><CR>

+ok<CR>< LF ><CR>< LF >

Parameters:

- time.: timeout restart time, 60-65535s, default is 3600s.

#### 4.3.4.65. AT+FAPSTA

Function: Enable/Disabled AP+STA function

Format:

AT+FAPSTA=on/off<CR>

+ok<CR>< LF ><CR>< LF >

This command enables or disables AP+STA function, default is disabled. Parameter takes affect after restarting the module.

#### 4.3.4.66. AT+HTTPSCEN

Function: Query/Set HTTPD Client mode: long/short

Format:

Query : AT+HTTPSCEN <CR>

+ok=<mode><CR>< LF ><CR>< LF >

Setting: AT+HTTPSCEN =<mode><CR>

+ok<CR>< LF ><CR>< LF >

Parameters:

- mode: HTTPD Client mode, including
  - long: long connection mode
  - short: short connection mode

Parameter takes affect after restarting the module.

#### 4.3.4.67. AT+MODBPOLLEN

Function: Enable/Disable Modbus polling function

Format:

AT+MODBPOLLEN =on/off<CR>

+ok<CR>< LF ><CR>< LF >

Default is "off". Parameter takes affect after restarting the module.

#### 4.3.4.68. AT+UPDATE

Function: Query/Set remote upgrade parameters.

Format:

Query : AT+UPDATE<CR>

+ok=<state, server address, server port, interval ><CR>< LF ><CR>< LF >

Setting: AT+ UPDATE =< state, server address, server port, interval ><CR>

+ok<CR>< LF ><CR>< LF >

Parameters:

- state: status,
  - ✧ on/off
- server address: server address
  - ✧ default: ycsj1.usr.cn
- server port: server port
  - ✧ Default: 30001
- interval: reporting interval
  - ✧ Default is 30min, maximum time interval (max): 120min

Parameter takes affect after restarting the module.

### 4.3.4.69.AT+MONITOR

Function: Query/Set remote monitoring parameters

Format:

Query : AT+ MONITOR <CR>

+ok=< state , interval ><CR>< LF ><CR>< LF >

Setting: AT+ MONITOR=< state , interval ><CR>

+ok <CR>< LF ><CR>< LF >

Parameters:

- state: status
  - ✧ on/off
- interval: reporting interval
  - ✧ default is 10min, maximum time interval (max): 120min

Parameter takes affect after restarting the module.

## 5. Contact us

Company: Jinan USR IOT Technology Co., Ltd

Address: Floor 11,Building1,No.1166 Xinluo Street,Gaoxin Distric,Jinan,Shandong,250101 China

Tel: 86-531-55507297 86-531-88826739-803

Web: <http://www.usriot.com/>

Skype: lisausr

Support: <http://h.usriot.com/index.php?c=frontTicket&m=sign>

Email: sales@usr.cn tec@usr.cn

## 6. Disclaimer

The document provides information about USR-W610 module, it doesn't grant any license to the intellectual property rights. Except the responsibility declared in the product sale clause, USR does not assure any other responsibilities. In addition, USR does not make any warranties for the sale and use of this product, including the suitability of products for a particular purpose, merchant ability or fitness for any patent, copyright or other intellectual property infringement. USR may make changes to specifications and products description without notice.

